

# ASSEMBLY INSTRUCTIONS

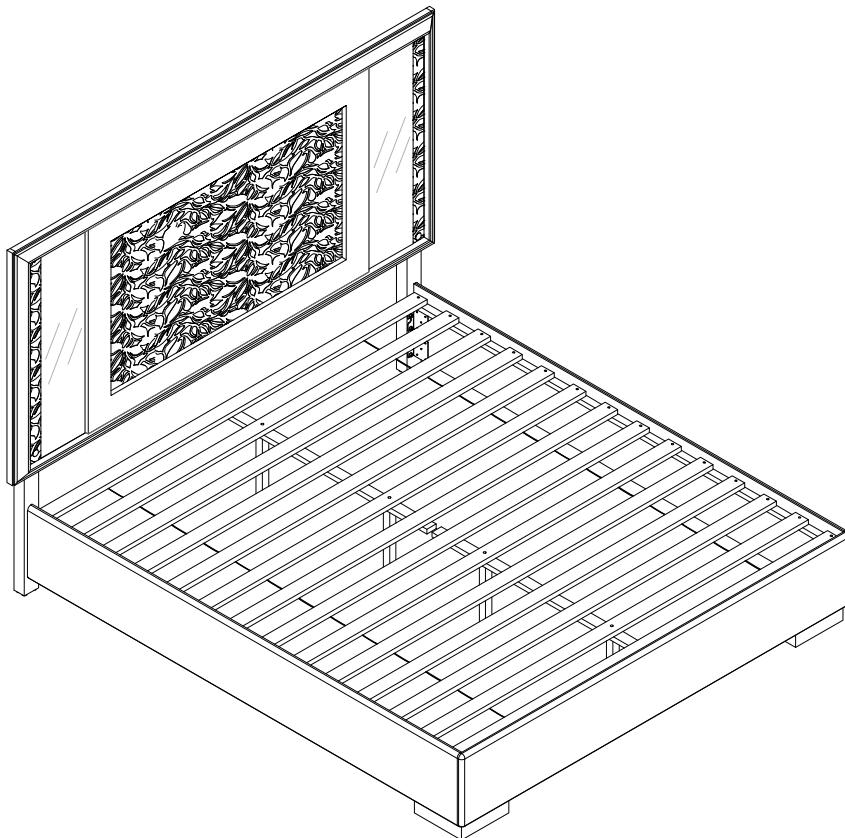

## TOOLS REQUIRED

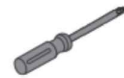

Screwdriver  
( Not included)

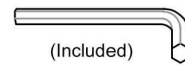

(Included)  
Allen Wrench



2 - People

## ASSEMBLY RATING



EASY —————> DIFFICULT

The Assembly Rating is a 5-point system showing the level of effort needed to assemble a specific product.



## **CHECK BEFORE STARTING**

### **Are you missing anything?**

Double-check all parts, hardware and accessories listed are all accounted for.

### **Check out our Quick Tips!**

We recommend reviewing the pre-assembly handouts. Even experts need a refresher now and then!

### **Should we send any replacements?**

Are there any irregularities or flaws in the parts? We can send replacements!

### **Prep Time!**

Please review the assembly instructions and all diagrams prior to assembling.

# PRE ASSEMBLY INTRODUCTION

We understand building ready-to-assemble furniture can be a challenging experience for some. To help avoid confusion, we have provided some helpful tips that may speed up the process.



## Teamwork

ALWAYS have at least two people to help with transporting and assembling the product to avoid potential injury and/or damage.

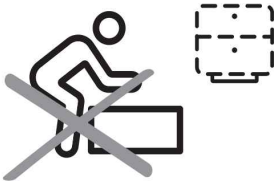

## Suitable Location

Assembling near the area of the intended location is highly recommended.



## Sufficient Space

Make sure you have enough space to move around during the assembly.



## Avoid Scratches

Use cardboard, blankets or a carpeted area while assembling furniture to prevent to prevent scratches and damages.

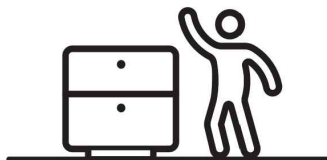

## Flat Surface

Make sure the furniture rests on a flat and level surface with each leg evenly touching the floor.

# ASSEMBLY AND CARE ADVICE



**FAILURE TO FOLLOW THE GUIDELINES BELOW MAY RESULT IN INJURY AND/OR PROPERTY DAMAGE.**



Position each part correctly and insert screws or bolts into their respective holes.



Turn clockwise to tighten and only tighten when step is completed or when instructed to do so.



Use the appropriate hand tools or power tools for assembly. Select steps, such as tightening screws and/or bolts, may require hand tools to avoid causing damage during assembly.



Save the instructions and store any supplied tools for later maintenance.

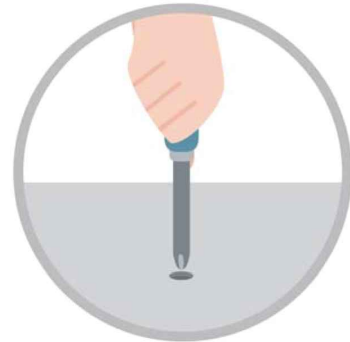

After two weeks, check and tighten any loose hardware and repeat again every six months thereafter.

**IT IS THE USER'S RESPONSIBILITY TO MAINTAIN THE FURNITURE. THE HARDWARE MAY LOOSEN OVER TIME AND MAY CAUSE THE FURNITURE TO BE WOBBLY AND UNABLE TO SUPPORT ITS INTENDED WEIGHT CAPACITY. THIS MAY LEAD TO COLLAPSE AND MAY CAUSE SERIOUS INJURY.**

# QUEEN BED

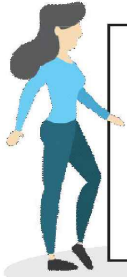

- Please keep instructions for future reference.
- Check the quantity and irregularity of parts and hardware before you start.

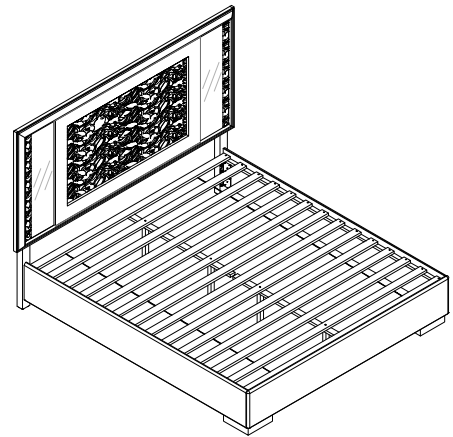

## PARTS

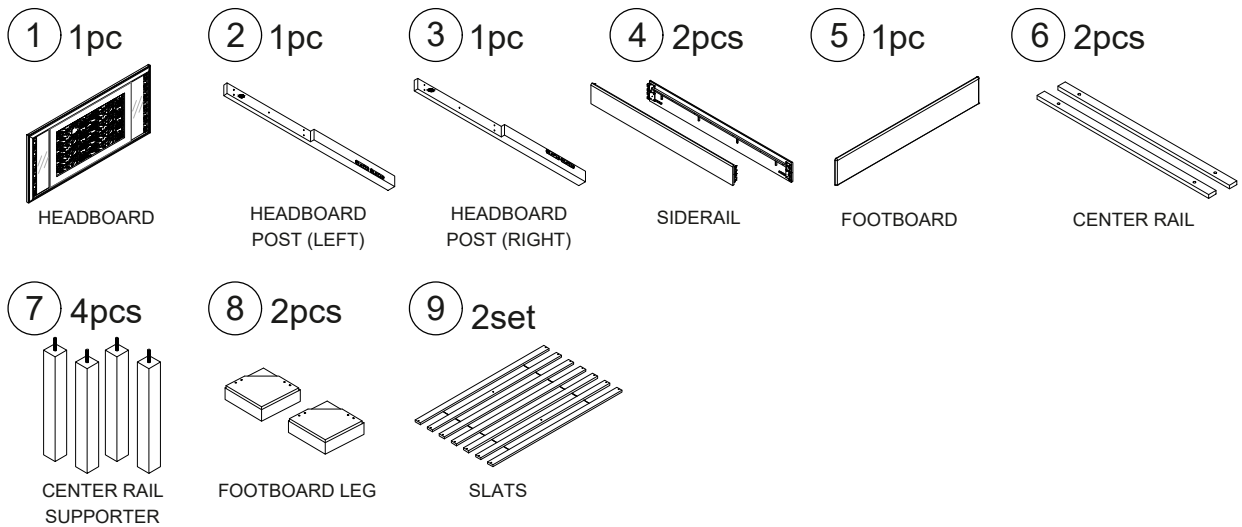

## HARDWARE



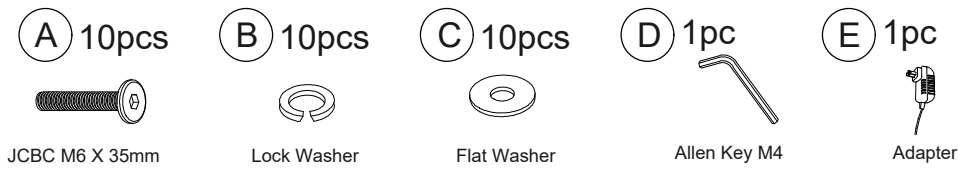



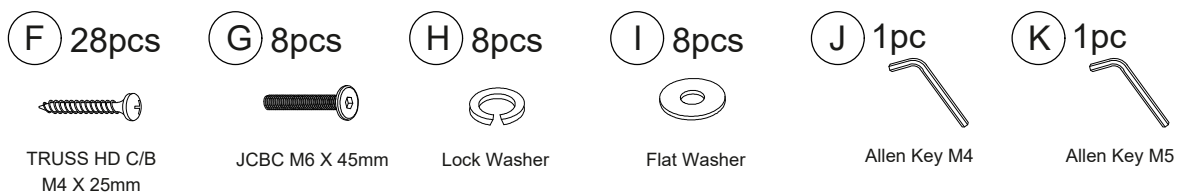



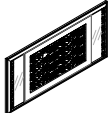

### HARDWARE INSIDE HEADBOARD

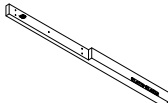
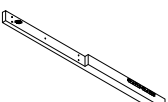
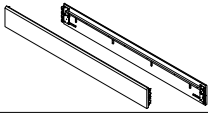

### HARDWARE INSIDE FOOTBOARD SIDERAIL

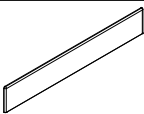
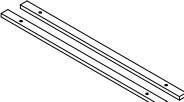
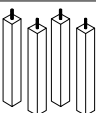
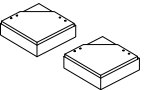
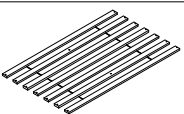

## packed in 2 cartons

Carton	Description		Part	Quantity	Hardware
	HEADBOARD	①		X1	 A x10pcs  B x10pcs  C x10pcs  D x1pc  E x1pc
	HEADBOARD POST (LEFT)	②		X1	
	HEADBOARD POST (RIGHT)	③		X1	
	SIDERAIL	④		X2	 F x28pcs  G x8pcs  H x8pcs  I x8pcs  J x1pc  K x1pc
	FOOTBOARD	⑤		X1	
	CENTER RAIL	⑥		X2	
	CENTER RAIL SUPPORTER	⑦		X4	
	FOOTBOARD LEG	⑧		X2	
	SLATS	⑨		X2	

# ASSEMBLY INSTRUCTIONS

## 1

- Part ① x1pc
- Part ② x1pc
- Part ③ x1pc

Align the headboard post (#2L,#3R) to the headboard (#1).

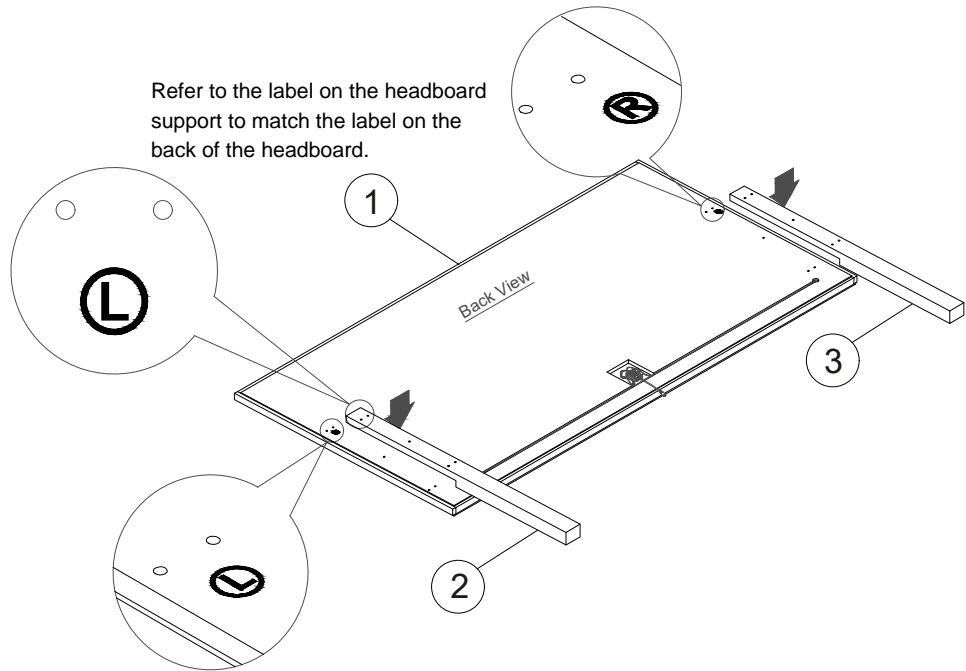

Refer to the label on the headboard support to match the label on the back of the headboard.

## 2

- Part ① x1pc
- Part ② x1pc
- Part ③ x1pc
- Hardware ④ x10pcs
- Hardware ⑤ x10pcs
- Hardware ⑥ x10pc
- Hardware ⑦ x1pc

Use allen key (#D) to attach headboard post (#2L,#3R) to the headboard (#1) by using screw assembly of screw (#A) with lock washer (#B) and flat washer (#C).

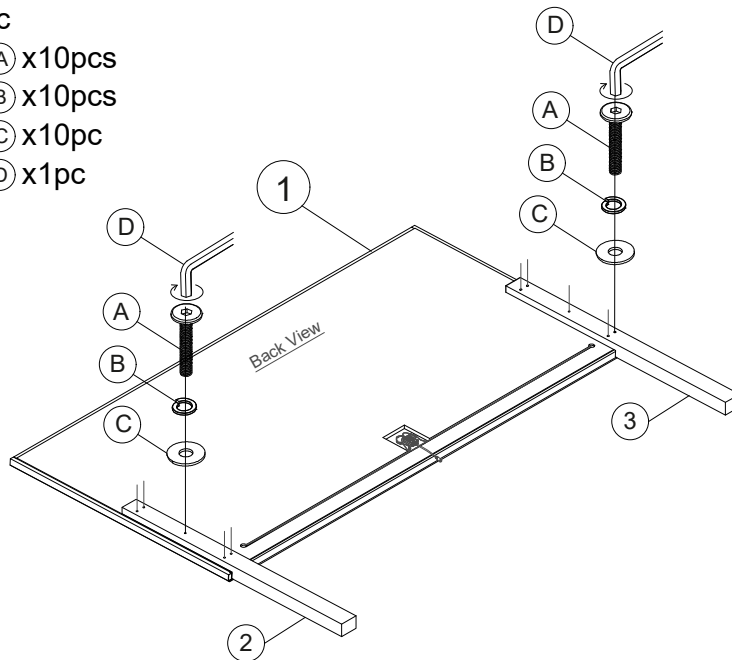

# ASSEMBLY INSTRUCTIONS

## 3

- Part ⑤ x1pc
- Part ⑧ x2pcs
- Hardware ⑥ x2pcs
- Hardware ⑦ x2pcs
- Hardware ⑩ x2pcs
- Hardware ⑪ x1pc

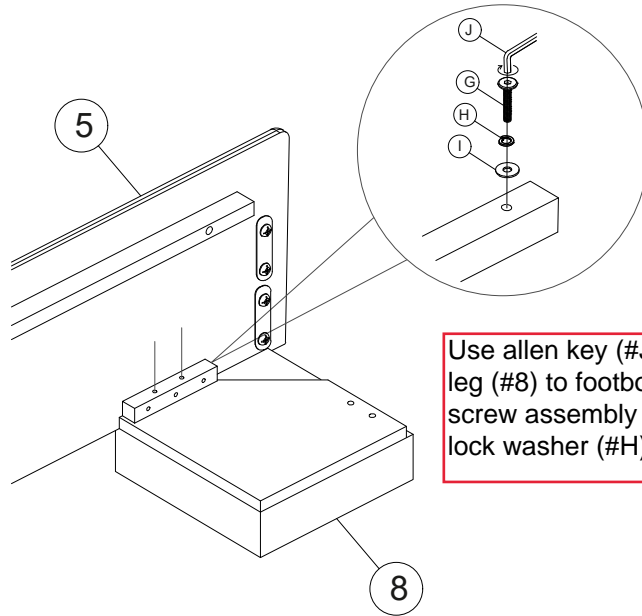

Use allen key (#J) to attach footboard leg (#8) to footboard (#5) by using screw assembly of screw (#G) with lock washer (#H) and flat washer (#I).

## 4

- Part ① x1pc
- Part ④ x2pcs
- Part ⑤ x1pc
- Hardware ⑫ x1pc

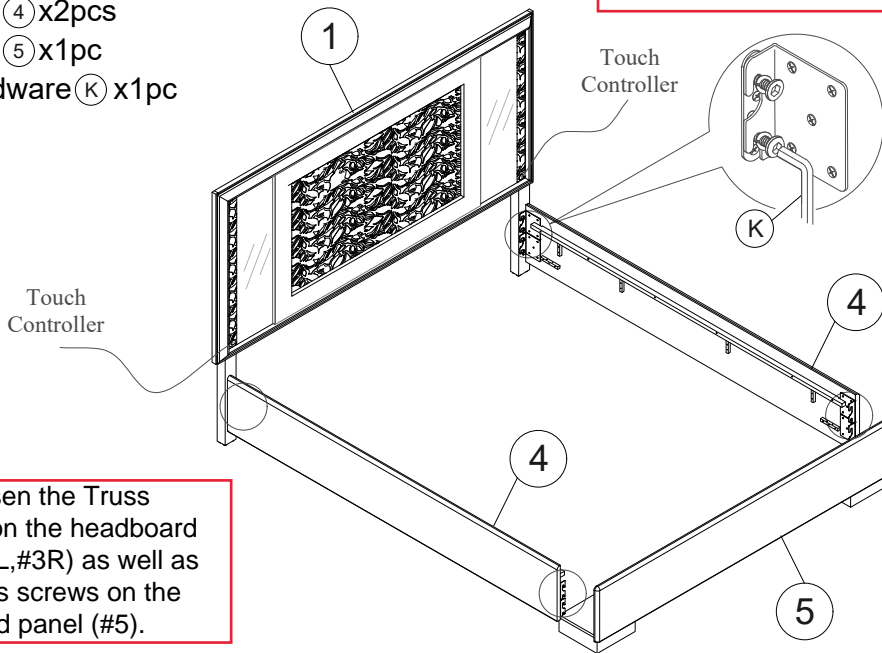

4-2 Hook screw plate attached on the side rail (#4) onto the Truss screws and use the allen key to tighten the Truss screw and secure the side rail (#4) to the headboard post (#2, #3) and footboard (#5).

4-1 Loosen the Truss screws on the headboard post (#2L,#3R) as well as the Truss screws on the footboard panel (#5).

# ASSEMBLY INSTRUCTIONS

## 5

Part ⑥ x2pcs

Part ⑦ x4pcs

Part ⑨ x2set

Align the center rail (#6) on the slats (#9) and secure together by twisting the center rail support (#7) until tight.

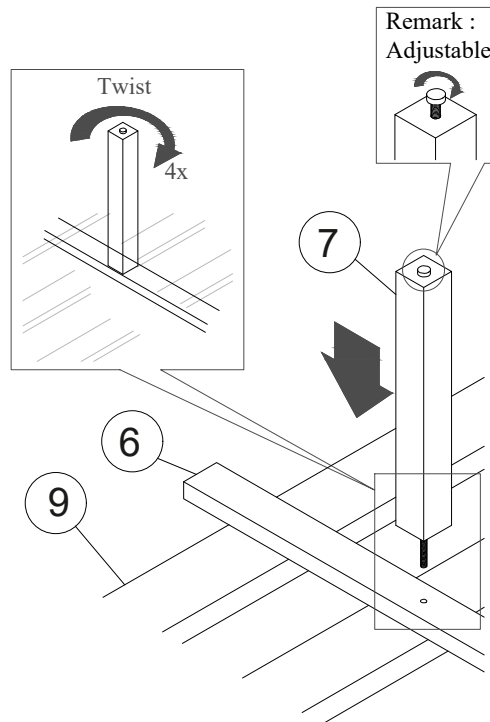

## 6

Part ⑨ x2set

Hardware ① x28pcs

Hardware ② x2pcs

Hardware ③ x2pcs

Hardware ④ x2pcs

Hardware ⑤ x1pc

6-2 Extend the slats (#9) over the side rail (#4) and secure by using screw (#F). Tighten with screwdriver(not included).

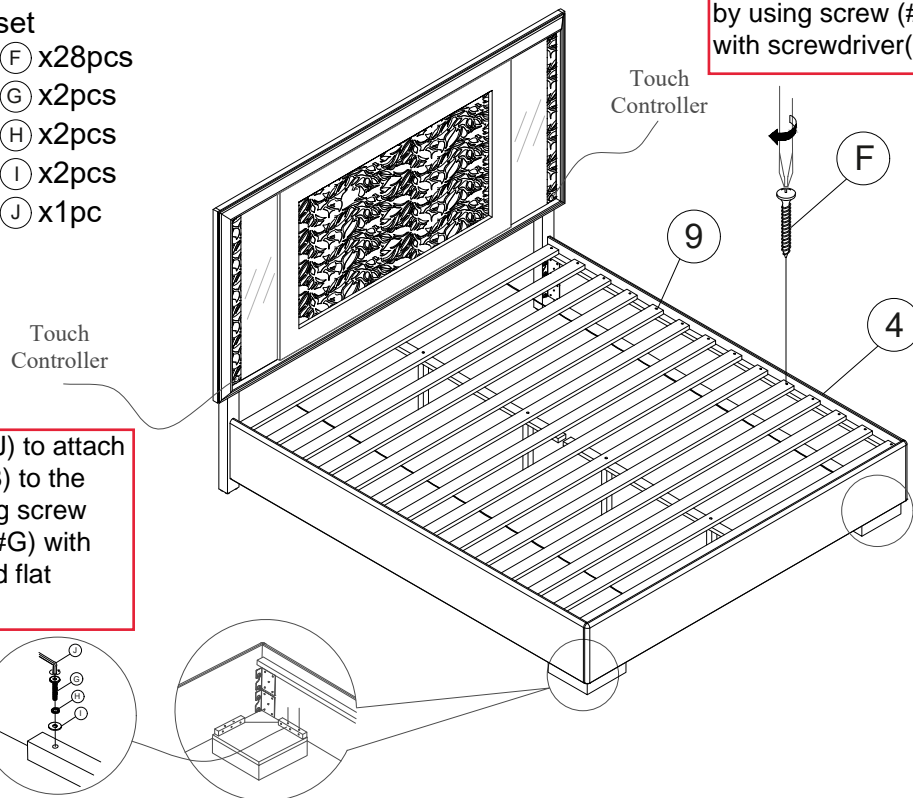

6-1 Use allen key (#J) to attach the footboard leg (#8) to the side rail (#4) by using screw assembly of screw (#G) with lock washer (#H) and flat washer (#I).

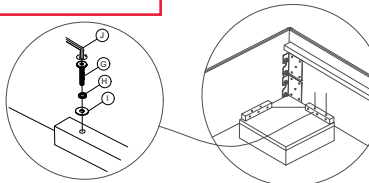

# ASSEMBLY INSTRUCTIONS

## 7

Hardware (E) x1pc

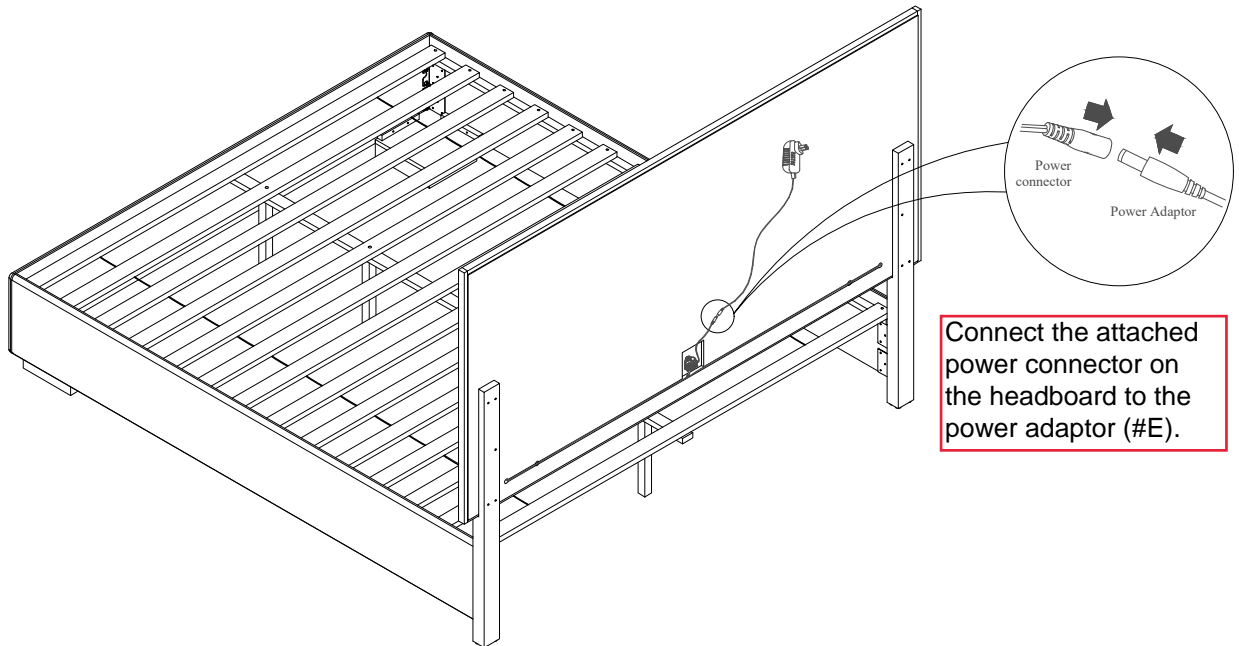

### ASSEMBLY COMPLETED



Please ensure the furniture rests on an even and flat surface. If the product wobbles or feels loose, double-check all bolts and/or screws are properly tightened and secured.

#### ✓ Keep this handy!

Please retain this instruction manual and any order-related information for future reference.

#### ✓ Lift, don't drag!

To avoid damage to product please always LIFT the product when transporting or adjusting the placement.

This product is intended for RESIDENTIAL USE ONLY and not for commercial use.

# ASSEMBLY INSTRUCTIONS

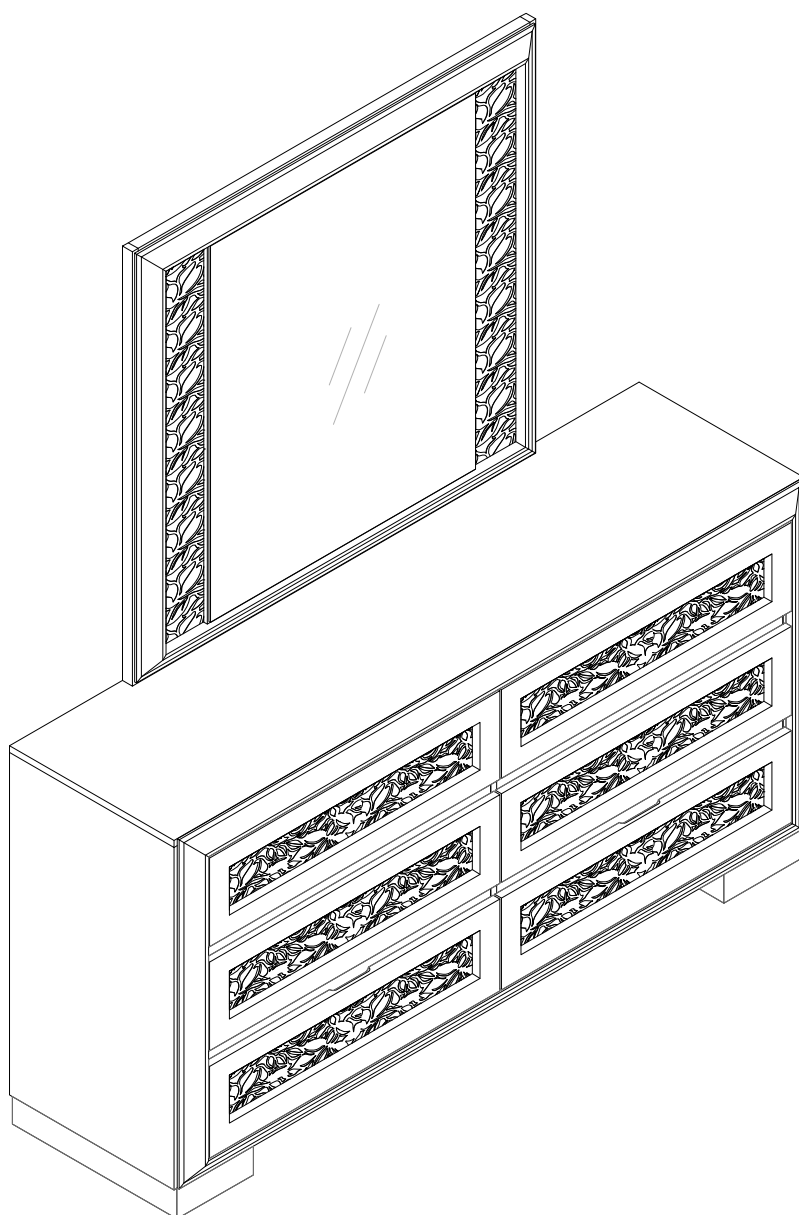

## TOOLS REQUIRED



Screwdriver  
( Not included)



(Included)  
Allen Wrench



2 - People

## ASSEMBLY RATING



EASY —————> DIFFICULT

The Assembly Rating is a 5-point system showing the level of effort needed to assemble a specific product.

VERSION# 24-06-28



## **CHECK BEFORE STARTING**

### **Are you missing anything?**

Double-check all parts, hardware and accessories listed are all accounted for.

### **Check out our Quick Tips!**

We recommend reviewing the pre-assembly handouts. Even experts need a refresher now and then!

### **Should we send any replacements?**

Are there any irregularities or flaws in the parts? We can send replacements!

### **Prep Time!**

Please review the assembly instructions and all diagrams prior to assembling.

# PRE ASSEMBLY INTRODUCTION

We understand building ready-to-assemble furniture can be a challenging experience for some. To help avoid confusion, we have provided some helpful tips that may speed up the process.

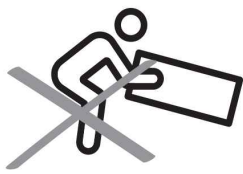

## Teamwork

ALWAYS have at least two people to help with transporting and assembling the product to avoid potential injury and/or damage.

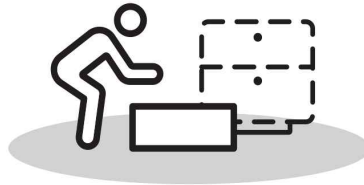
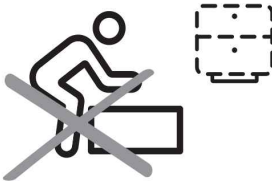

## Suitable Location

Assembling near the area of the intended location is highly recommended.



## Sufficient Space

Make sure you have enough space to move around during the assembly.



## Avoid Scratches

Use cardboard, blankets or a carpeted area while assembling furniture to prevent to prevent scratches and damages.

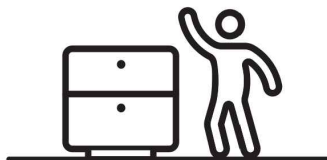
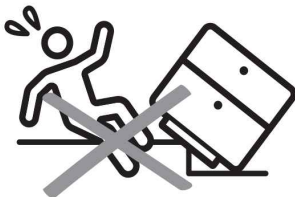

## Flat Surface

Make sure the furniture rests on a flat and level surface with each leg evenly touching the floor.

# ASSEMBLY AND CARE ADVICE



**FAILURE TO FOLLOW THE GUIDELINES BELOW MAY RESULT IN INJURY AND/OR PROPERTY DAMAGE.**



Position each part correctly and insert screws or bolts into their respective holes.

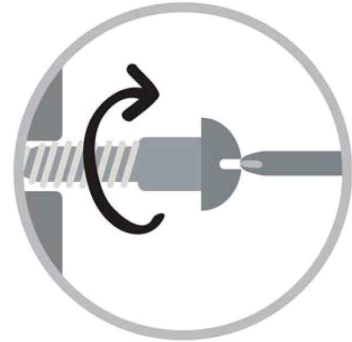

Turn clockwise to tighten and only tighten when step is completed or when instructed to do so.



Use the appropriate hand tools or power tools for assembly. Select steps, such as tightening screws and/or bolts, may require hand tools to avoid causing damage during assembly.



Save the instructions and store any supplied tools for later maintenance.

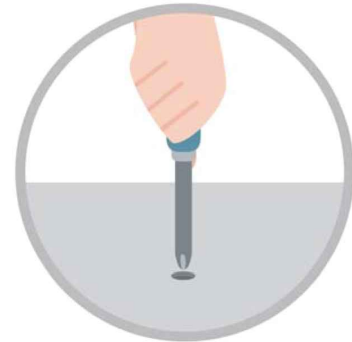

After two weeks, check and tighten any loose hardware and repeat again every six months thereafter.

**IT IS THE USER'S RESPONSIBILITY TO MAINTAIN THE FURNITURE. THE HARDWARE MAY LOOSEN OVER TIME AND MAY CAUSE THE FURNITURE TO BE WOBBLY AND UNABLE TO SUPPORT ITS INTENDED WEIGHT CAPACITY. THIS MAY LEAD TO COLLAPSE AND MAY CAUSE SERIOUS INJURY.**

# MIRROR

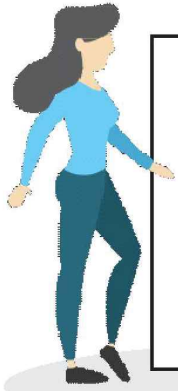

- Please keep instructions for future reference.
- Check the quantity and irregularity of parts and hardware before you start.

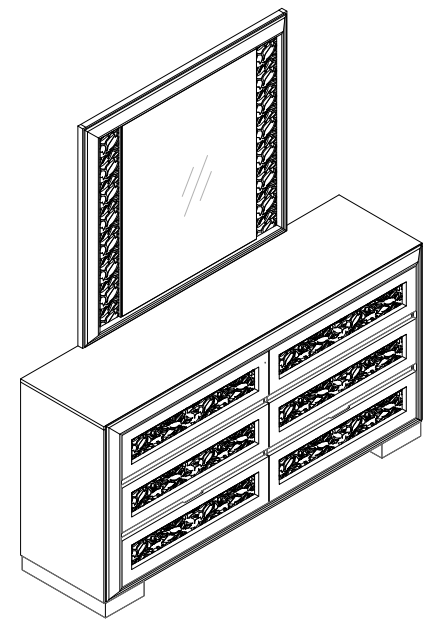

## PARTS

1 1pc

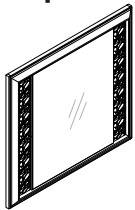

MIRROR

2 2pcs

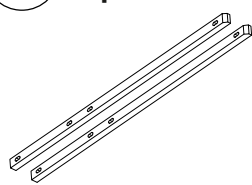

MIRROR SUPPORT

3 1pc

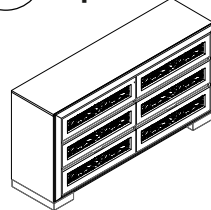

DRESSER

## HARDWARE

### HARDWARE INSIDE MIRROR

A 8pcs

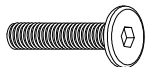

JCBC M6 X 35mm

B 8pcs



Lock Washer

C 8pcs



Flat Washer

D 1pc



Allen Key M4

E 1pc



Adapter





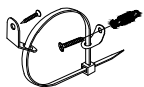



### HARDWARE INSIDE DRESSER

F 1pc

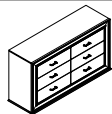

Anti-Tip Kit

**packed in 2 cartons**

Carton	Description	Part		Hardware
	MIRROR	①	 <span style="float: right;">X1</span>	 A x8pcs  B x8pcs  C x8pcs
	MIRROR SUPPORT	②	 <span style="float: right;">X2</span>	 D x1pc  E x1pc
	DRESSER	③	 <span style="float: right;">X1</span>	 F x1pc

# ASSEMBLY INSTRUCTIONS

## 1

- Part ① x1pc
- Part ② x2pcs
- Part ③ x1pc

Align the mirror support (#2) to the mirror (#1).

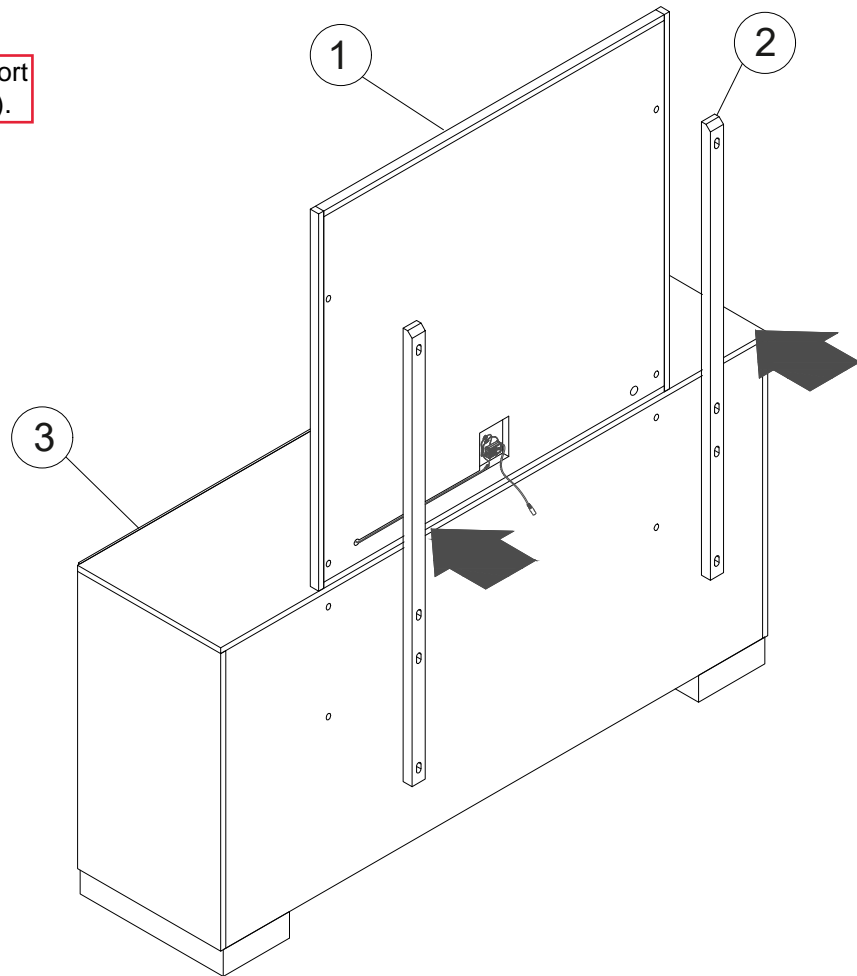

## 2

- Part ① x1pc
- Part ② x2pcs
- Part ③ x1pc
- Hardware (A) x8pcs
- Hardware (B) x8pcs
- Hardware (C) x8pcs
- Hardware (D) x1pc

Secure the top of the mirror support (#2) to the mirror (#1) by using allen key to insert screw assembly of screw (#A) with lock washer (#B) and flat washer (#C). Secure the bottom of the mirror support (#2) to the dresser (#3) by using allen key (#D) to insert screw assembly of screw (#A) with lock washer (#B) and flat washer (#C).

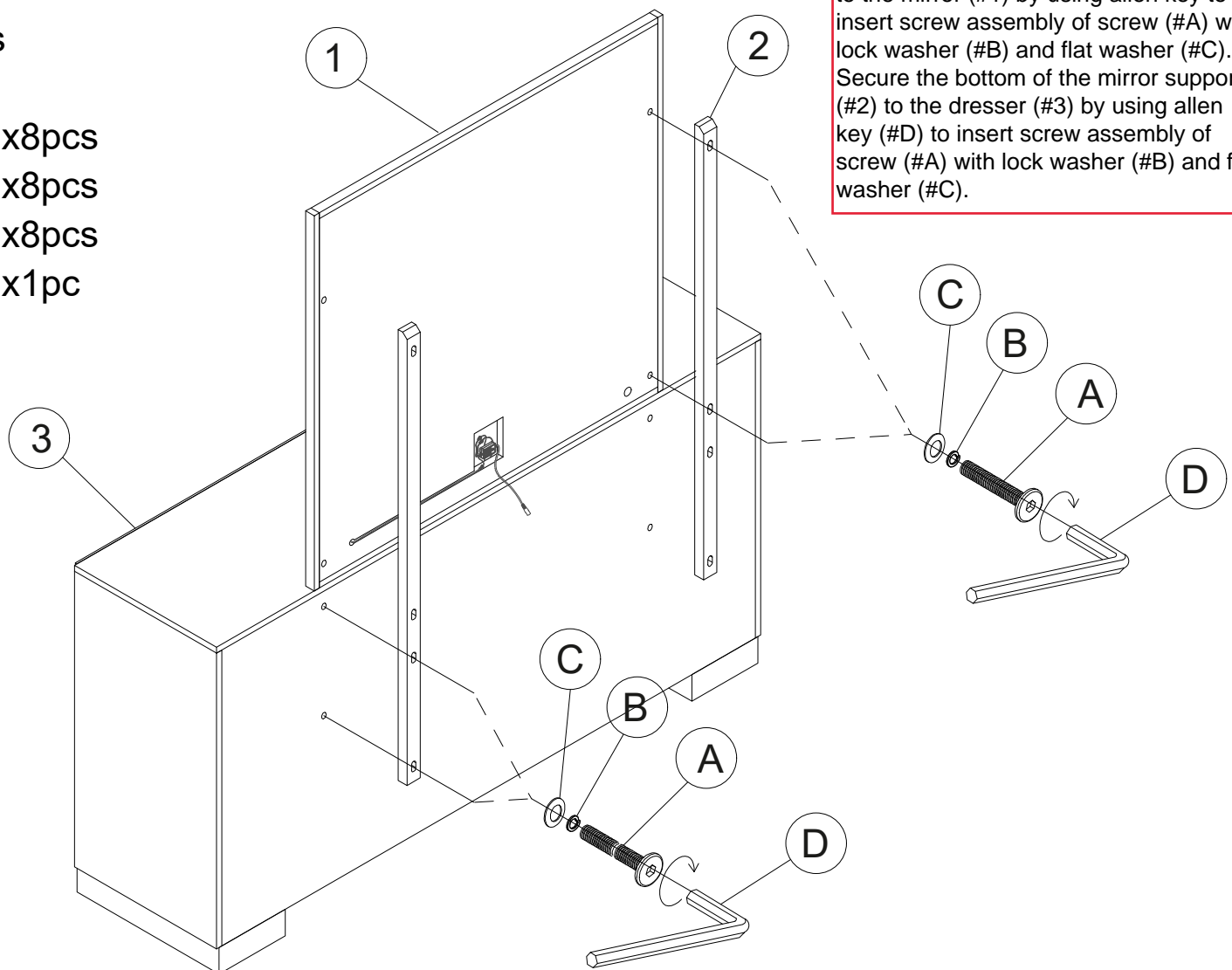

# ASSEMBLY INSTRUCTIONS

**3**  
Hardware (E) x1pc

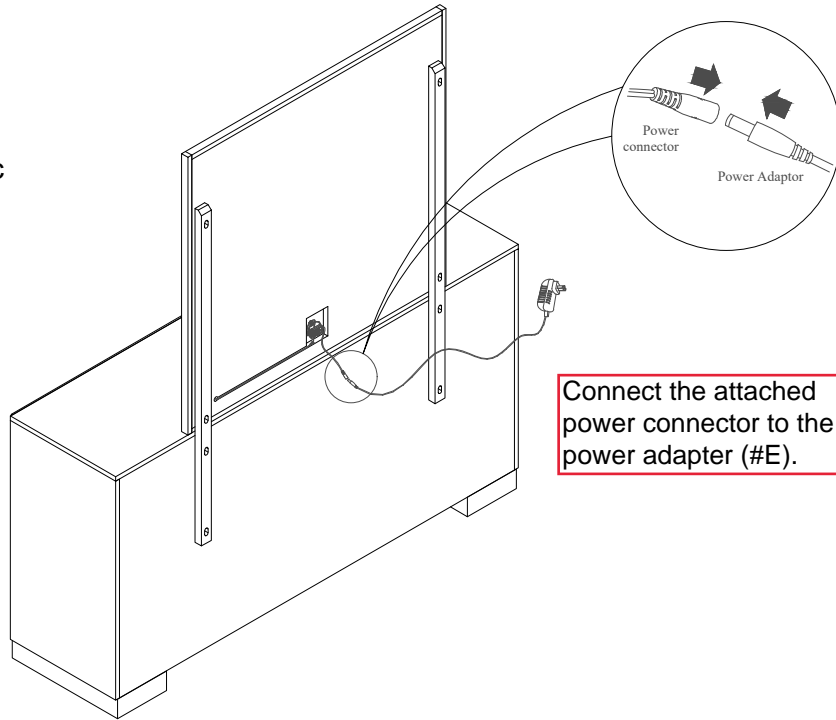

## ASSEMBLY COMPLETED



Please ensure the furniture rests on an even and flat surface. If the product wobbles or feels loose, double-check all bolts and/or screws are properly tightened and secured.

✓ **Keep this handy!**

Please retain this instruction manual and any order-related information for future reference.

✓ **Lift, don't drag!**

To avoid damage to product please always LIFT the product when transporting or adjusting the placement.

This product is intended for RESIDENTIAL USE ONLY and not for commercial use.