

VIVOHOME

**THANK  
YOU!**

**NOTE:**

To continuously improve its products, VIVOHOME reserves the right to modify this information without prior notification.

For any questions regarding assembly, please watch the video on the product page or contact our customer service. Our customer service will gladly assist you with any additional questions, comments, or concerns.

Thank you for using VIVOHOME products in your home!

Thank You for Purchasing from

VIVOHOME

Made in China

VIVOHOME

**HOW-TO**

**USER MANUAL**

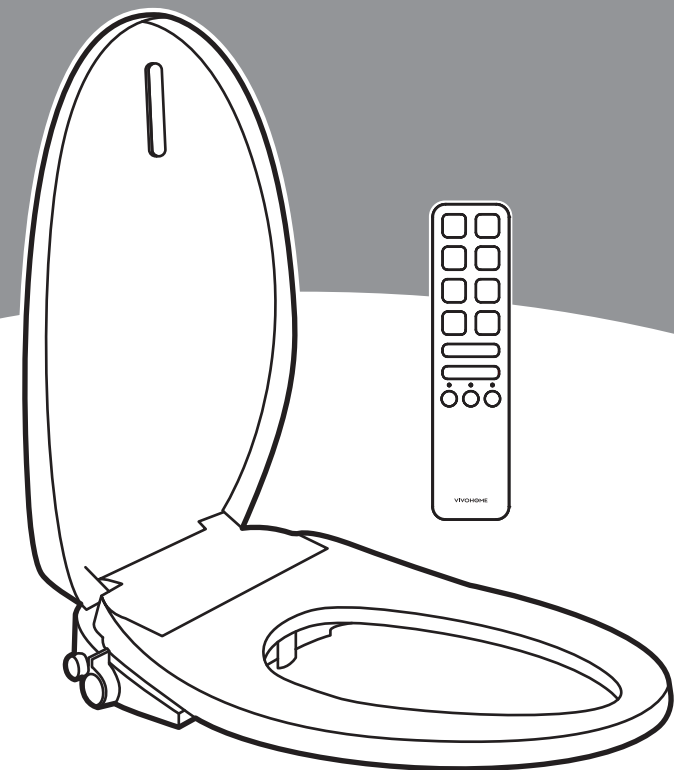

**Heated Bidet Seat  
With Remote**

Assembly is EASY!

**WE WANT  
YOU TO  
ENJOY LIFE  
AT HOME**

GO TO THE PRODUCT LISTING PAGE FOR  
AN INSTRUCTIONAL VIDEO!

## CONTENTS

Important Safeguards .....	1
Grounding Instructions .....	2
Safety Notes.....	3
Use Precautions.....	6
Component Description .....	7
Installation Steps.....	8
Installation and Pairing of Remote Control..	12
Product Description .....	14
Function Introduction.....	15
Instructions for Remote Control .....	17
Cleaning and Maintenance.....	18
Faults and Solutions.....	20
Product Dimension Drawing.....	22
Product Technical Specification.....	23
Warranty .....	25

## Important Safeguards



### Read all instructions before using

DANGER-To reduce risk of electrocution

1. Always unplug this product immediately after using it.
2. Do not use it while bathing.
3. Do not place or store product where it can fall or be pulled into a tub or sink.
4. Do not place in or drop into water or other liquids.
5. Do not reach for a product that has fallen into water. Unplug immediately.

### WARNING:

To reduce the risk of burns, electrocution, fire, or injury.

1. A product should never be left unattended when plugged in.
2. Close supervision is necessary when this product is used by, on, or near children or invalids.
3. Use this product only for its intended use as described in this manual. Do not use attachments that are not recommended by the manufacturer.
4. Never operate this product if it has a damaged cord or plug, if it is not working properly, if it has been dropped or damaged, or dropped into water. Return the product to a service center for examination and repair.
5. Keep the cord away from heated surfaces.
6. Never block the air openings of the product or place it on a soft surface, such as a bed or couch, where the air openings may be blocked. Keep the air openings free of lint, hair, and the like.
7. Never use it while sleeping or drowsy.
8. Never drop or insert any object into any opening or hose.
9. Do not use outdoors or operate where aerosol (spray) products are being used or where oxygen is being administered.

10. Connect this product to a properly grounded outlet only. See Grounding Instructions.
11. Unplug this product before filling. Fill (reservoir) with water only unless otherwise specified by manufacturer. Do not overfill (or specify filling instructions).

## SECTION B

## Grounding Instructions



This product should be connected to a grounded, metallic, permanent wiring system, or an equipment-grounding conductor should be run with the circuit conductors and connected to the equipment grounding terminal or lead on the product.

Cannot plug this power cord into an adapter. It must be plugged directly into a ground-fault circuit-interrupter (GFCI).

WARNING: Risk of electric shock - Connect only to a circuit that is protected by a ground-fault circuit-interrupter (GFCI).

### Grounding Methods

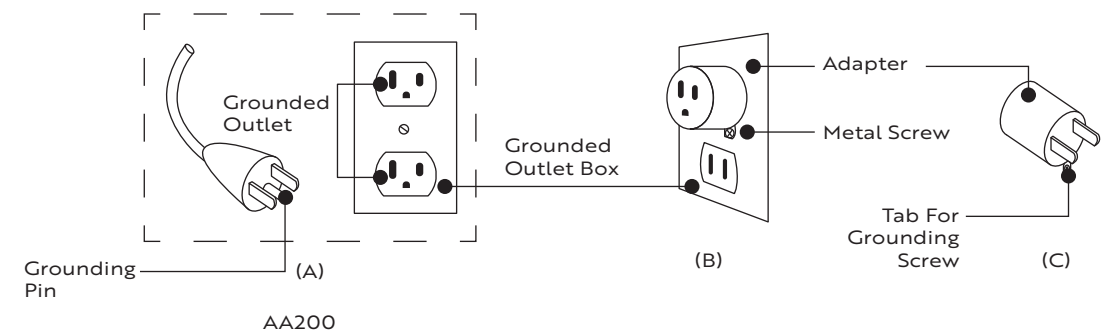



Read the safety instructions carefully before use so as to properly use the product.  
Note the following warnings relevant to the safety.



Warning



Prohibition

Compulsory  
observance

Note

Failure to operate pursuant to the above-mentioned warning signs may result in injury or a life-threatening risk.

This product is not suitable for use by individuals who have physical, sensory, or mental impairments, or lack experience, such as children due to their limited understanding or absence of necessary knowledge. It is essential that these individuals only operate the device under the supervision and guidance of someone responsible for their safety.



Avoid water splashing on the product.

- May result in fire or electric shock.

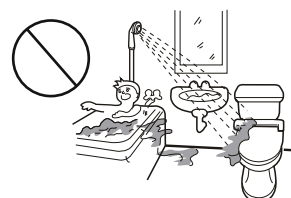

Earthing

Check if the 3-pole grounding structure is grounded.

- 3-pole grounding structure must be grounded, otherwise the product failure or electricity leakage will occur.



## Compulsory observance

The power cord of this product is a Y-type connection. If the power cord is damaged, it must be replaced by the manufacturer or technicians to avoid danger.

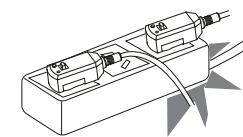

Do not plug this directly into an adapter of any kind.

- May result in overheating or fire.

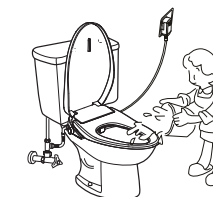

Ensure that the water, cleaning agent or urine does not wet the power plug.

- May result in fire or electric shock.



Do not pull the power plug/power cord at will.

- May result in fire or electric shock.

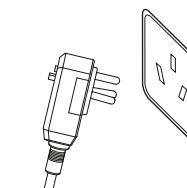

Do not use a loose socket.

- May result in fire or electric shock.

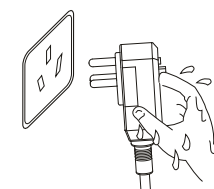

Do not plug/pull the power plug when the hand is wet.

- May result in electric shock.

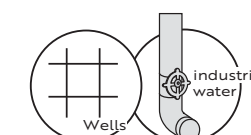

Do not connect to the substandard water pipe.

- May result in skin infections or product damage.



Do not disassemble, repair and modify products without authorization.

- May result in fire or electric shock.



Please unplug the power supply when cleaning the product.

- May result in electric shock.



Please don't keep the lighted cigarette or other combustion items near the product

- May result in fire.

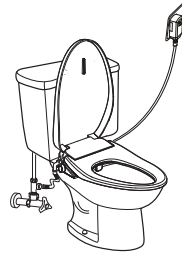

Do not bend or twist the water supply hose.

- May result in water leakage.

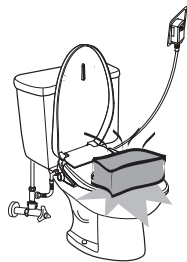

Do not place heavy objects on the toilet seat or the toilet cover

- May result product damage.



Do not invert product.

- May result in product damage.



Please clean with the diluted kitchen cleaning agent and do not use the following items. Benzene, paint thinner, detergent powder, nylon brush, etc.

- May result in product damage.

## SECTION D

# Use Precautions

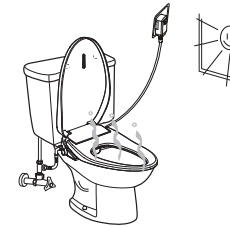

Do not place this product in direct sunlight.

- It may cause product discoloration and failure of seat heating function.



The room temperature of toilet shall be above 0°C.

- Otherwise, it is possible to freeze the product. Use warm air and other methods to improve the temperature in the toilet.



Do not shower urine on the bidet body and nozzle.

- May result in blockage.

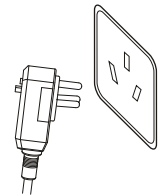

Please do not use substandard power supply.

- May cause product failure.

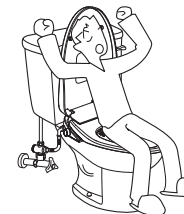

Do not lean against the tiltlid when in use

- May cause damage to the toilet lid.

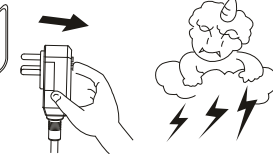

Pull off the power plug when lightning strikes.

- May result in product failure or damage.



When not in use for a long time, drain the stored water and pull the plug.

- Otherwise, water pollution and skin infections may be caused.



## 1. Cover plate

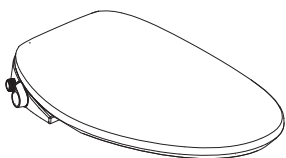

## 2. Installation template

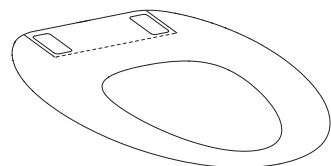

## 3. Fixation part



bolt (2)



sheet (2)

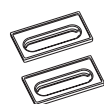

Plastic TAB(2)

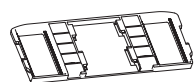

Fixing plate

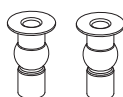

Rubber bushing(2)

Butterfly nut(2)  
Lock from bottom

## 4. T-junction

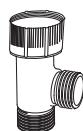
the picture is for  
indication

## 5. Water inlet hose



Filter screen

## 6. User manual

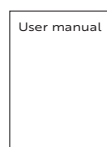

## 7. Remote control



## 8. Wrench(M16)



## Installation tools



Cross screwdriver



Monkey wrench



Barrel and rag

## Attention before installation

1. Water pressure range: 0.1-0.75 MPa, please follow the instructions.
2. Corner valves shall be located close to the location where this product is installed and disassembled.
3. Please use the braided hose that comes with the product to prevent water leakage.
4. When installing braided hose, be careful to prevent the black gasket from falling out.
5. Please install the check valve filter as shown in the right figure. When the one-way valve filter is ejected, the knob must be opened and replaced according to the direction shown in the figure.

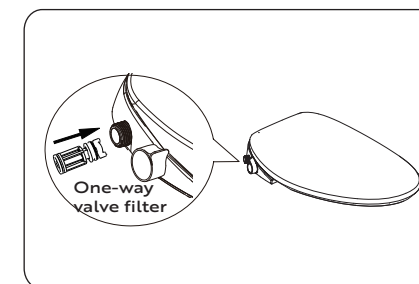

## Installation Procedure

1. Loosen the nut connecting and remove the old cover.
2. Place the mounting template on the ceramic as shown. Align it with the rim of the toilet.

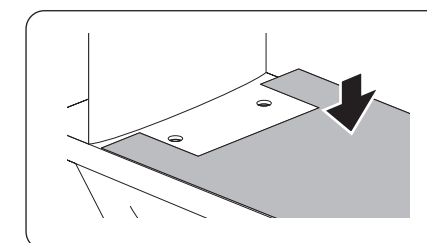

### 3.1

- Insert the expansion bolt into ceramic hole;
- Place fixing plate in notch part of template;
- Place adjusting sheet and plate in fixing plate;
- Align expansion bolt hole, and tighten up;

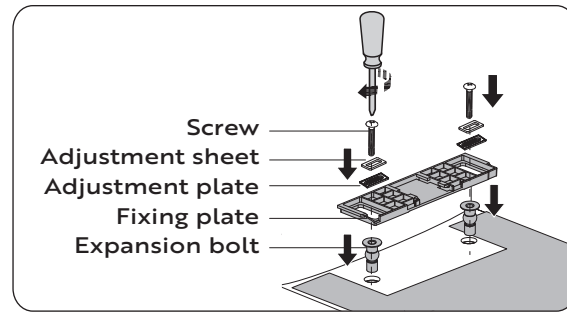

### 3.2

Lock-down installation is also available.

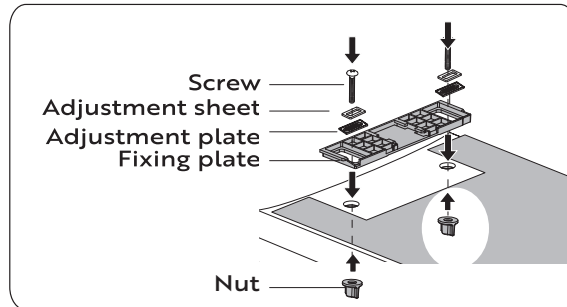

4. To ensure the normal use of the product, please press the reset key before installation;

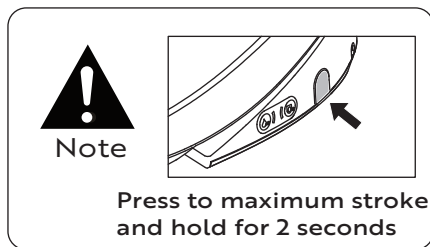

5. Slightly push the cover into the fixing plate until you hear "click", indicating that the cover has been installed in place.

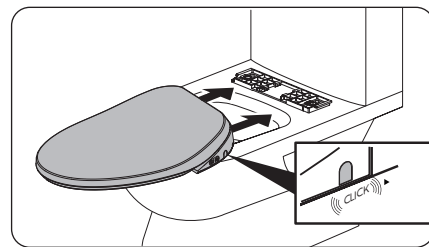

6. Close the water valve;

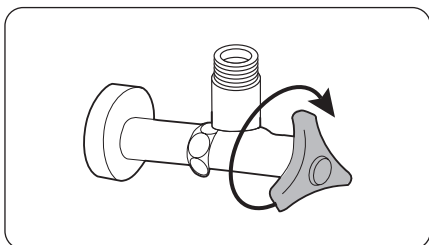

7. Install braided hose;

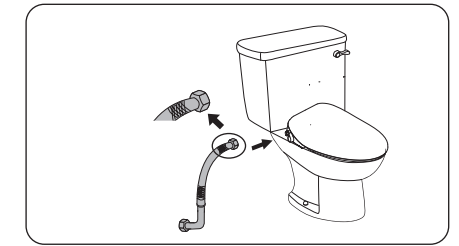
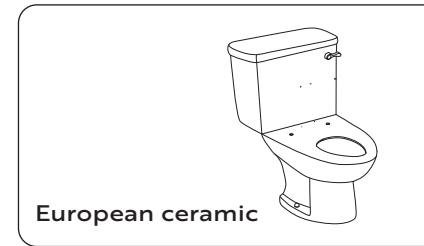

- When the ceramic is similar to the figure above, we suggest connecting the straight end of the hose to the cover.

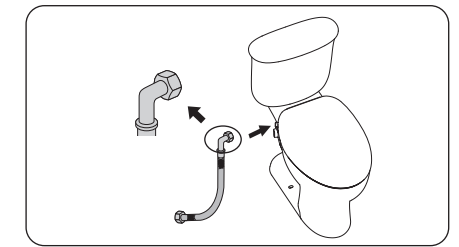
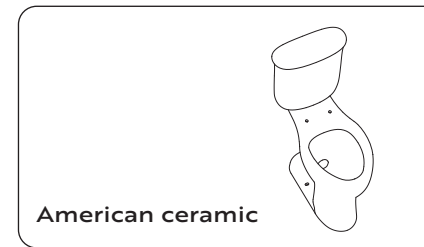

- When the ceramic is similar to the figure above, we suggest connecting the elbow end of the hose to the cover.

8. Installation tee;

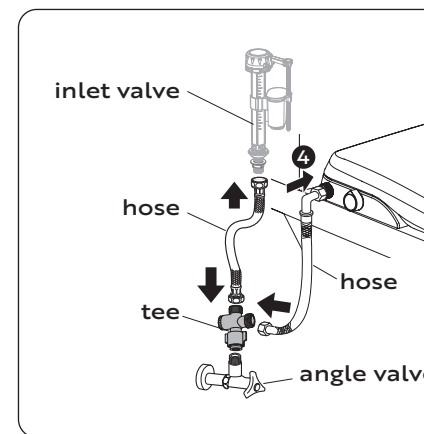

Normally, the tee is installed on the angle valve

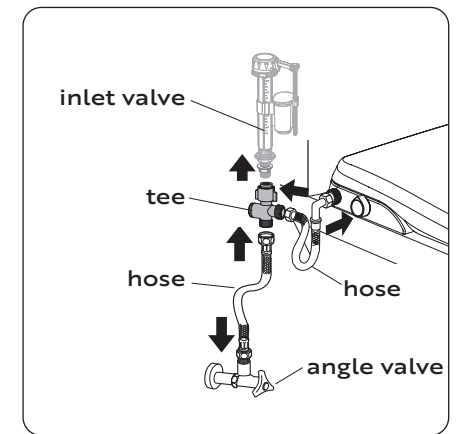

If the angle valve and wall are too close, you can install the tee under the inlet valve.

9. Open the angle valve to check for water leakage;

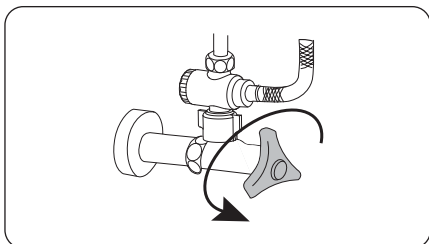

10. Turn on the knob to check whether the nozzle is protruding;

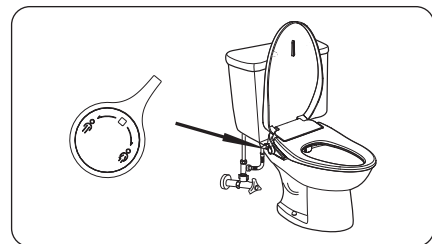

11. Plugged into a power supply;

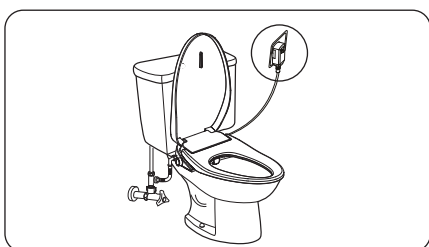

**Note**

In order to protect the internal circuit, be sure to turn on the knob to turn the nozzle out before plugging it into power.



**Prohibition**

1. It is strictly prohibited to move the product from the toilet cover; otherwise, it is easy to cause mechanical failure.
2. It is strictly prohibited to connect hot water above 40°C with cold water that may lead to icing.

**SECTION G**

**Installation and Pairing of Remote Control**



**1. Remote control installation**

Installation location: The figure shows the recommended installation location for the remote control. The installation location can be selected according to the actual use at home.

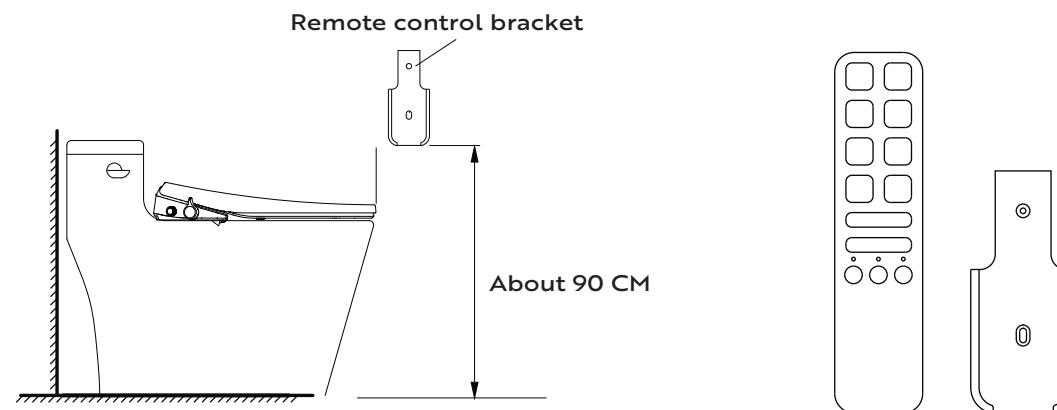

Installation steps:

1. Drill two holes with a diameter of 6mm on the wall with a depth of more than 45mm. The distance between two holes is the same as the distance between the installation holes of the remote control.
2. Insert the two expansion pipes in the accessory package into the two holes on the wall respectively.
3. Tear open the other side of double-sided adhesive tape, paste the remote control bracket on the wall, and pay attention to aligning the opening hole of the remote control with the hole on the wall.
4. Fix the remote control bracket with two screws in the accessories package.
5. Open the remote control battery cover, put the batteries in and put back the battery cover.
6. Place the remote control on the bracket.

## 2. Match remote control

After the battery is loaded into the remote control, it can be used normally.

If the product has no action, the remote control can be repaired in the following ways:

1. Disconnect the power supply.
2. Press the stop button on the remote control until the gear light flashes.
3. Put the remote control close to the flush button, and then turn on the power.
4. The gear light stops flashing when the match is successful.

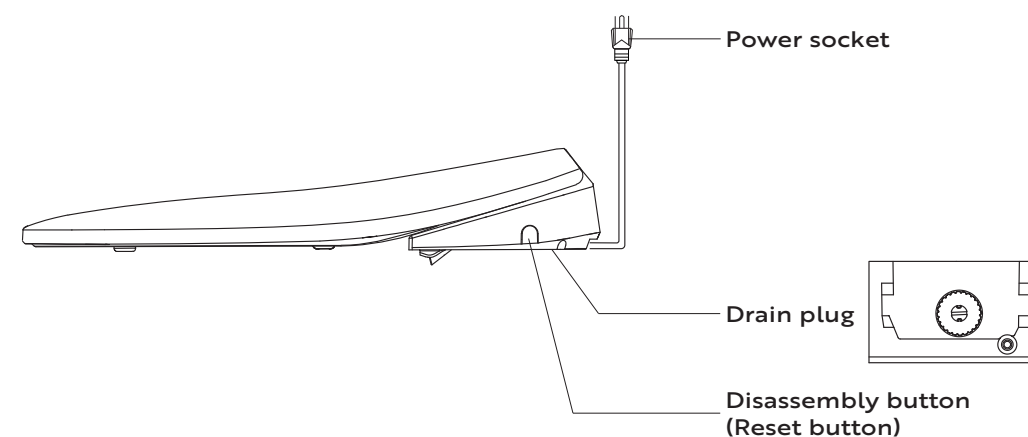
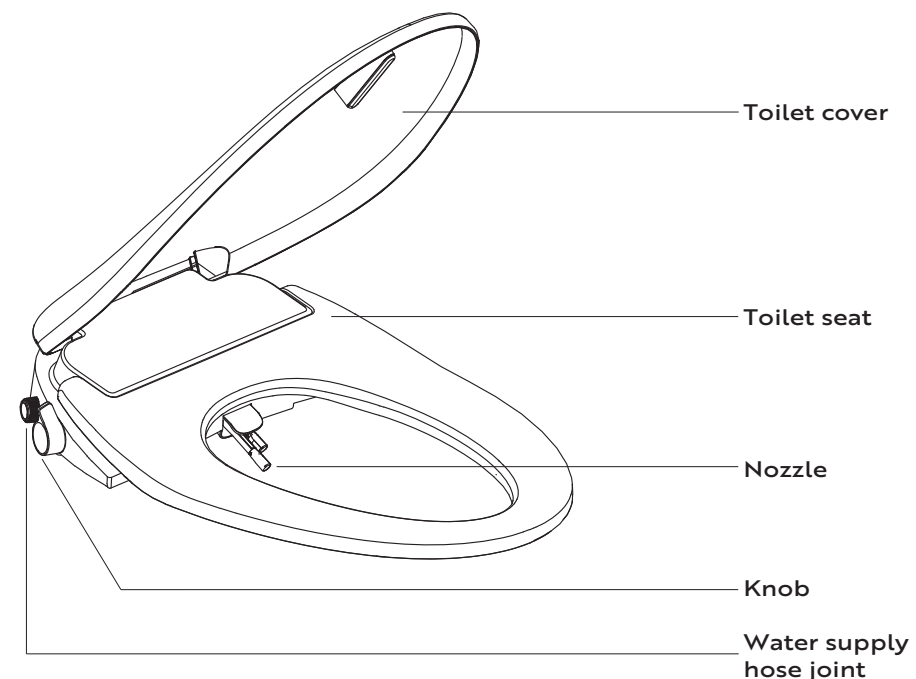
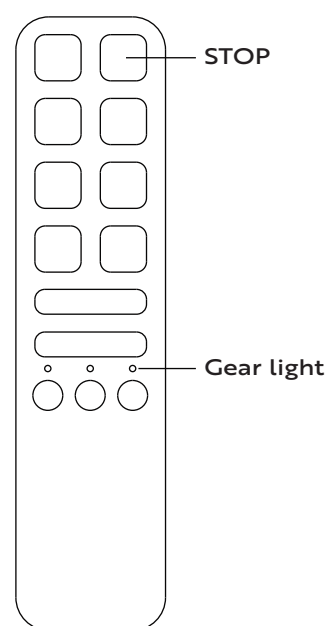



## Standby mode

1. After the power supply is connected, the "bi" indicates that the cover can be used normally.
2. Water temperature by default at low gear: about 35°C.
3. Seat temperature by default at low gear: about 33°C.

## Rinsing function

1. Bidet/Hip Rinsing

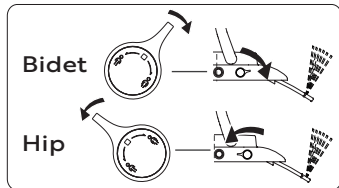

After sitting down, there is a beep prompt, rotating the knob to start rinsing

2. Self-cleaning

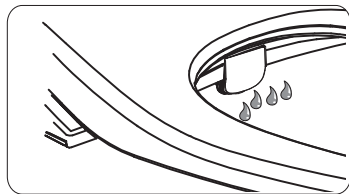

After sitting down, rotating the knob, spray rod self-cleaning, for cleaning nozzle

**Attention: close the knob after cleaning!**

## Protection functions:

1. Anti-splash function:  
When the knob is not completely closed, it will alarm and automatically switch to self-cleaning.
2. Water temperature protection function  
(1)When the water temperature exceeds 43°C, it will automatically switch to self-cleaning.  
(2)At this time,it must be reconnected to the power supply to reset product.
3. Low temperature scalding protection function:  
After seated by 5min, the seat temp. will automatically switch to Low temp. scalding protection.

## Use during power failure

The water temperature and seat temperature cannot be adjusted when the power supply is cut off, but the rinsing with normal temperature can be used.



### Note

The specific functions shall be subject to the actual products.

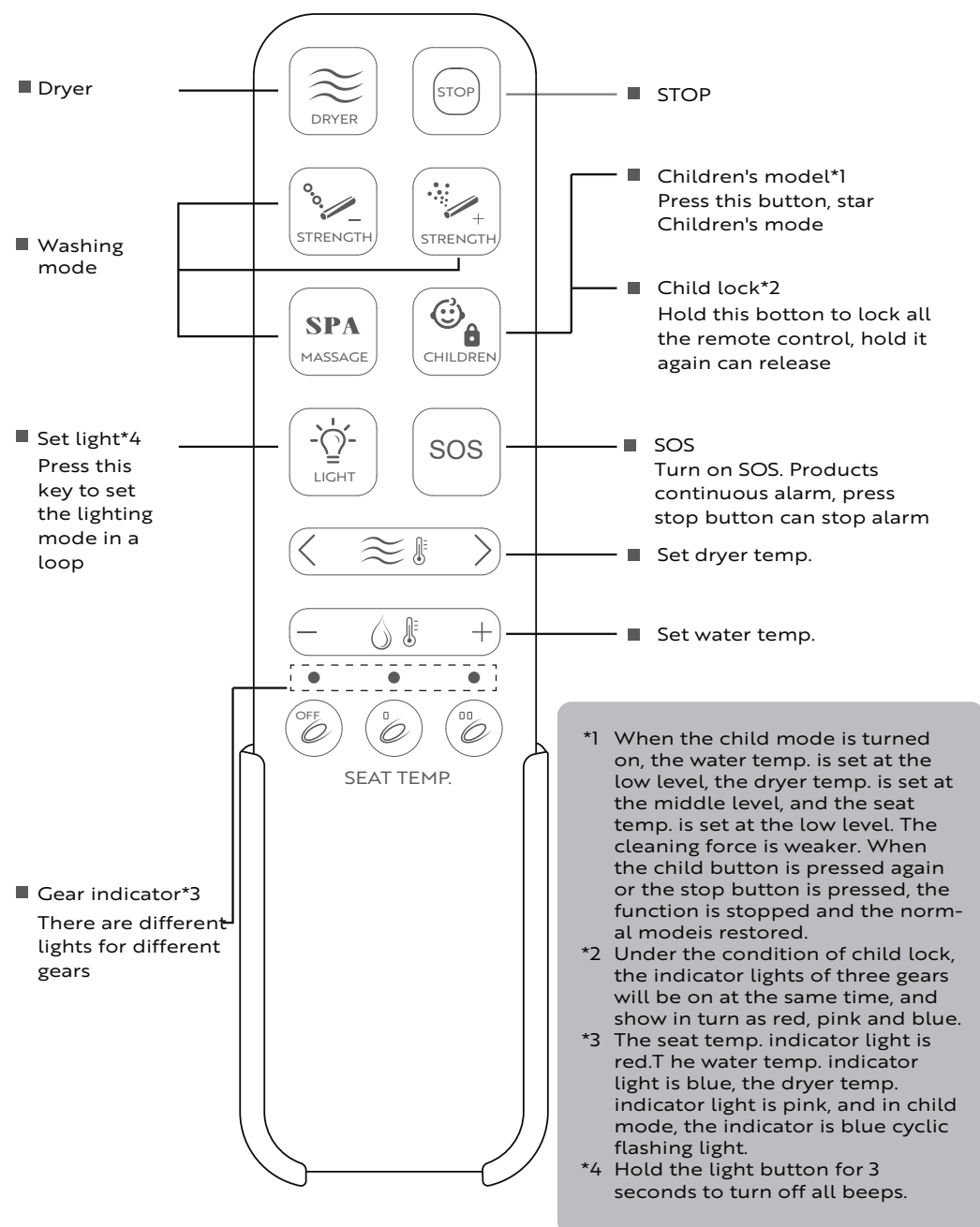

### Manual cleaning of spray tube

1. Gently pull out the nozzle and dip the neutral detergent with a soft cloth, sponge or small brush.
2. Gently support the nozzle, wipe the spray tube and nozzle.

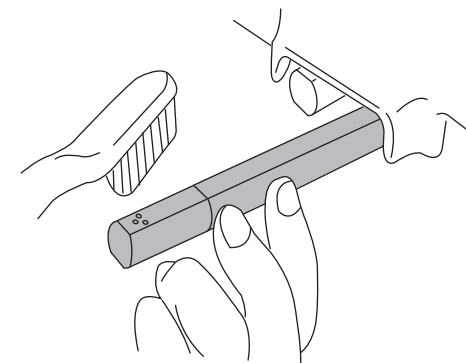

### Clean filter screen

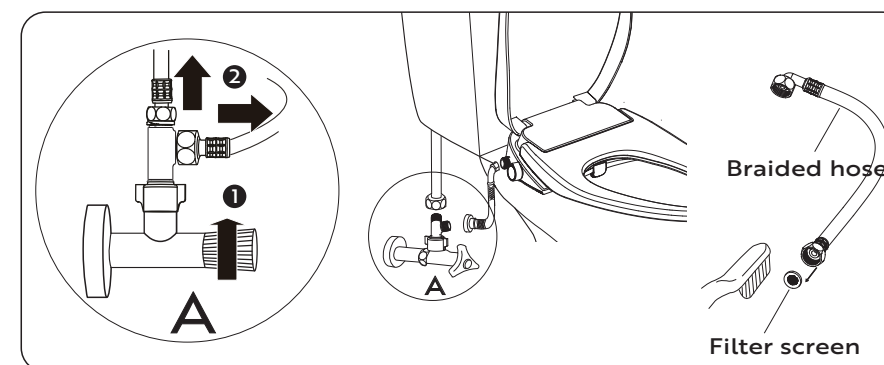

### TIPS:

1. Make sure that the corner valve is closed and the power is off before you clean the filter screen;
2. Clean the filter screen when the water flow is less than normal.
3. During the cleaning process, the product must be thoroughly separated from the water inlet hose;
4. Reinstall the filter screen in reverse order after cleaning.

## Product surface cleaning

 Note: Please cut off power supply before cleaning.

1. Wipe the product surface with a sponge or soft cloth dampened with room temperature water or a neutral detergent.
2. Lift the upper cover and the seat ring when cleaning other parts with cleaning agents.
3. Do not put a cover on before the cleaning agent in the ceramic toilet is completely washed; otherwise, the surface may be corroded by the evaporation of the cleaning agent.

## Product maintenance in winter

when the temperature of toilet below 0°C

1. Pull out the power plug.
2. Remove water inlet hose from the angle valve to the toilet end, and empty the water in the water inlet hose;
3. Remove the bottom nut, and drain the internal water.

## Not use in a long time

When this product is not used for a long time, drain the water in the product and cut off the power supply:

1. Pull out the power plug.
2. Close the angle valve and stop the water inlet.
3. Remove the water inlet hose from the angle valve to the toilet end, and empty the water in the water inlet hose.
4. Close the upper cover, press and hold the removal button by hand, move the electronic seat cover from the front, and then complete the removal.
5. Place the cover in a cool and dry place when not in use for a long time.



## Common fault diagnosis

When you think it is a fault, try some of the following processing methods. If the product is still not working properly, contact your local repair center or call the service hotline.

Check power supply	Check water supply
1.If power supply is under normal state. 2.Manual reset thermostat(Installation step4)	1.If water supply is under normal state. 2.If corner valve is closed.
If the following occurs, cut off the power supply immediately.	

 Note: When water leakage occurs, close the angle valve and cut off the power supply.

## Water leakage analysis

Phenomenon	Possible cause	Solution
When person leaves the seat, the product alarm and water outlet continues to leak	Knob is not close	Close the knob
	Control valve is failed	Cut off the power supply, close the angle valve and contact the after-sales department for replacement.

## Analysis of rising failure

Phenomenon	Possible cause	Solution
There is no water when the knob is turned on	The inlet hose folds, causing blockage	Close the Angle valve and reinstall the inlet hose
After turning on the knob, the spray rod does not extend, but continues to flow	Self-cleaning nozzle before rising	Wait a few seconds
	Didn't seat on interaction area	It is necessary to sit on the interaction area of theseat (there is a drip sound prompt), and then turn on the knob again
	Abnormal water temperature, product over-temperature protection	Pull out the power plug to reset and reconnect the power after 5 seconds,
	Abnormal temperature sensor. Water vapor enters the product during use or cleaning in an environment without dry/wet separation, resulting in temporary short circuit	Please leave the product in a dry environment for 1-2 days, and reconnect the electricity to restore normal use. If the fault is still there, please contact the after-sales service for maintenance or replacement.

Phenomenon	Possible cause	Solution
After turning on the knob, spray rod does not extend, a lot of water into the toilet	Abnormal pressure, product switch to pressure relief mode	Please close the Angle valve, remove the hose, check whether there is any foreign matter in the filter screen at the inlet of the product, reinstall the hose, open the Angle valve, and then open the knob to the maximum.
Normal water pressure, little cleaning water, cleaning force is weak	There are impurities in the water, use for a period of time, the filter screen blocked	Please clean the filter screen of the hose and the filter screen of the product inlet according to the maintenance instructions
Spray rod can be normally extended to rinsing but no warm water	The product is not connected to power supply	Plug the product into the power socket and check whether the indicator light of the leaky plug is on
	The water temperature function is turned off	Turn on the water temperature function by pressing the key
	The product over-temperature protector is disconnected, so reset operation is needed	Press the product disassembly button in the deepest place and hold it for two seconds (installation step 4)

### Failure analysis of seat

Phenomenon	Possible cause	Solution
The seat is cold	The seat heating is turned off	Turn on the heating function in advance
Temperature drops When rinsing	The product started the low temperature scald prevention function	After cleaning, the setting temperature will rise again

### Failure analysis of light

Phenomenon	Possible cause	Solution
Night light is not ON.	Night light is turned off or damaged	Reconnect to the power supply, if the fault still exists, contact the after-sales department for a replacement

### Failure analysis of warm wind

Phenomenon	Possible cause	Solution
No warm wind	Over temperature protection	Unplug the power plug 5 minutes apart and reconnect to the power supply. If the failure is still the same, please unplug the power supply, close the angle valve, and contact the after-sales service.

## SECTION M

# Product Dimension Drawing

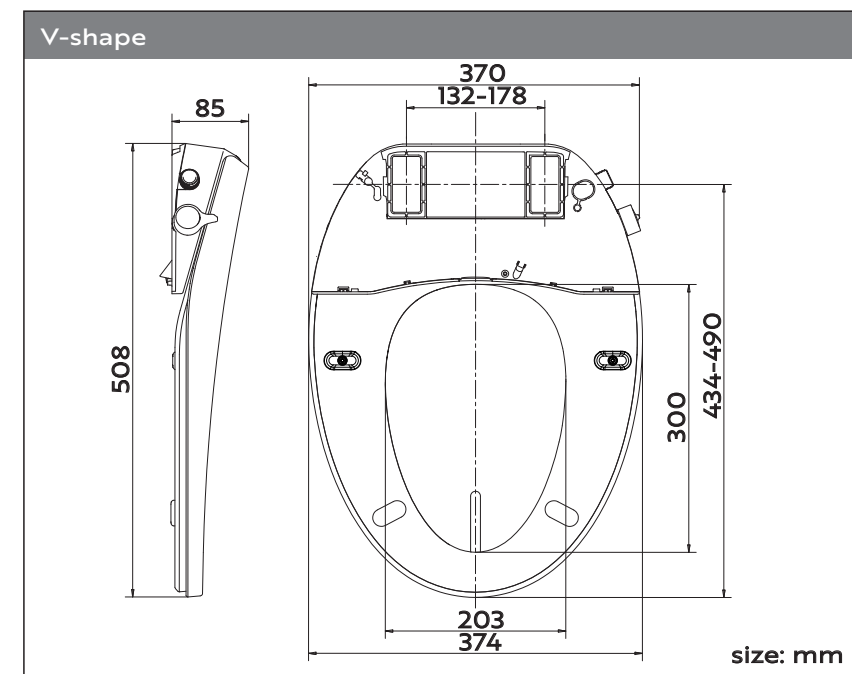



Items		Description
Rated voltage		120 V, 60 Hz
Rated power		1050 W
Length of power line		About 1.1m
Water supply pressure		0.1 ~ 0.75 MPa(Static pressure)
Water supply temperature		5 ~ 35°C
Ambient temperature		0 ~ 40°C
Water proof grade		IPX4
Cleaning device	Water amount regulation	Stepless regulation
	Water temperature regulation	Gear 3: about 35/38°C/OFF
	Heating method	Instant heating
	Protective device	Anti-siphon valve + anti-backflow valve
	Safety device	Double thermostat
Warm seat	Surface temperature	Gear 3: about 33/37°C/OFF
	Heater power	50 W
	Safety device	thermostat & fuse
Warm wind	wind temperature	Gear 3: about 33-43°C (The specific temp. is slightly different depending on the ambient temp.)
	Heating wire power	180 W
	Safety device	Thermostat + fuse
Others	Massage rinse	YES
	Antibacterial material	Nozzle and seat
	Low temperature scalding protection	YES
	Abnormality prompt	Alarm sound
	Control operation	Knob
	Auxiliary key	Water temperature and seat temperature setting
	Seat sense	YES
	Light control	YES

Rated power:

Under the ambient temp. of 23±2°C and the inlet water temp. of 15±1°C, the product starts to power up and start up, and the water temp. and setting temp. are adjusted to top grade. Turn on the hip wash function for testing (the reference flow rate is about 600ml/min). The measured product works continuously and stably. Average power of cleaning cycle (3 minutes)



The VIVOHOME warranty program is our commitment to you. We are committed to providing you with a high-quality product that meets your needs and expectations. To demonstrate our confidence in the durability and performance of our products, we offer the following warranty.

### WARRANTY COVERAGE

This warranty program applies to any orders, purchases, receipts, or use of any products sold by VIVOHOME and is valid for a period of 1 year from the date of purchase. However, please note that this warranty period is only valid for the original order. If you receive a replacement order during the warranty period, it will not include a separate warranty period.

### WARRANTY EXCLUSIONS

This warranty does not cover damage resulting from misuse, accident, unauthorized modification, or any other circumstances not directly related to the manufacturing and design of the product, including but not limited to:

- Parts lost during use.
- Normal wear and tear of products or parts.
- Incorrect installation (such as using the wrong voltage) or assembly.
- Exceeding the bearing capacity of the product.
- Use under extremely harsh conditions.



- Improper cleaning or maintenance.
- Damage caused by any reason other than the intended use of the product.
- Indirect loss or damage caused by the product.

### HOW TO MAKE A WARRANTY CLAIM

If you find any defects that affect the use of the product or if the product stops working and cannot be repaired during the warranty period, please contact our customer service team at our email or via Amazon & app's direct messaging service as soon as possible. Provide the following information to expedite the process:

- Order number
- Images and/or videos illustrating the issue
- A detailed description of the problem

VIVOHOME will provide technical support, replacement, refund, or other solutions based on the nature of the issue. If you wish to return the original package for any reason, please contact us for confirmation before proceeding. You can expect to receive a response within 48 hours.

Thank you for choosing VIVOHOME. We are committed to ensuring the quality and satisfaction of your purchase. If you have any questions or need assistance, please do not hesitate to contact our customer service team.

