

# INSTALLATION MANUAL

## CHANDELIER

Model No.: HLP312BL-18A

### TOOLS REQUIRED



Ladder

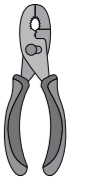

Pliers

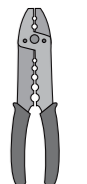

Wire  
Strippers

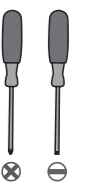

Screwdrivers



Power Drill

**Thank you for choosing and using our product.**

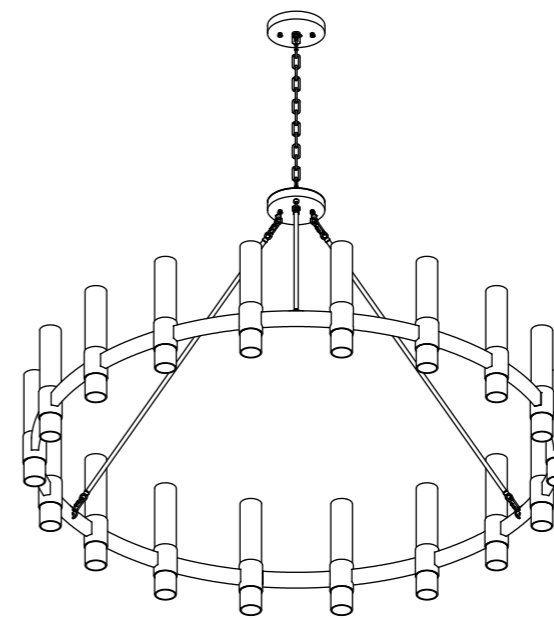

CHANDELIER with CHAIN-MOUNT

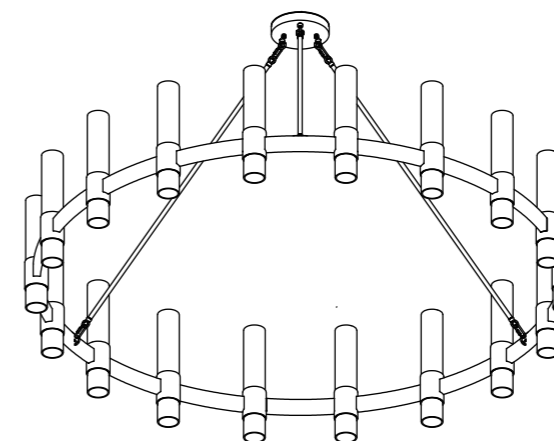





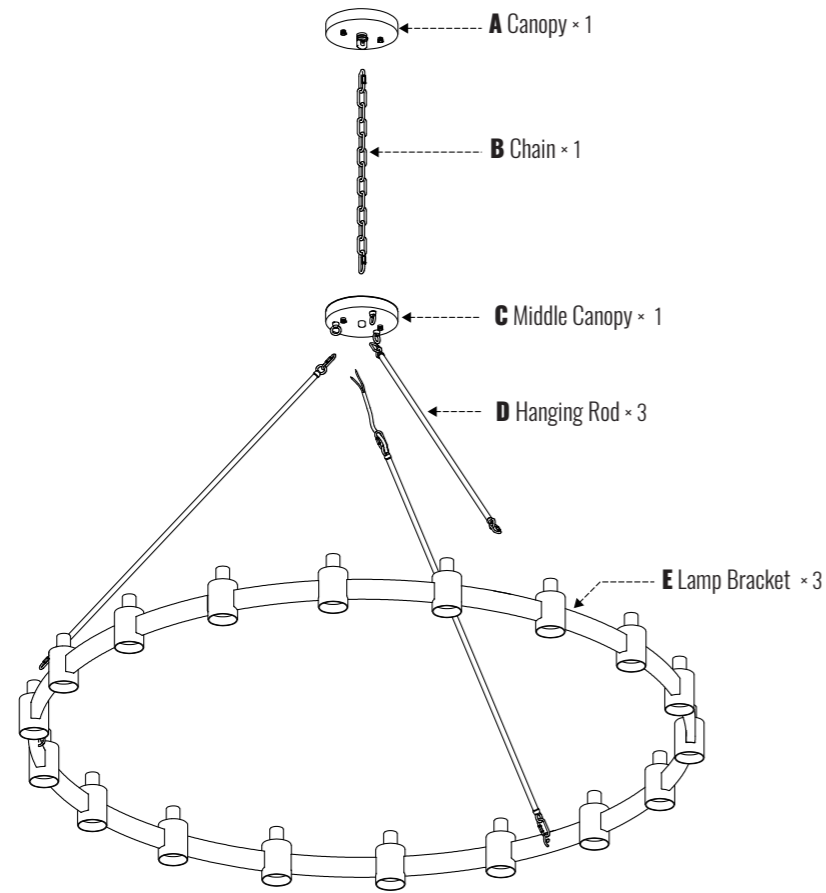



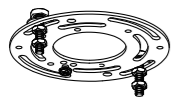

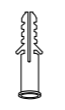

CHANDELIER with FLUSH-MOUNT

# PACKING LIST



# INSTALLATION KIT

<b>AA</b>  Mounting Bracket	2x	<b>BB</b>  Ground Screw	1x	<b>CC</b>  Wood Screw	4x	<b>DD</b>  Cap Nut	4x
<b>EE</b>  Wire Nut	3x	<b>FF</b>  Outlet Box Screw	2x	<b>GG</b>  Quick Link	8x	<b>HH</b>  Plastic Anchor	4x
<b>II</b>  Anchor Bolt	3x	<b>JJ</b>  Long Glass Shade	18x	<b>KK</b>  Short Glass Shade	18x	<b>LL</b>  Lamp Body Screw	6x
<b>MM</b>  Gloves							1x

### Note:

- Some extra hardware may be included. The quantity listed above is the number required for installation.
- There are two Mounting Brackets: one is pre-installed on Canopy (A), and the other is pre-installed on Middle Canopy (C).
- BB/DD are pre-installed on the Mounting Bracket (AA).
- GG is pre-installed on the Chain (B) and the Hanging Rod (D).
- LL is pre-installed on the Lamp Bracket (E).

# INSTALLATION (FOR CHAIN-MOUNT)

## 1.Assemble the Lamp Body

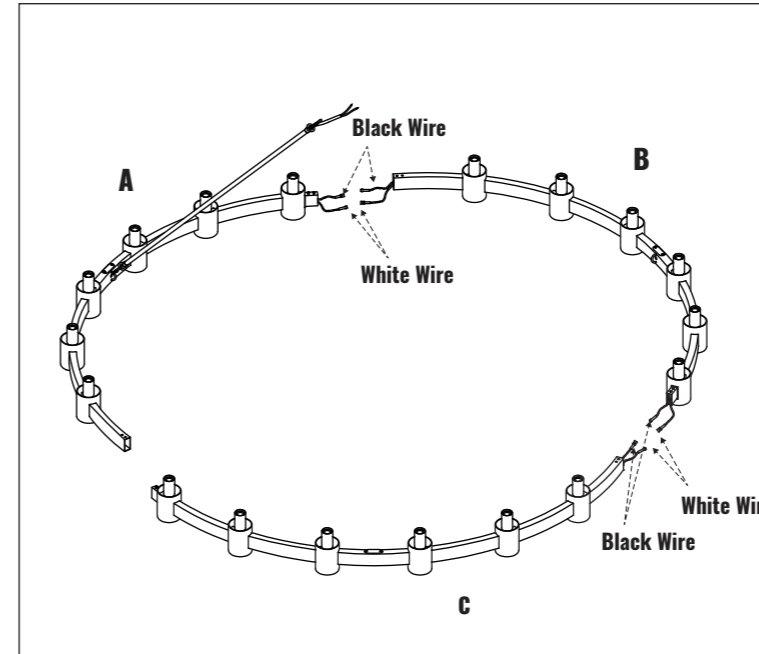

- STEP 1:** Arrange the Lamp Bracket (E) into circles in order A-B-C.  
**STEP 2:** Connect the black line to the black line and the white line to the white line.

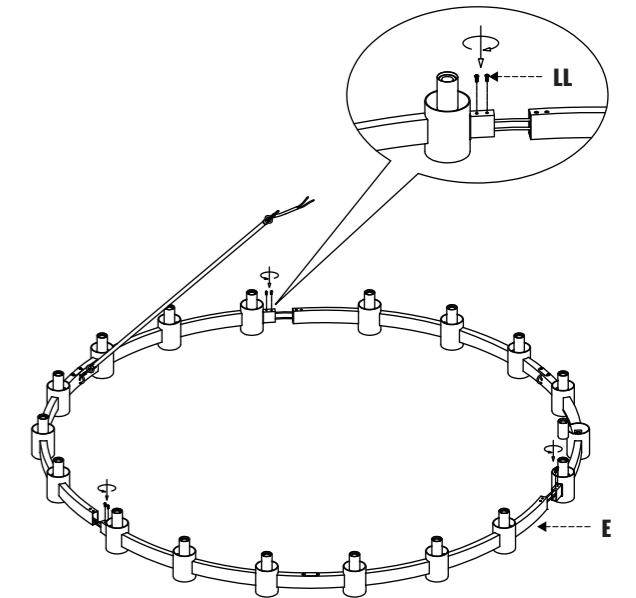

- STEP 3:** Loosen the Lamp Body Screw (LL) on the Lamp Bracket (E) and insert the connected wires into the Lamp Bracket (E).

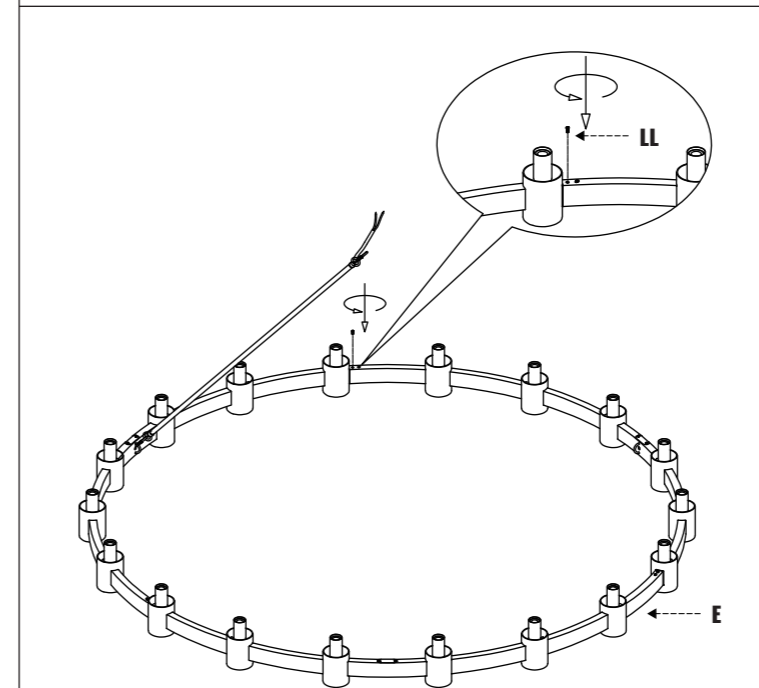

- STEP 4:** Align the round holes in the Lamp Bracket (E) and tighten the Lamp Body Screw (LL).

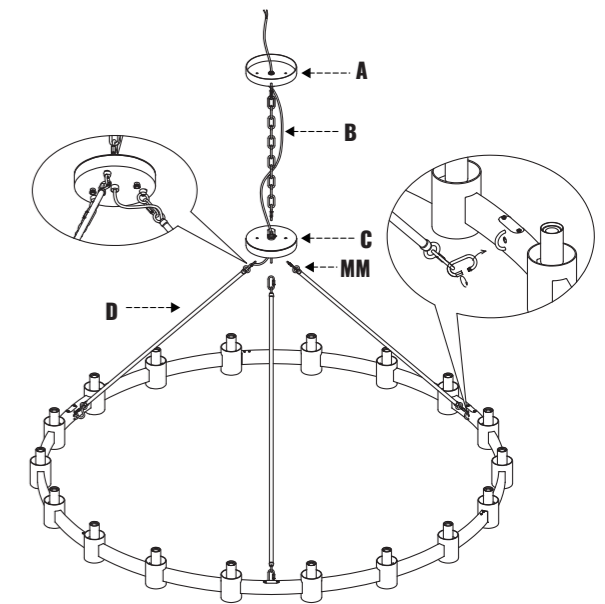

- STEP 5:** Pass the power cord of the Hanging Rod (D) through the Middle Canopy (C), Chain (B), and Canopy (A) in turn.  
**STEP 6:** Open the Quick Link (GG) on the Hanging Rod (D), then connect it on both ends of Hanging Rod (D) to the Middle Canopy (C) and the loop of the Lamp Bracket (E), and finally lock it tightly.  
**STEP 7:** Open the Quick Link (GG) on the Chain (B), then connect it on both ends of Chain (B) to the Canopy (A) and the fixture loop of the Middle Canopy (C), and finally lock the it tightly.

## 2. Install the Mounting Bracket

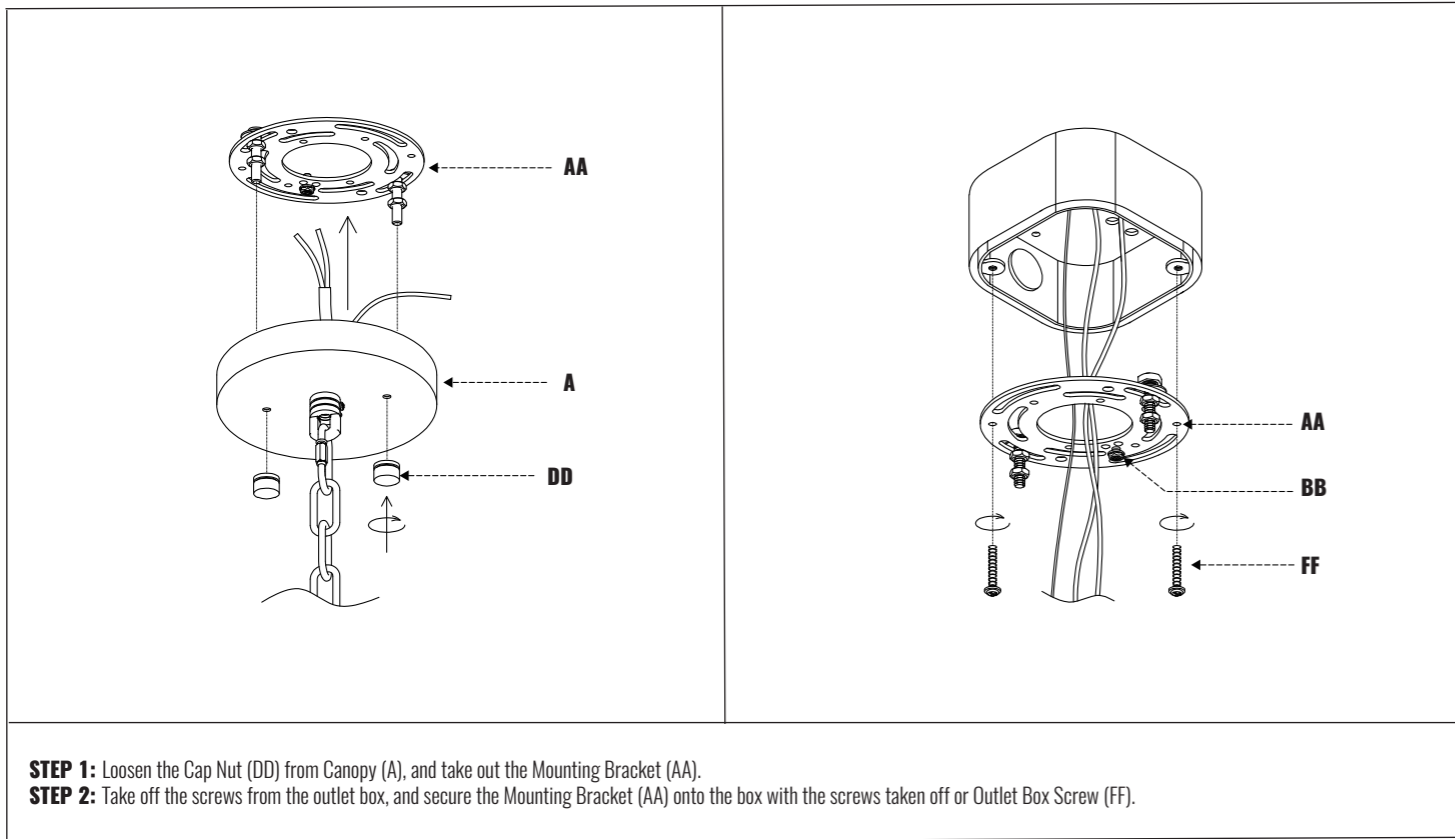

## 3. Connect the Wires

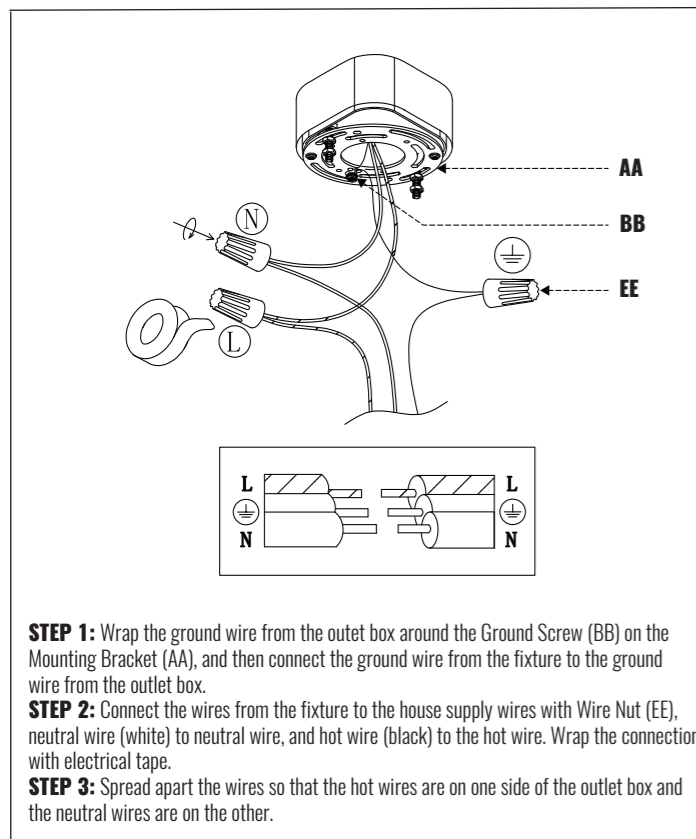

## 4. Fix the Canopy

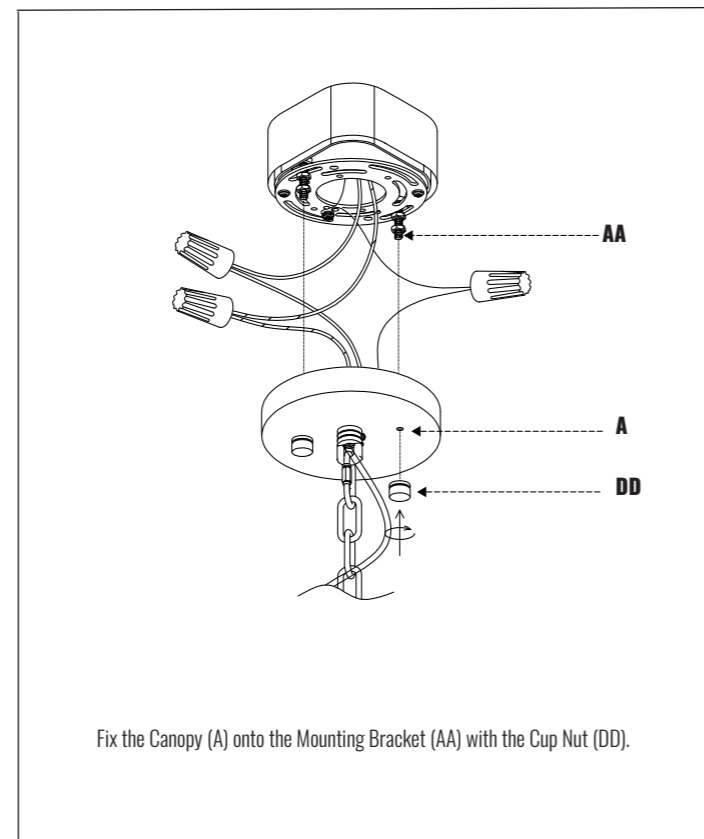

## INSTALLATION (FOR FLUSH-MOUNT)

### 1. Assemble the Lamp Body

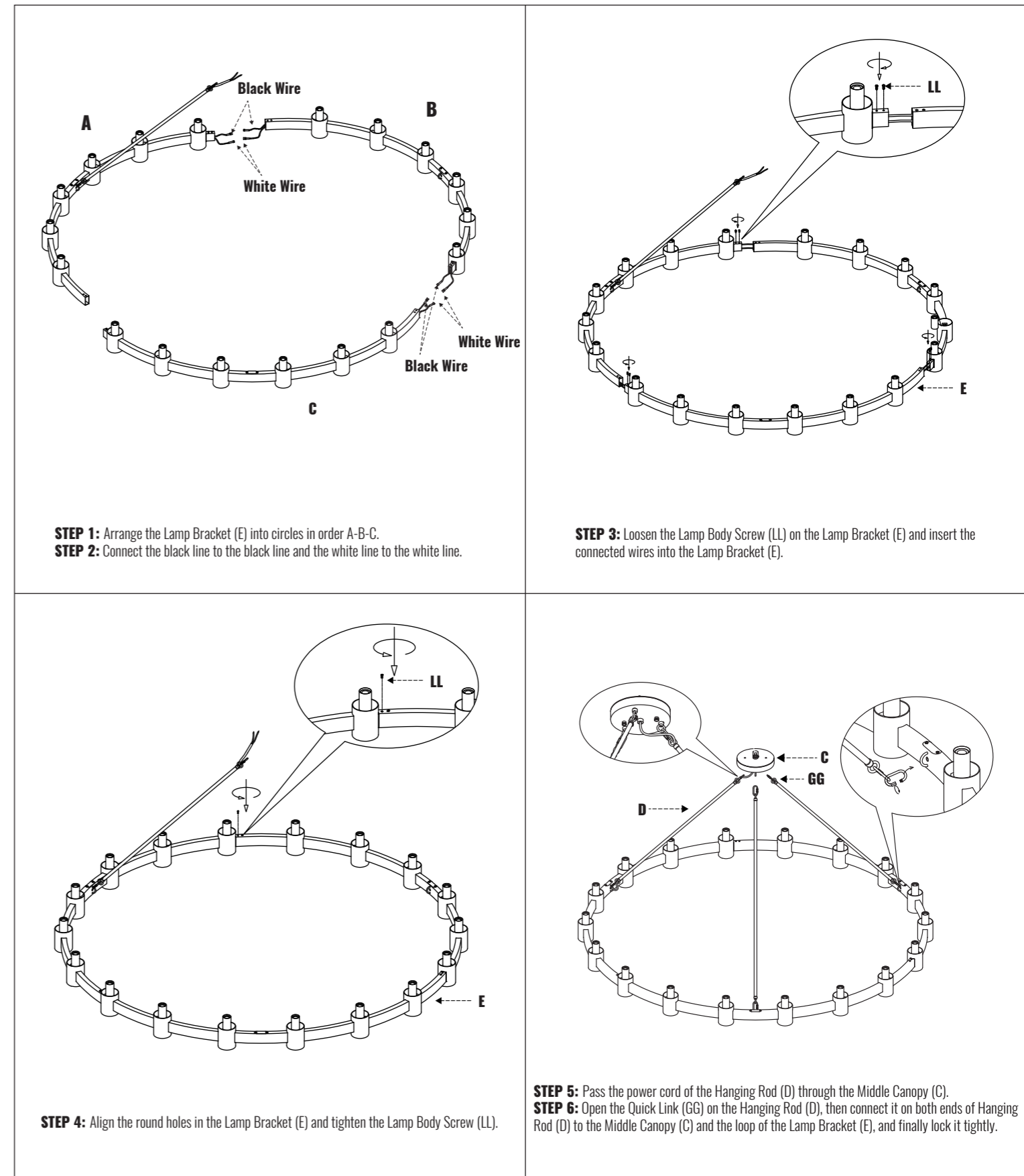

## 2. Install the Mounting Bracket

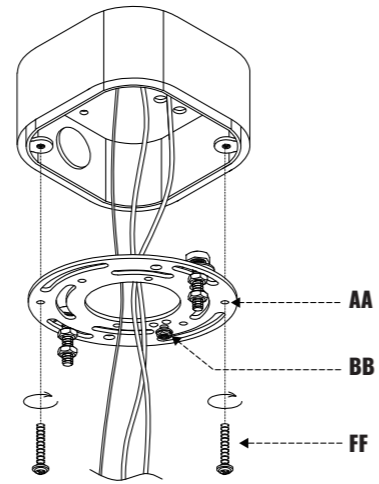
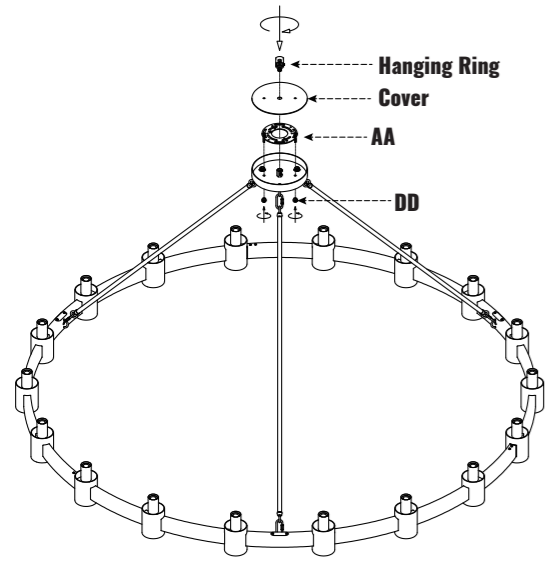

**STEP 1:** Unscrew the Hanging Ring and remove the Cover.

**STEP 2:** Loosen the Cap Nut (DD) from Middle Canopy (C), and take out the Mounting Bracket (AA).

**STEP 3:** Take off the screws from the outlet box, and secure the Mounting Bracket (AA) onto the box with the screws taken off or Outlet Box Screw (FF).

## 3. Connect the Wires

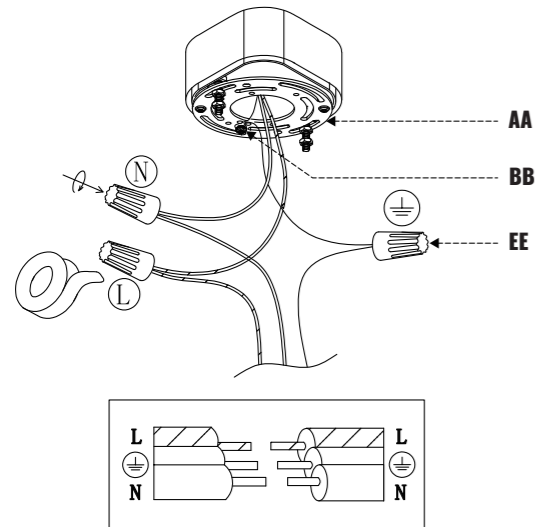

**STEP 1:** Wrap the ground wire from the outlet box around the Ground Screw (BB) on the Mounting Bracket (AA), and then connect the ground wire from the fixture to the ground wire from the outlet box.

**STEP 2:** Connect the wires from the fixture to the house supply wires with Wire Nut (EE), neutral wire (white) to neutral wire, and hot wire (black) to the hot wire. Wrap the connection with electrical tape.

**STEP 3:** Spread apart the wires so that the hot wires are on one side of the outlet box and the neutral wires are on the other.

## 4. Fix the Canopy

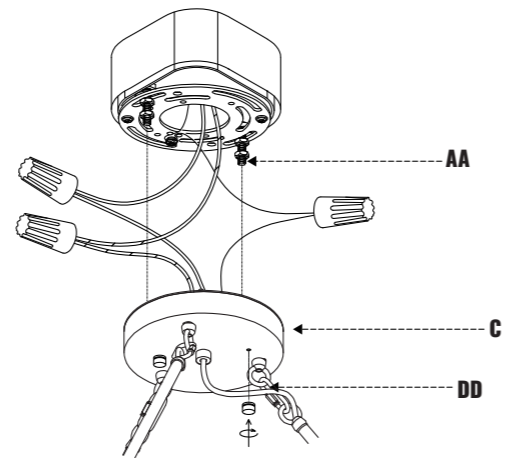

Fix the Middle Canopy (C) onto the Mounting Bracket (AA) with the Cup Nut (DD).

## BULB AND LAMPSHADE INSTALLATION

### 1. Install the Bulbs

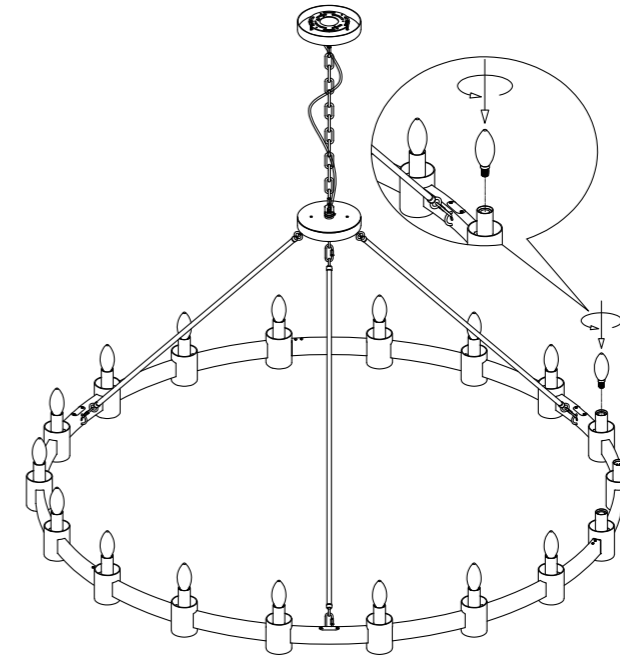

E12 x 18, Max 40W each, LED recommended (not included).

Note:

To achieve dimming functionality, you need to use dimmable bulbs and a dimmer switch.

### 2. Install the Glass Shade

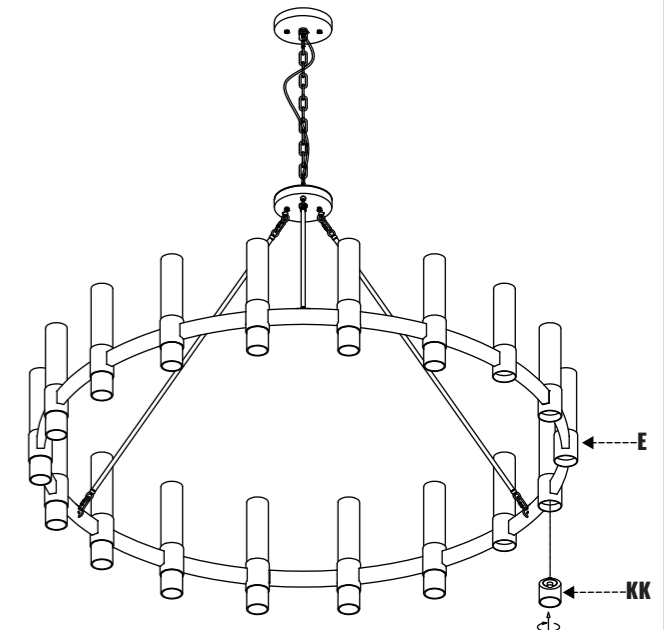
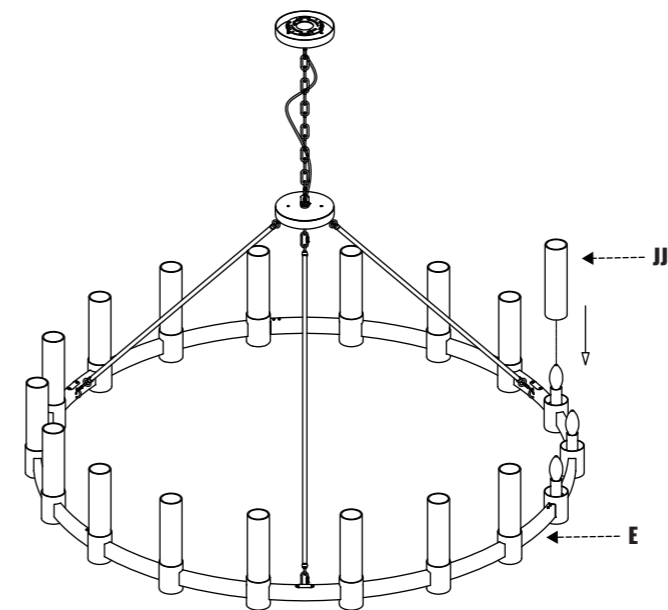

**STEP 1:** Place the Long Glass Shade (JJ) over the Lamp Bracket (E).

**STEP 2:** Twist the Short Glass Shade (KK) into the bottom of the Lamp Bracket (E).