

ASSEMBLY INSTRUCTIONS

52015 KING BED

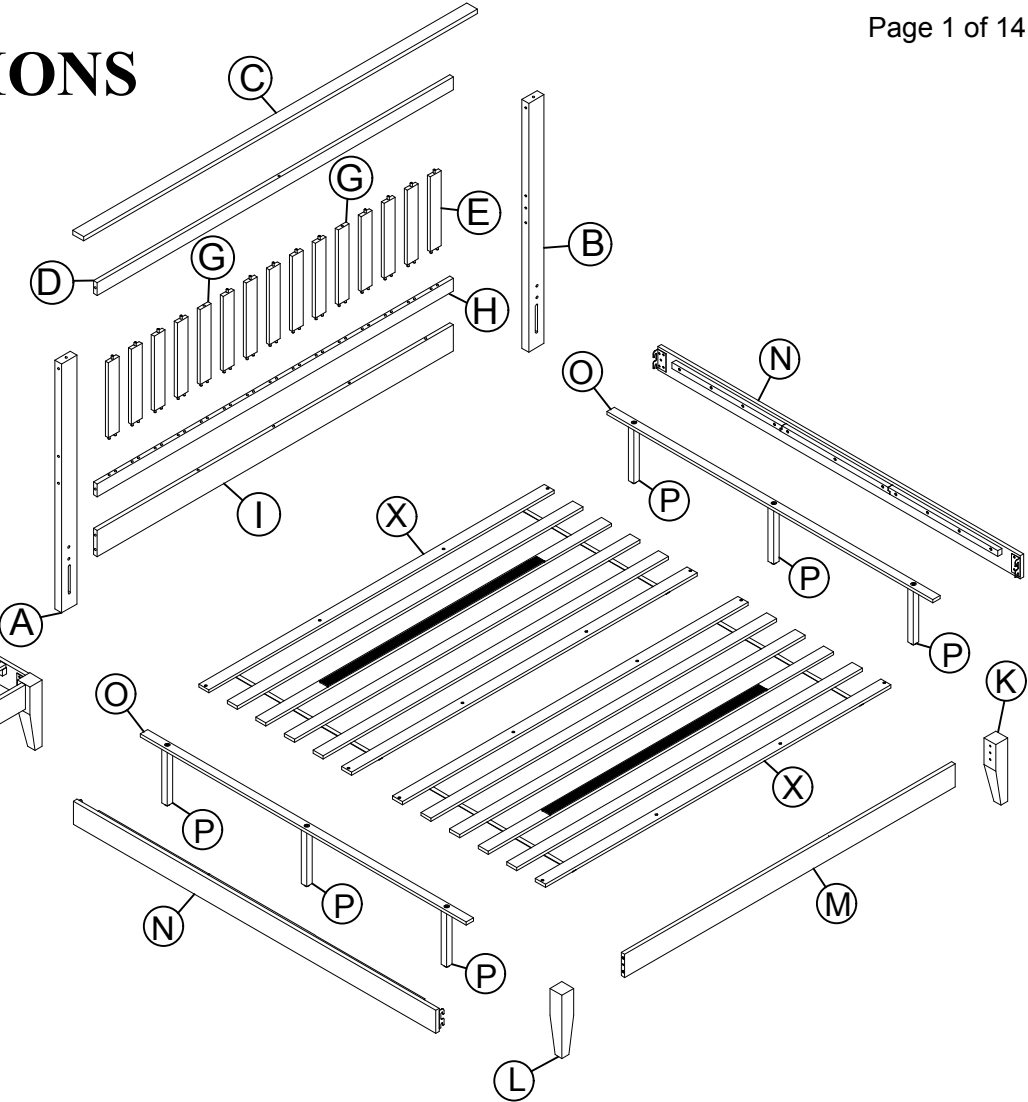
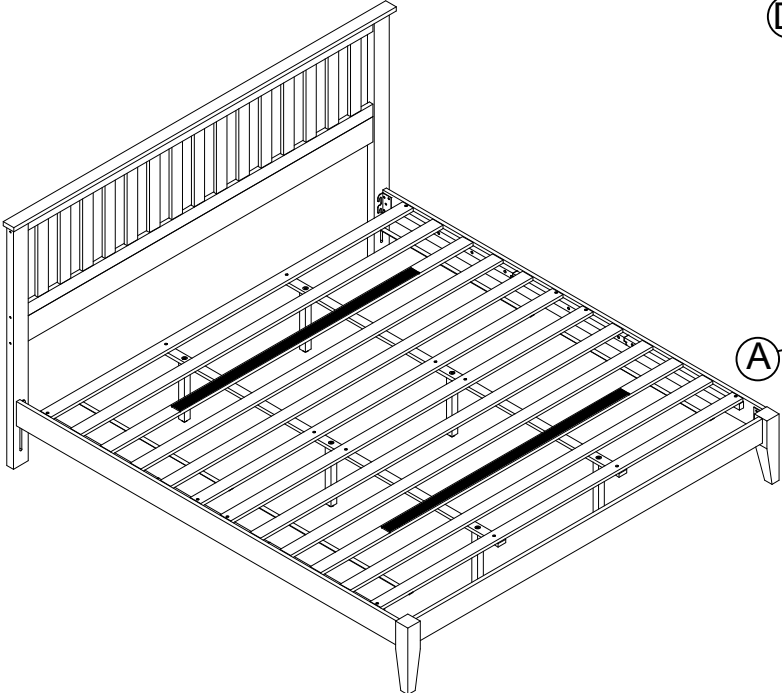

52015 KING BED

ASSEMBLY INSTRUCTIONS

Read these instructions carefully and keep for future reference. Refer to parts inventory for guidance, and ensure you have all pieces before starting.

When assembling, place all parts on a soft, clean, and flat surface such as a carpet to prevent scratches.

If you're having difficulty, our friendly Customer Care team is always here to help. Call us at 1.336.861.0604 during business hours, email parts@comfortpointe.com.

Attention : Veuillez Lire Toutes Les Instructions Avant De Commencer L'assemblage De Ce Produit. Les Pièces Sont Lourdes. Pour Éviter Toute Blessure Et Pour Vous Assurer Que Le Produit N'est Pas Endommagé Pendant L'assemblage, Nous Vous Recommandons De Faire Appel À Une Ou Plusieurs Autres Personnes.

Cuidado: Favor De Leer Todas Las Instrucciones Antes De Ensamblar Su Producto. Estas Piezas Son Pesadas. Para Prevenir Heridas Personales Y Asegurar Que Su Producto No Sea Dañado Mientras Es Ensamblado, Se Recomienda La Asistencia De Una O Más Personas.



TIME



OF PEOPLE

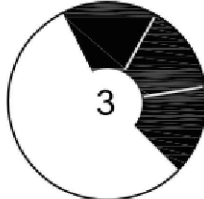









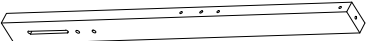

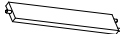

DIFFICULTY

Important: Use hand tools for assembly. Power tools can lead to over-tightening and damage.

52015 KING BED





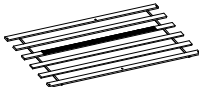







Parts List

CODE	DESCRIPTION	QTY
A	Left headboard leg 	1PC
B	Right headboard leg 	1PC
C	Headboard Top 	1PC
D	Crossbar Top 	1PC
E	Vertical slats 	13PCS
G	Vertical slats with camlock 	2PCS
H	Crossbar 	1PC
I	Crossbar Bottom 	1PC

CODE	DESCRIPTION	QTY
K	Right footboard leg 	1PC
L	Left footboard leg 	1PC
M	Footboard 	1PC
N	Side Rail 	2PCS
O	Middle Cross Slats 	2PCS
P	Support legs 	6PCS
X	Slats 	2rolls

52015 KING BED

Hardware List

CODE	DESCRIPTION	QTY	CODE	DESCRIPTION	QTY
1 . Bolt 5/16"x20mm		8PCS	8 . Flat Head Screwdriver		1PC
2 . Spring Washer		8PCS	9 . Allen key		1PC
3 . Flat Washer		8PCS	10 . Curved Washer		2PCS
4 . Cam lock Bolt M6x40mm		16PCS	11 . Nut		2PCS
5 . Cam lock Ø15mm		16PCS	12 . Bolt		2PCS
6 . Dowel 8x30mm		8PCS	13 . Wrench		1PC
7 . screws		16PCS			

1

52015 KING BED

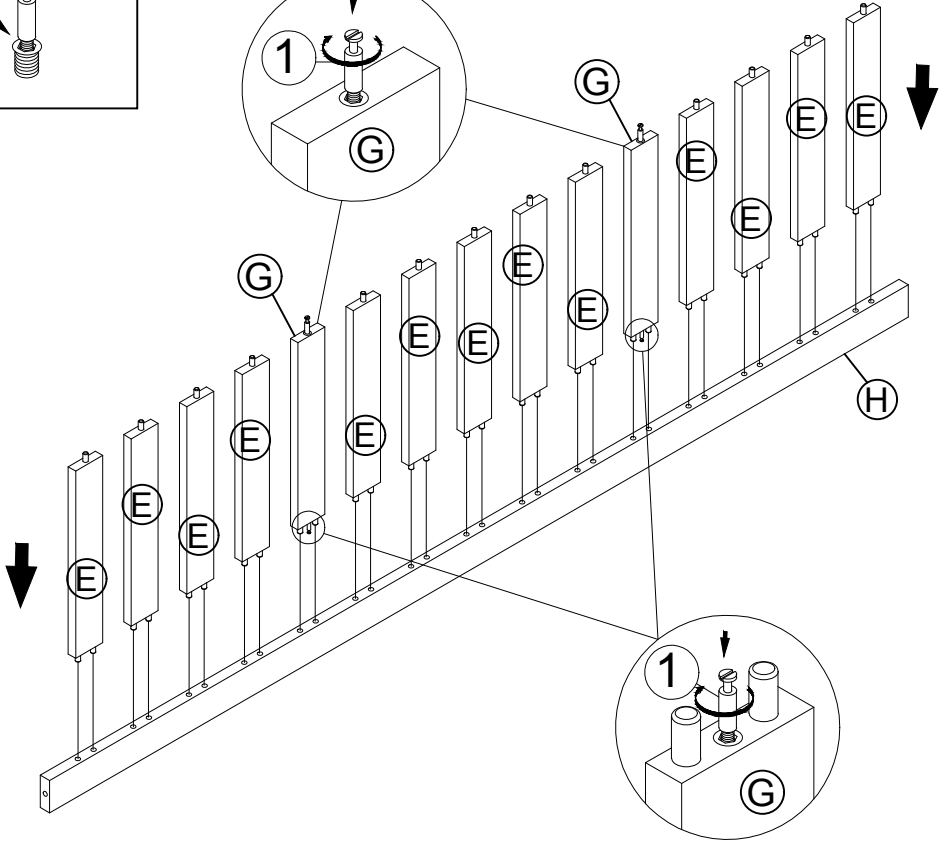
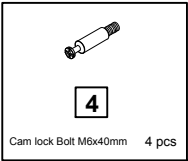
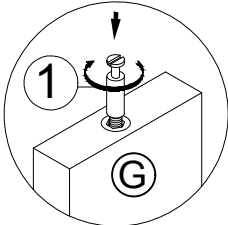
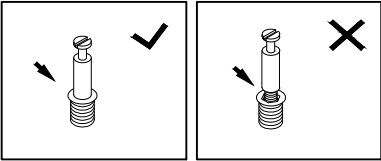

If you're having difficulty, our friendly Customer Care team is always here to help. Call us at 1.336.861.0604, email: parts@comfortpointe.com.

2

52015 KING BED

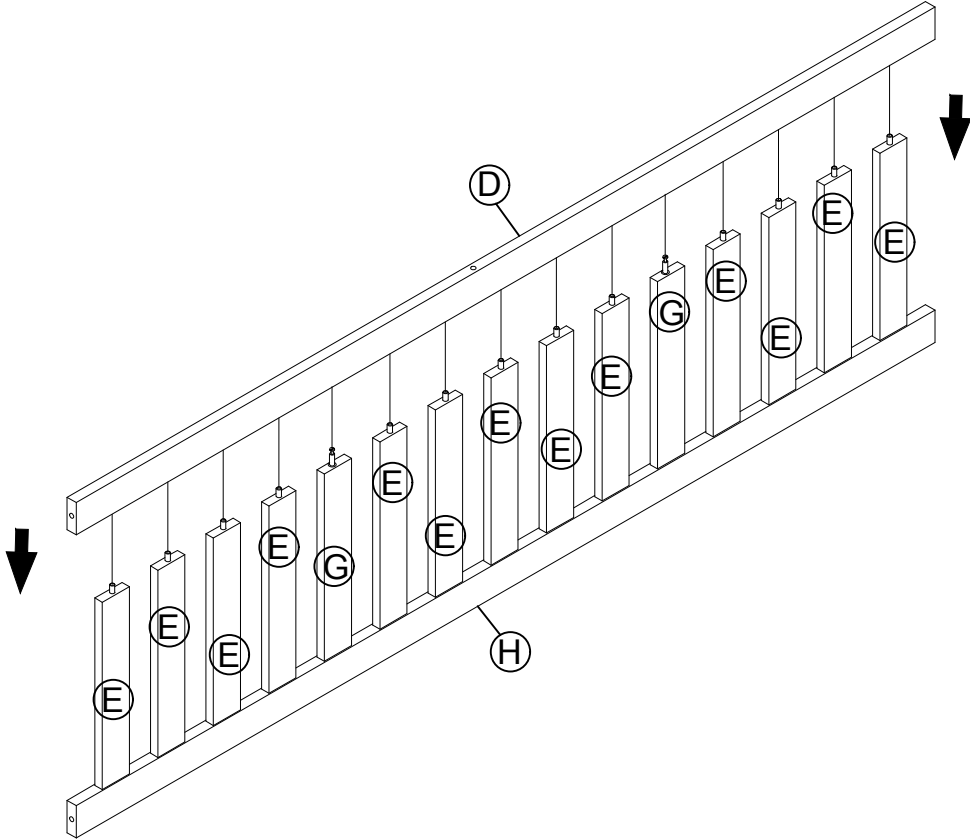



If you're having difficulty, our friendly Customer Care team is always here to help.
Call us at 1.336.861.0604, email: parts@comfortpointe.com.

VERSION 1.1 REV 09/29/2025

3

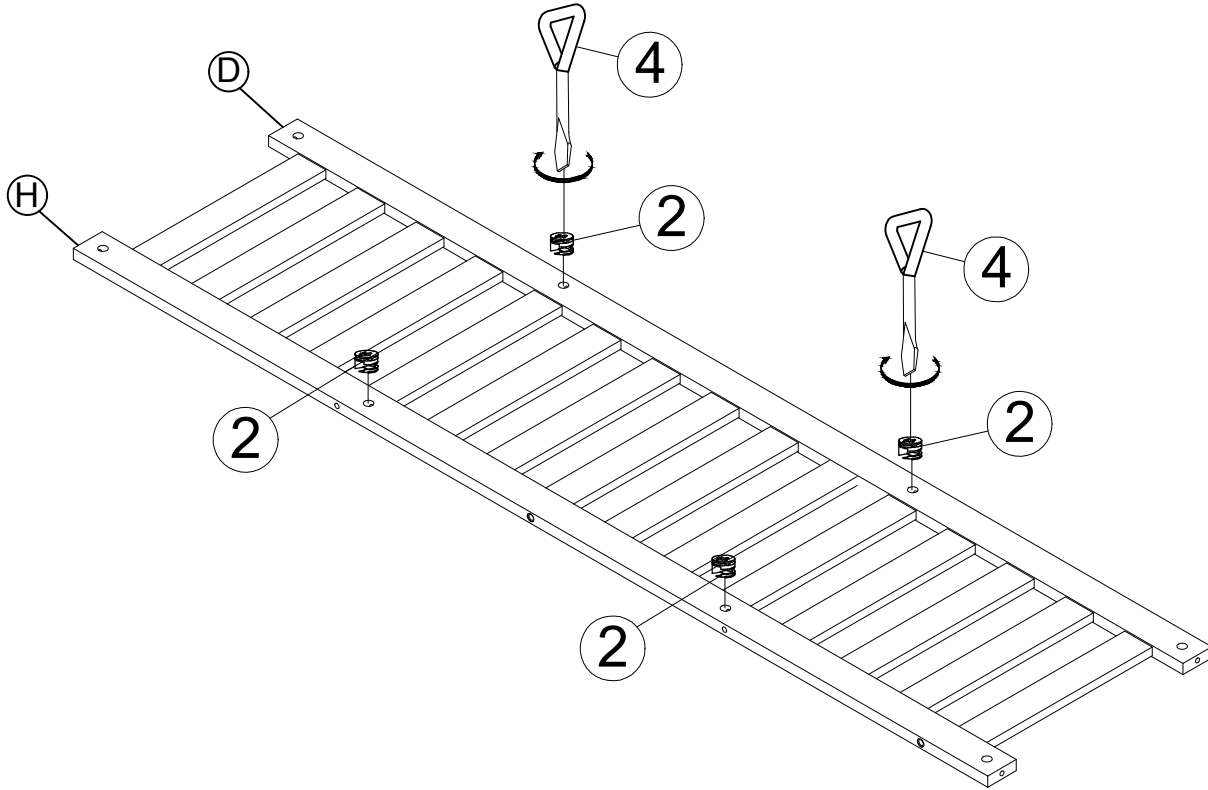
52015 KING BED



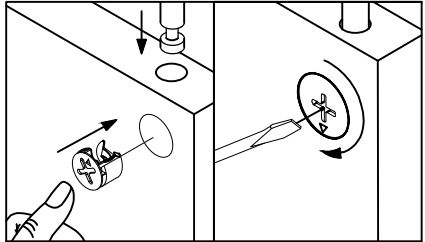

5
Cam lock Ø15mm 4 pcs



If you're having difficulty, our friendly Customer Care team is always here to help. Call us at 1.336.861.0604, email: parts@comfortpointe.com.

52015 KING BED

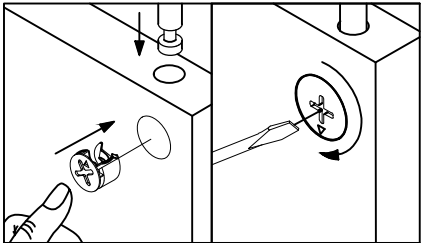
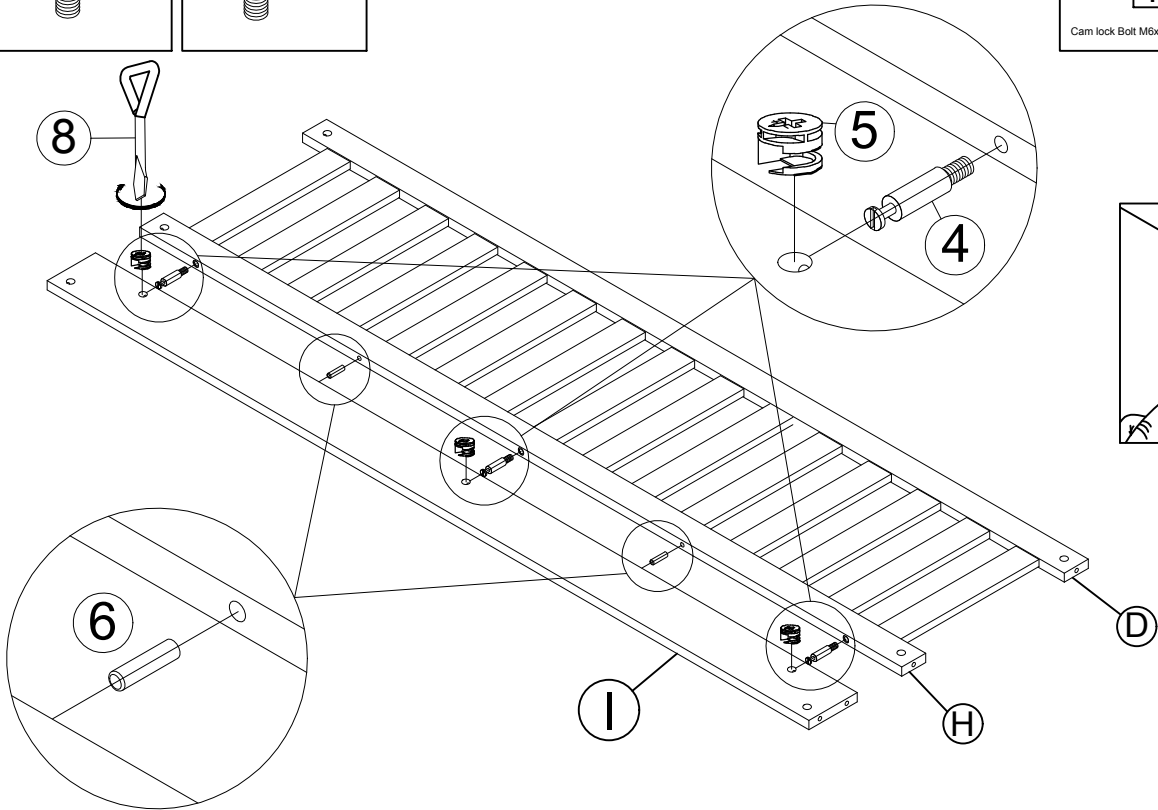
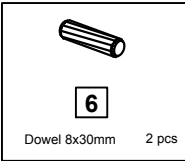
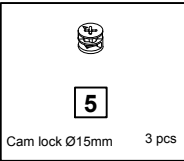
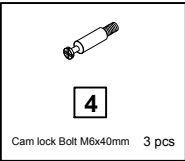
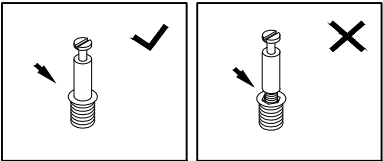
4



If you're having difficulty, our friendly Customer Care team is always here to help.
Call us at 1.336.861.0604, email: parts@comfortpointe.com.

52015 KING BED

5

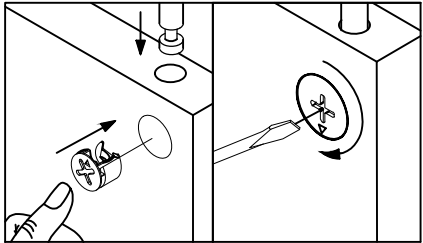
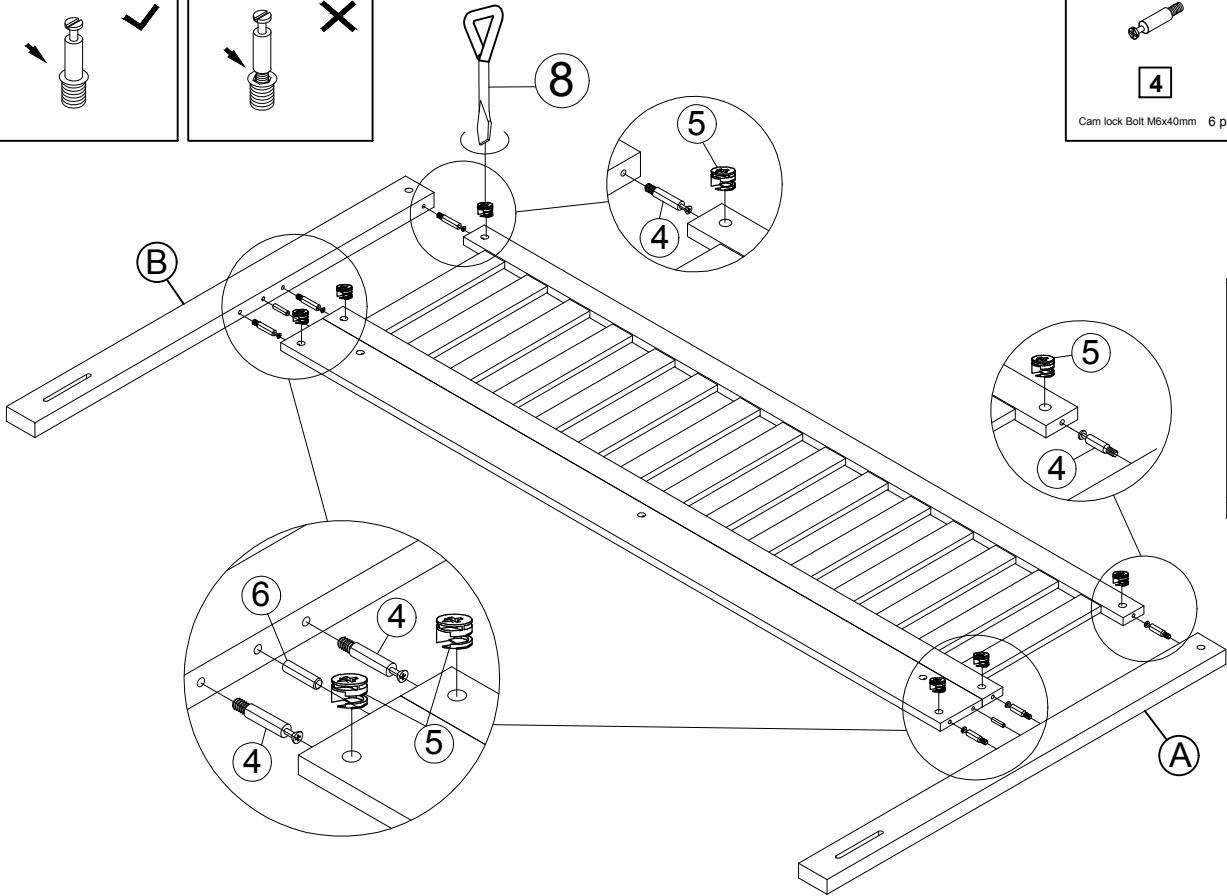
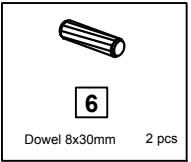
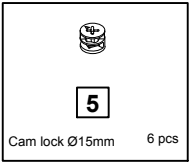
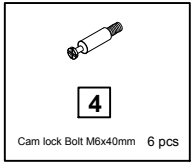
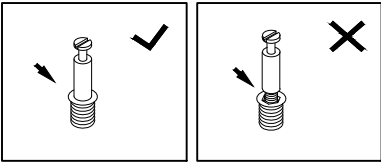

If you're having difficulty, our friendly Customer Care team is always here to help.
Call us at 1.336.861.0604, email: parts@comfortpointe.com.

VERSION 1.1 REV 09/29/2025

52015 KING BED

6

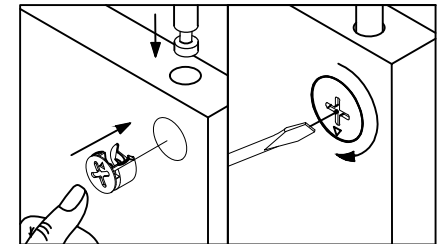
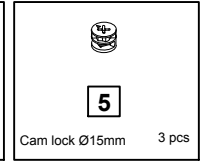
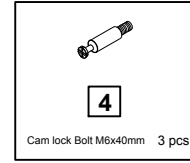
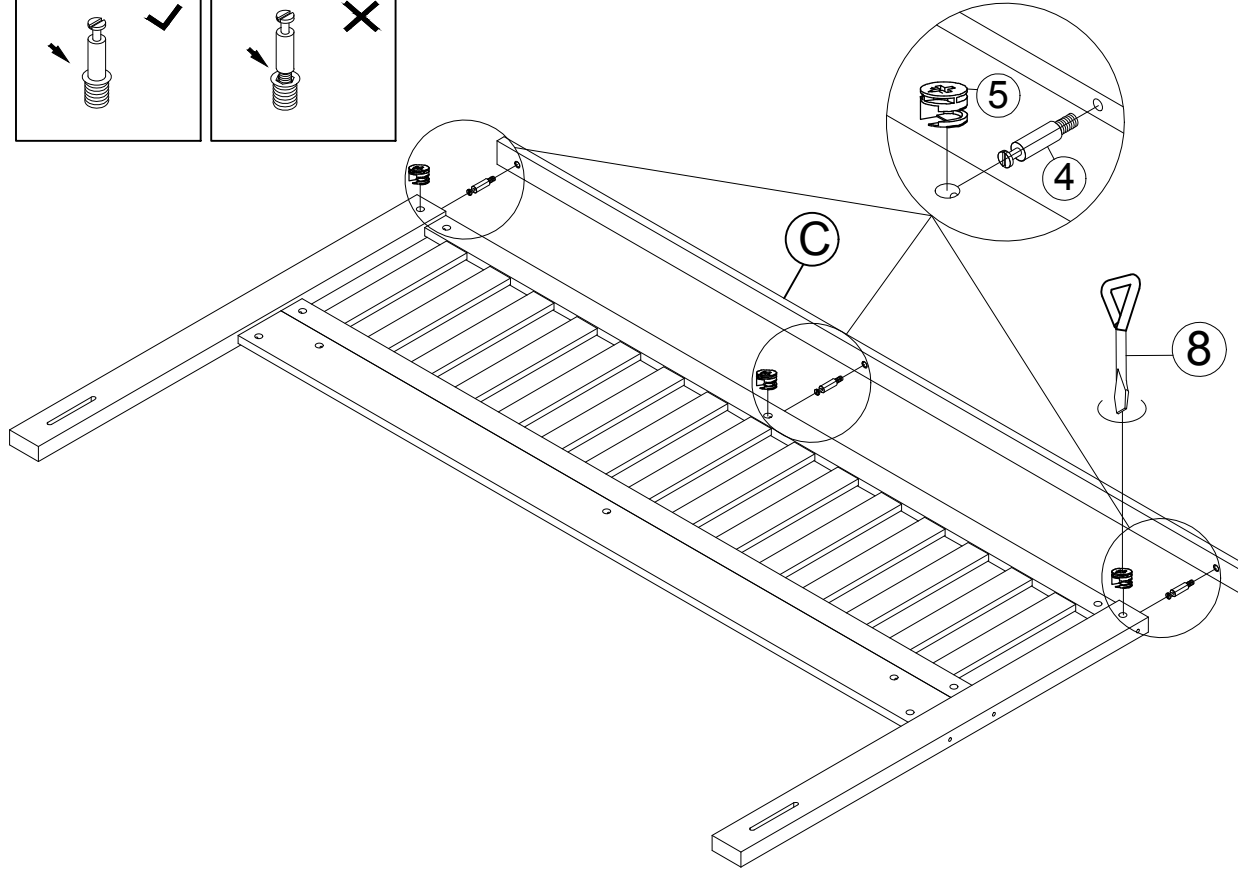
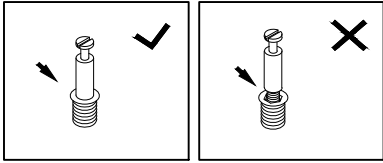

If you're having difficulty, our friendly Customer Care team is always here to help.
Call us at 1.336.861.0604, email: parts@comfortpointe.com.

VERSION 1.1 REV 09/29/2025

7

52015 KING BED

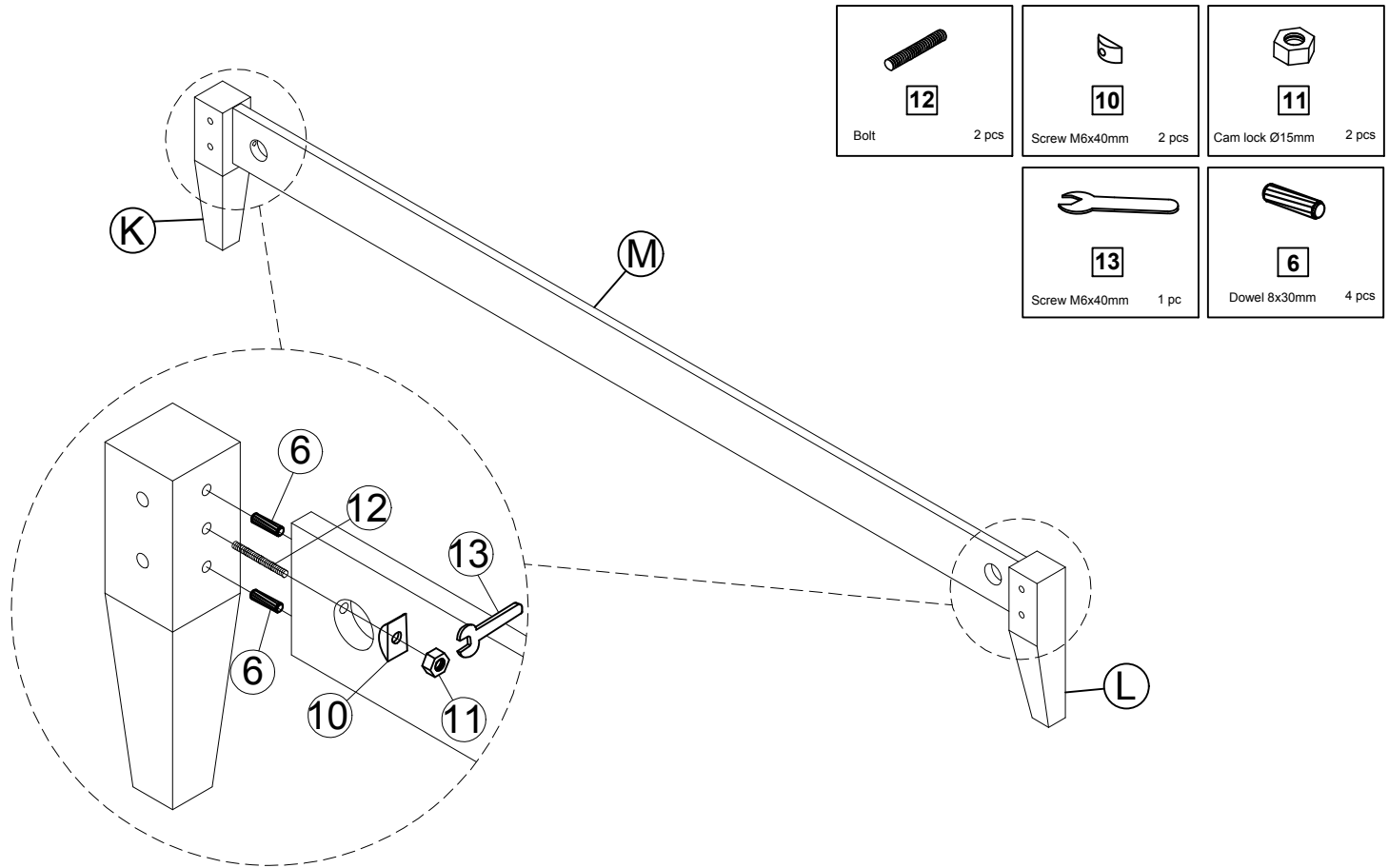



If you're having difficulty, our friendly Customer Care team is always here to help.
Call us at 1.336.861.0604, email: parts@comfortpointe.com.

VERSION 1.1 REV 09/29/2025

8

52015 KING BED

 3 Flat Washer 8 pcs	 2 Spring Washer 8 pcs	 1 Bolt 5/16"x20mm 8 pcs
--	--	--

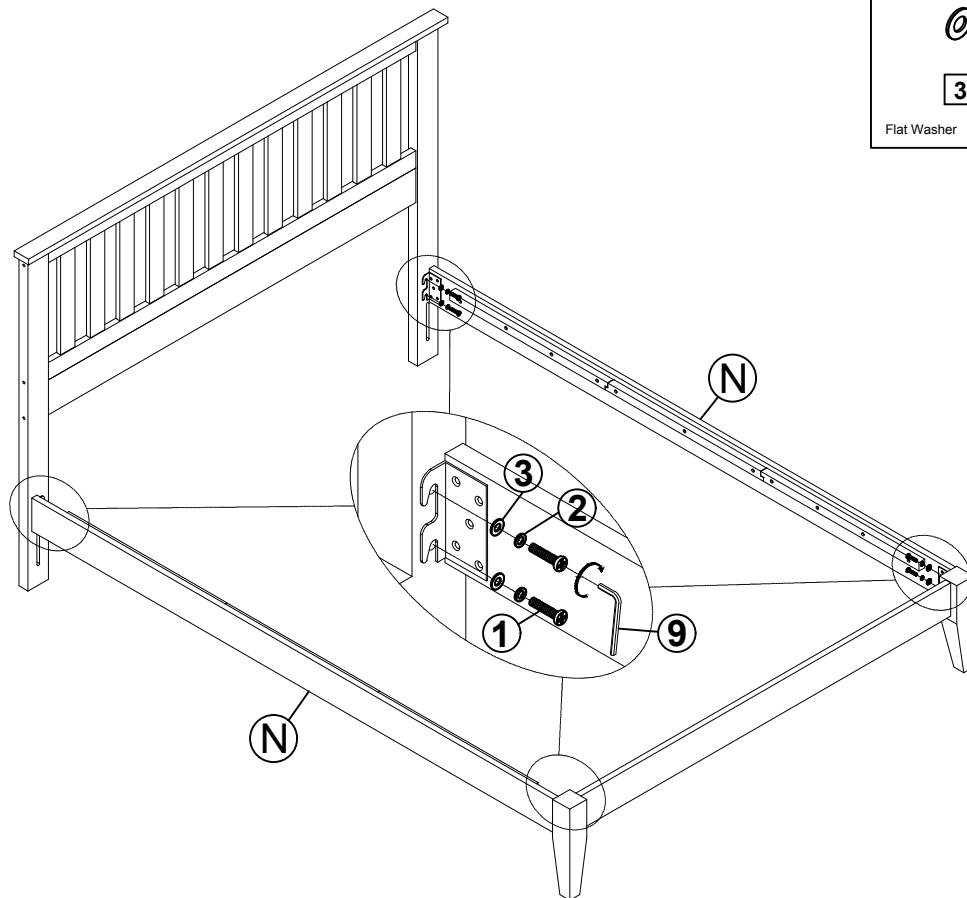

If you're having difficulty, our friendly Customer Care team is always here to help.
Call us at 1.336.861.0604, email: parts@comfortpointe.com.

VERSION 1.1 REV 09/29/2025

9

52015 KING BED

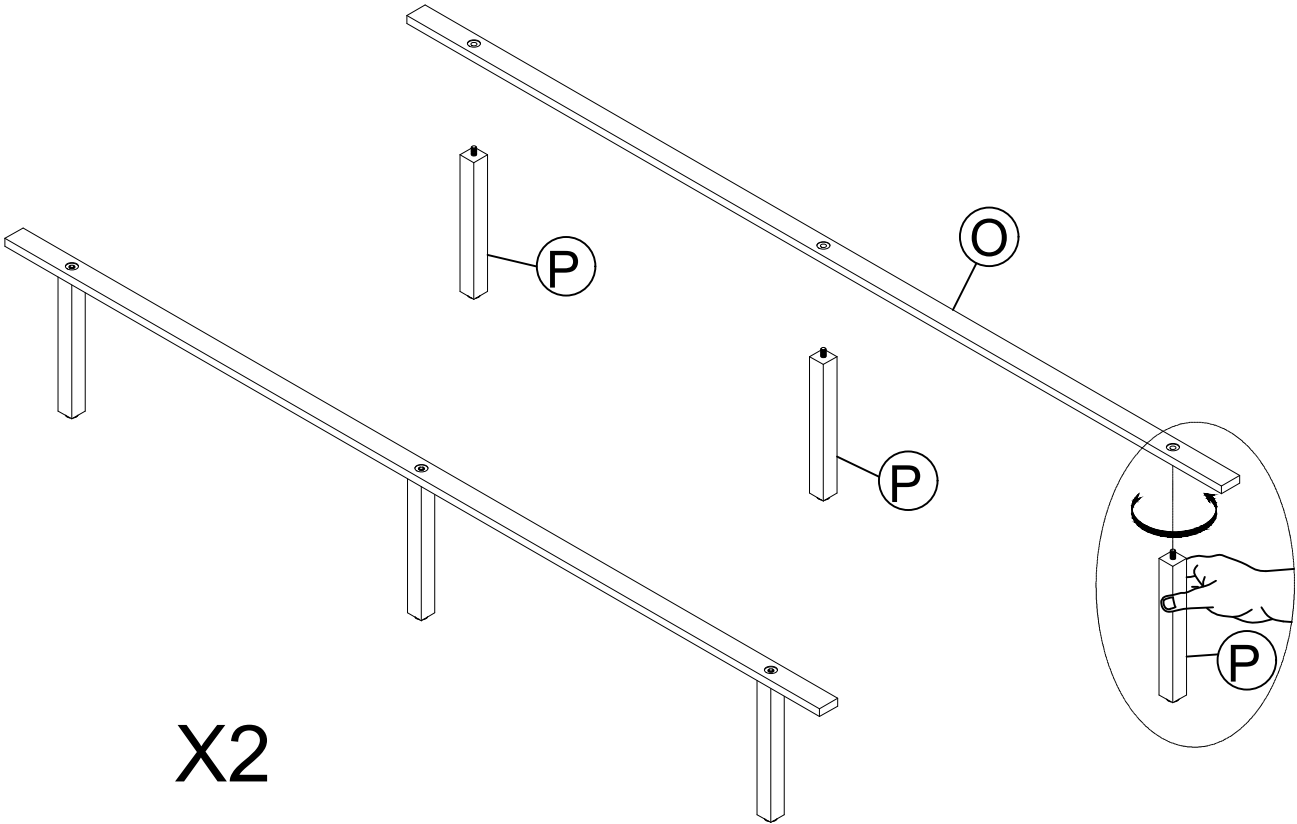

X2

If you're having difficulty, our friendly Customer Care team is always here to help.
Call us at 1.336.861.0604, email: parts@comfortpointe.com.

10

52015 KING BED

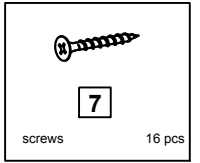
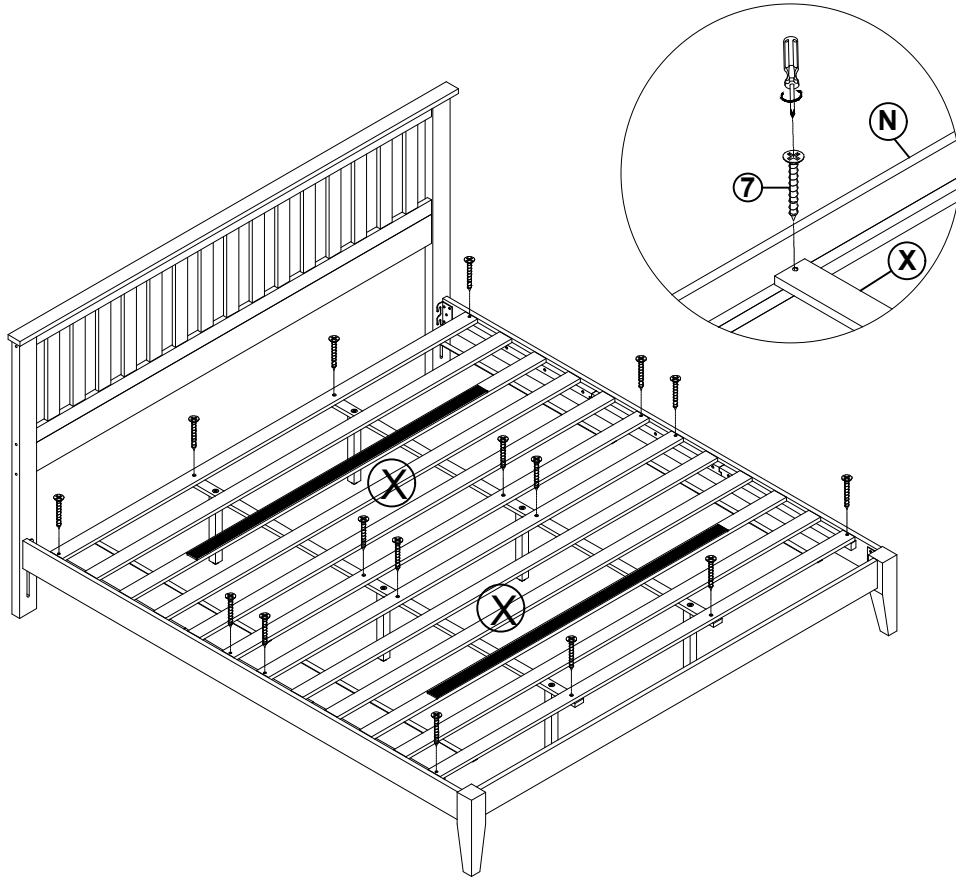

If you're having difficulty, our friendly Customer Care team is always here to help.
Call us at 1.336.861.0604, email: parts@comfortpointe.com.

VERSION 1.1 REV 09/29/2025

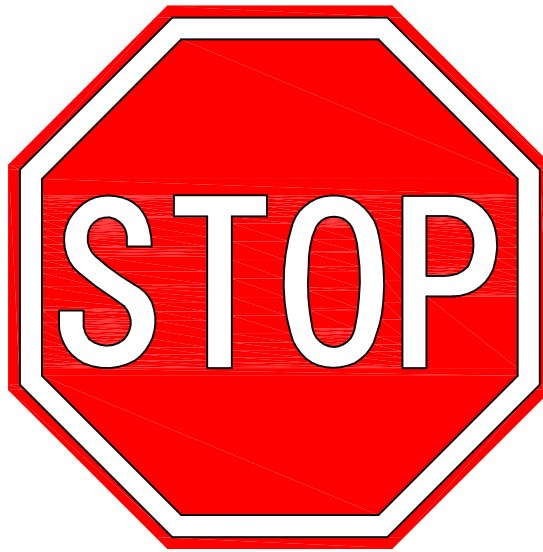

*******IMPORTANT MESSAGE*******

Please check to insure you have received all parts listed on the instruction sheet provided. If you did not receive all parts or received damaged parts please email or call the following:

Email: parts@comfortpointe.com

Phone: 336-861-0604 Contact: Parts Department

Office hours:

8am to 4pm EST Mon-Thur

8am to 3pm EST Friday

You will need to provide the item number purchased, your reference number, and identify which part is missing/damaged, all parts orders are considered priority.

Thank You