

# ASSEMBLY INSTRUCTION

## STEP:1

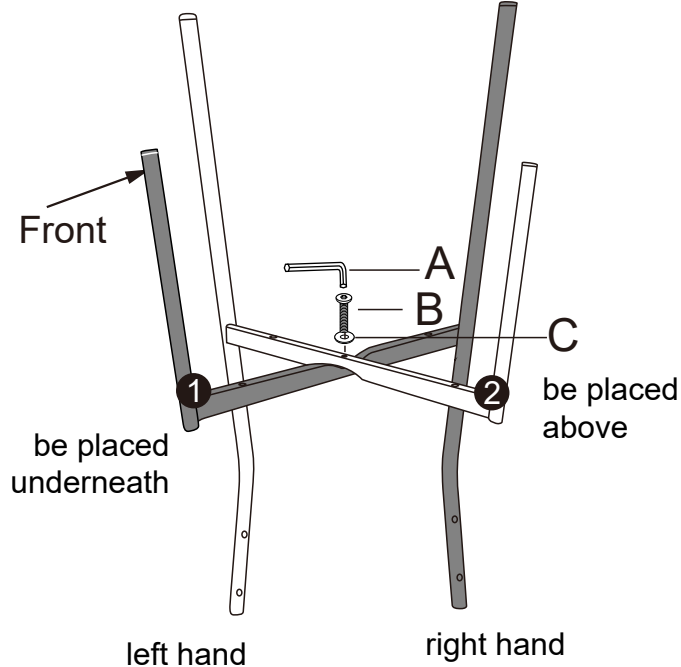

## STEP:2

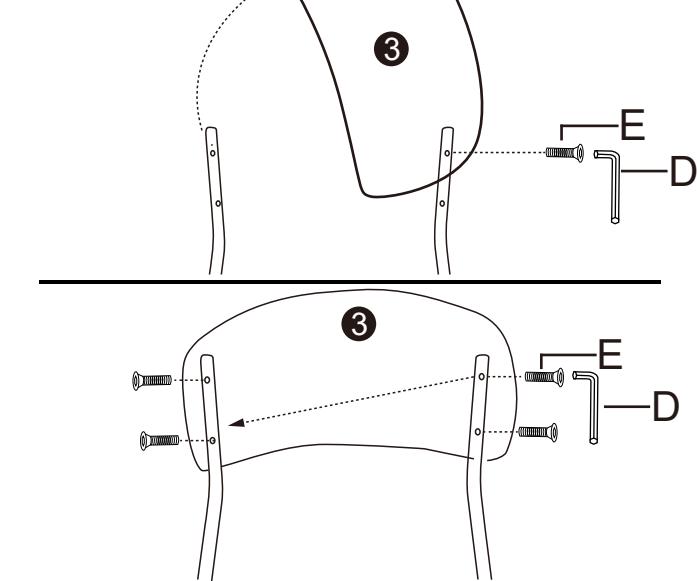

1. When installing the first hole of the backrest, because the backrest is curved and difficult to grip, you can first stand the backrest upright
2. Diagonal installation is easier
3. Do not tighten all the holes first. Tighten all the holes last



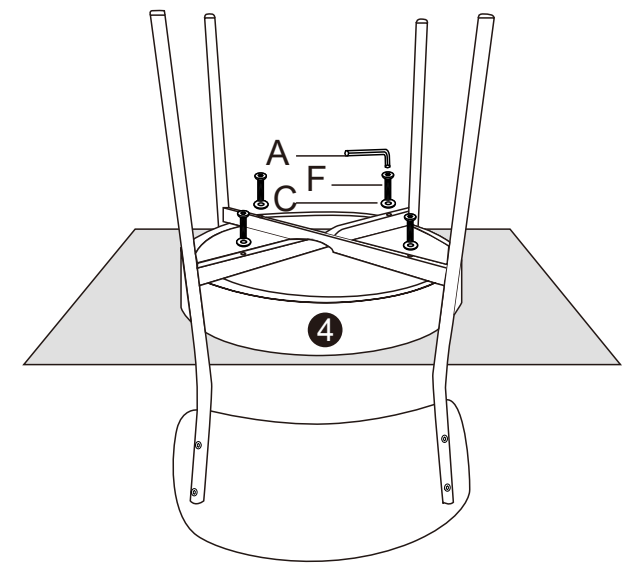

## STEP:3

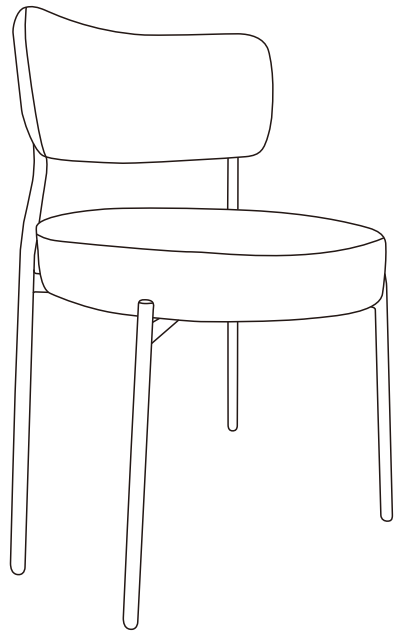

Cushion reverses for tabletop mounting

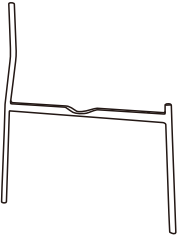
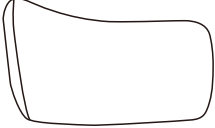
## STEP:4

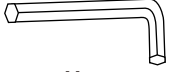
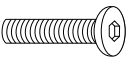

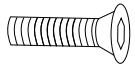
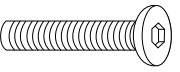
<p>1</p>  <p>x1</p>	<p>2</p>  <p>x1</p>	<p>3</p>  <p>x1</p>	<p>4</p>  <p>x1</p>	<p>A</p>  <p>#5</p> <p>x1</p>
<p>B</p>  <p>M6x30mm</p> <p>x1</p>	<p>C</p>  <p>M6x14x1.5mm</p> <p>x5</p>	<p>D</p>  <p>#4</p> <p>x1</p>	<p>E</p>  <p>M6x30mm</p> <p>x4</p>	<p>F</p>  <p>M6x50mm</p> <p>x4</p>



Honored to have you as our customer, and your satisfaction is our priority.



For returns, please contact customer service to confirm the correct return address.



If you're pleased with your purchase, we'd greatly appreciate your feedback. Thank you for your support! For future furniture purchases, feel free to ask our customer service team about exclusive discount coupons.