

INSTRUCTION MANUAL

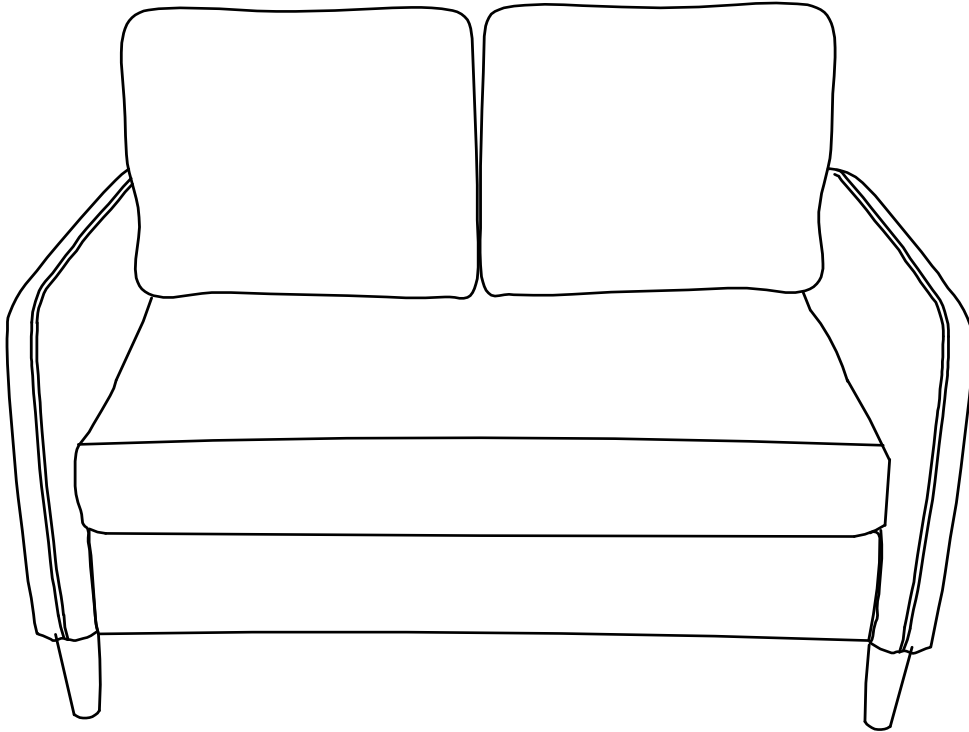

PRE-ASSEMBLY INFORMATION

IMPORTANT: Open the vacuum packaging last until you confirmed the frame suits your space, and the bottom seating part H suits your cushion expectation. Otherwise, please don't open them which will cause the item unreturnable.

NOTICE

- Please keep this manual and hand it over when you transfer the product.
- Please read the following instructions carefully and use the product accordingly.
- This summary may not include every detail of all variations and considered steps. Please contact us when further information and help are needed.
- Please do not exceed the weight limitations of this item.
- Do not stand on or use any part of this item as a step ladder.
- If any parts are missing, broken, damaged, or worn, stop using this item until repairs are made and/or factory replacement parts are installed.
- Please assemble the item in a spacious room and do not place the unwrapped product directly on the ground to avoid damage.
- Do not use this item in a way inconsistent with the manufacturer's instructions as this could void the product warranty.
- Periodically inspect screw tightness while the product is in use. If necessary, retighten to ensure structural integrity.
- To avoid the potential dangers of suffocation, please keep all parts and packaging (films, plastic bags and foam, etc.) away from children and pets.
- Do not use or store this item in the proximity of open flame or flammable/combustible chemicals.
- Do not expose product to direct sunlight exposure or rain, and do not put it in a humid place. Failure to do so may accelerate the distortion or discoloration.

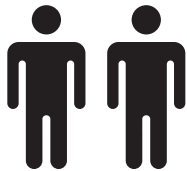

TWO PERSON ASSEMBLY



UP TO 30 MINUTES
FOR ASSEMBLY



WEIGHT LIMITATION
580LBS





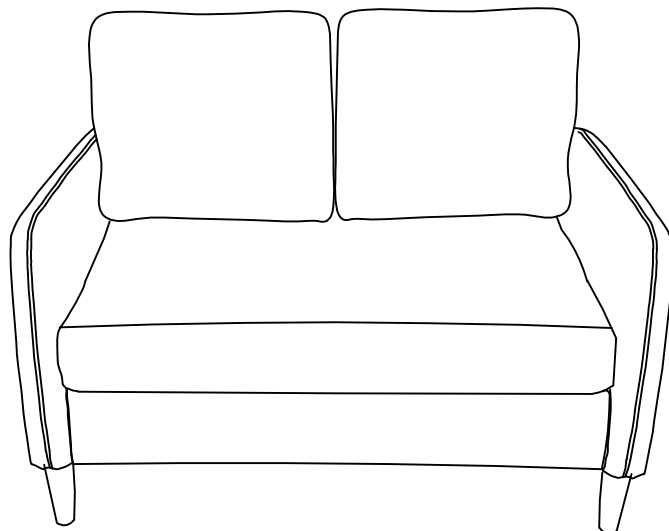
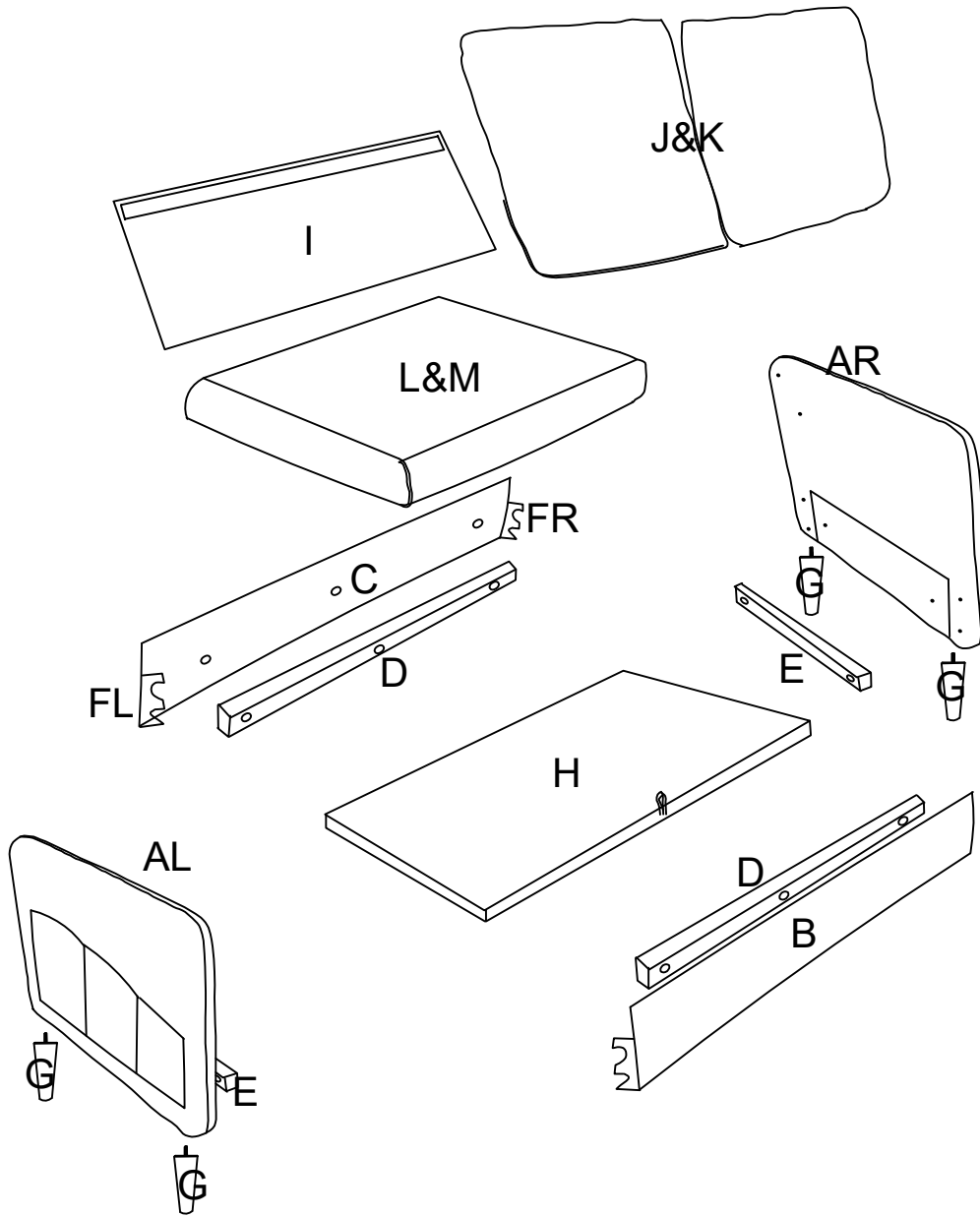

IMPORTANT

1. We recommend open the vacuum sealed cushions and pillows after the sofa frame is installed.
2. Remember to remove the parts packed under the bottom of seat frame.
3. Do not tighten bolts / screws completely until all bolts / screws are lined up and inserted into holes.
4. Do not over tighten screws and bolts to avoid stripping.
5. Please use hand tools to assemble this product. If you're using power tools, remember to set the tool to low torque to avoid damage.

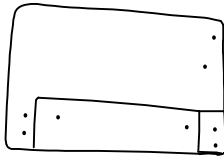
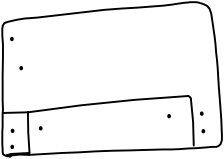
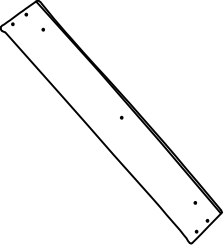
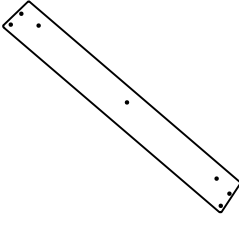
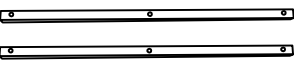
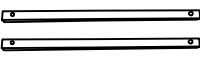
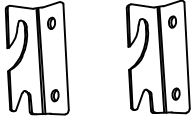
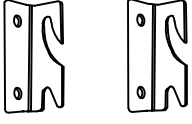
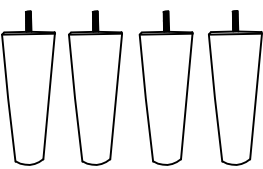
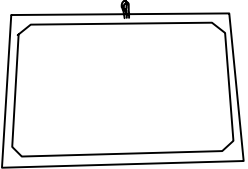
COMPONENTS

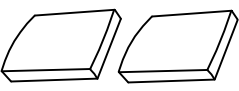
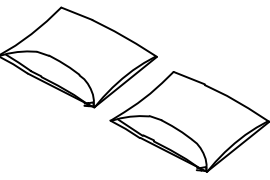
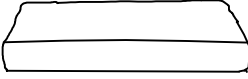
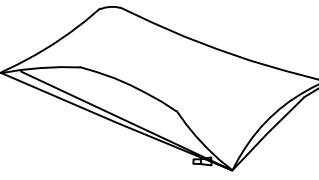

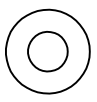
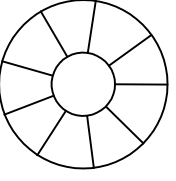
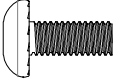
COMPONENTS

AL 	AR 	B 	C 
Left Armrest (1PC)	Right Armrest (1PC)	Front Panel(1PC)	Back Panel(1PC)
D 	E 	FL 	FR 
Front and Back Rod(2PCS)	Side Rod(2PCS)	Left Hanger(2PCS)	Right Hanger(2PCS)
G 	H 	I 	J 
Leg(4PCS)	Seat Frame (1PC)	Back Frame(1PC)	Back Cushion(2PCS)
K 	L 	M 	N 
Back Cushion Cover (2PCS)	Seat Cushion (1PC)	Seat Cushion Cover (1PC)	Allen Key M6(1PC)
O 	P 	Q 	R 
Gasket (26PCS)	Plastic Gasket(4PCS)	Short Screw M6*16(8PCS)	Middle Screw M6*35(18PCS)
S 			
Long Screw M6*60(4PCS)			

ASSEMBLY STEPS

STEP1 Screw the sofa Leg G with Plastic Gasket P into the Armrest (AL/AR).

AL		1
AR		1
G		4
P		4

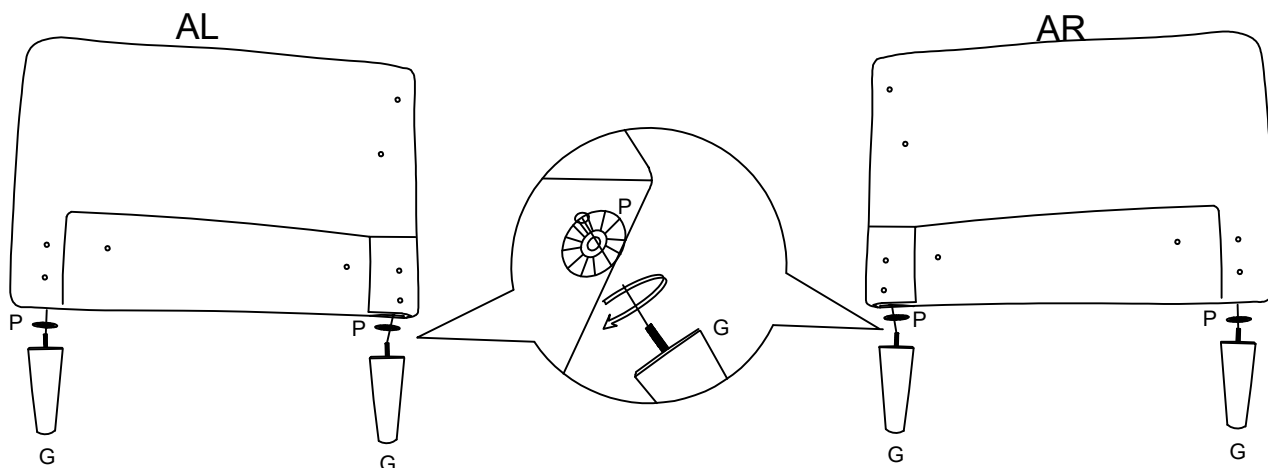

STEP2 Attach the Side Rod E to the Armrest AL/AR with Middle Screws R and Gasket O using an Allen Key M6.

AL		1
AR		1
E		2
R		4
N		1
O		4

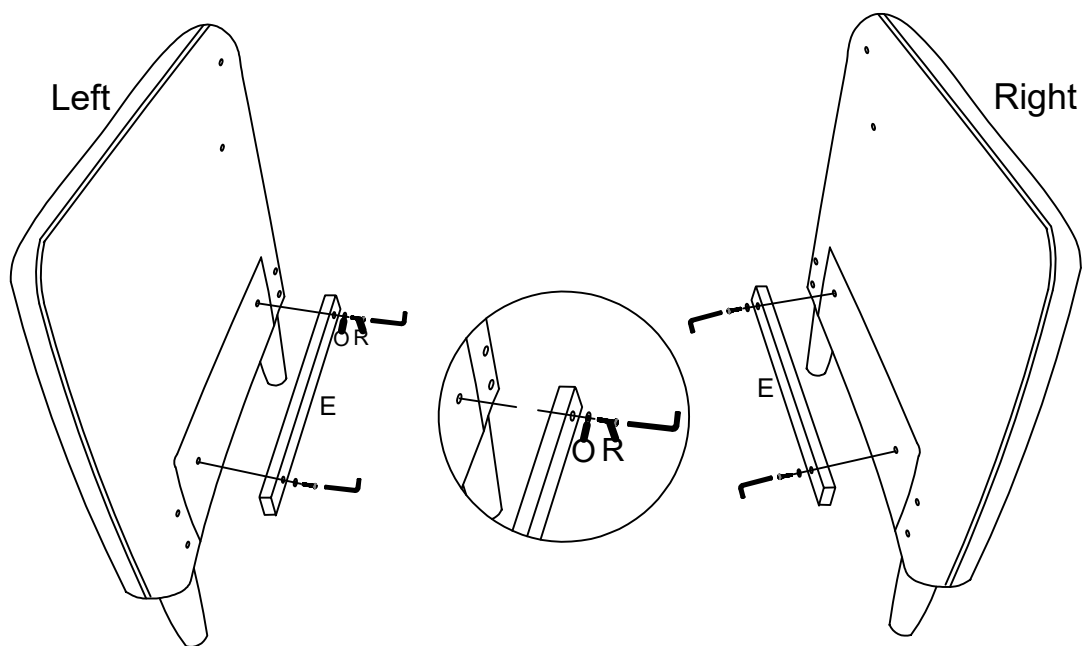

STEP3

Attach the Left & Right Hanger FL/FR to the Front and Back Panel B&C with Short Screws Q and Gasket O using an Allen Key M6.

FL		2
FR		2
B		1
C		1
Q		8
O		8
N		1

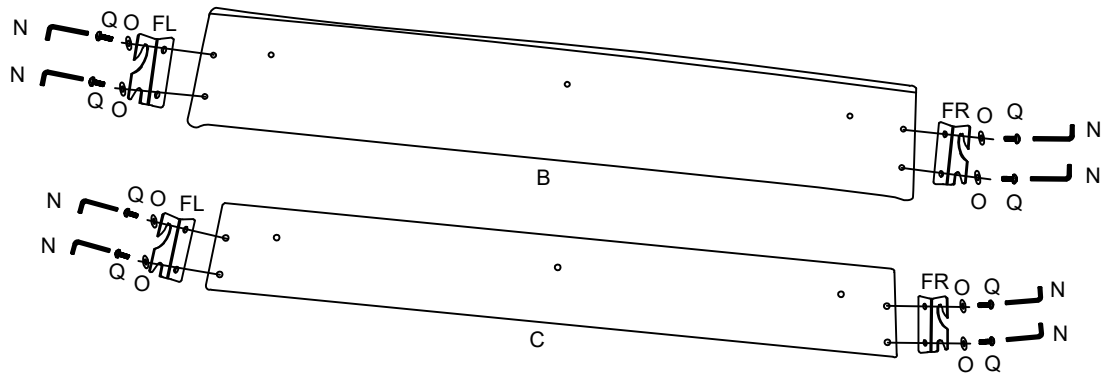

STEP4

Attach the Front and Back Rod D to the Front and Back Panel B&C with Middle Screws R and Gasket O using an Allen Key M6.

B		1
C		1
D		2
O		6
R		6
N		1

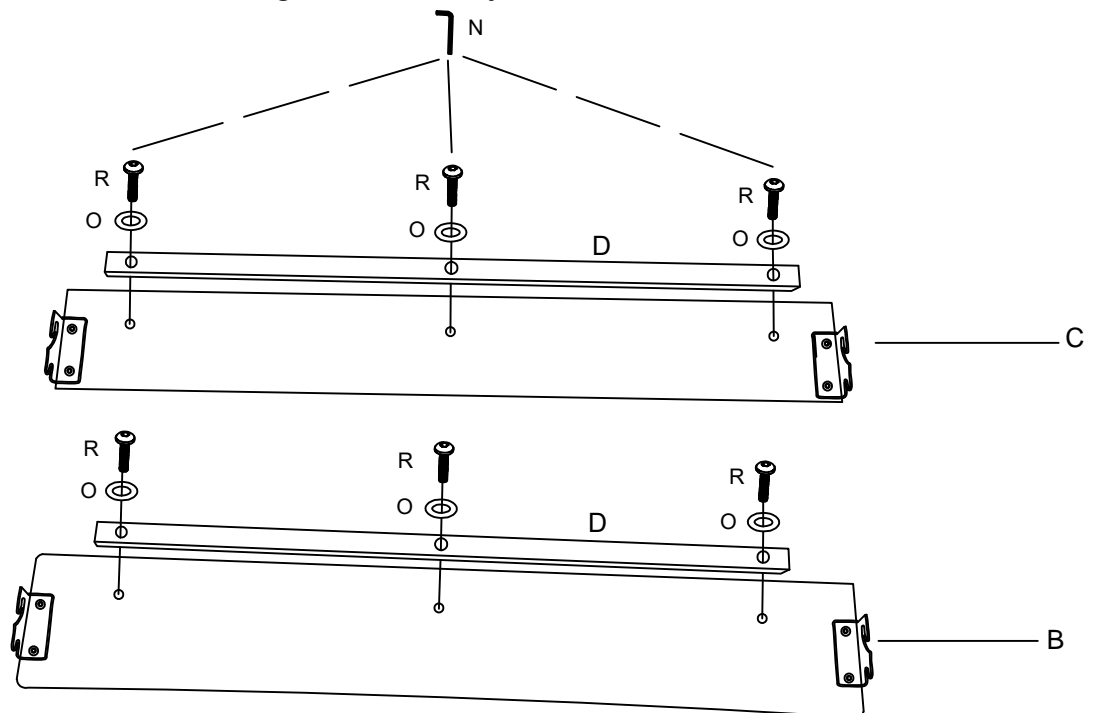

STEP5

Insert Middle Screws R into Armrest AL/AR.

Note: Do not over-tighten. Leave 2/3 of the screw opening for the next step of inserting the front and back panel.

AL		1
AR		1
R		8
O		8
N		1

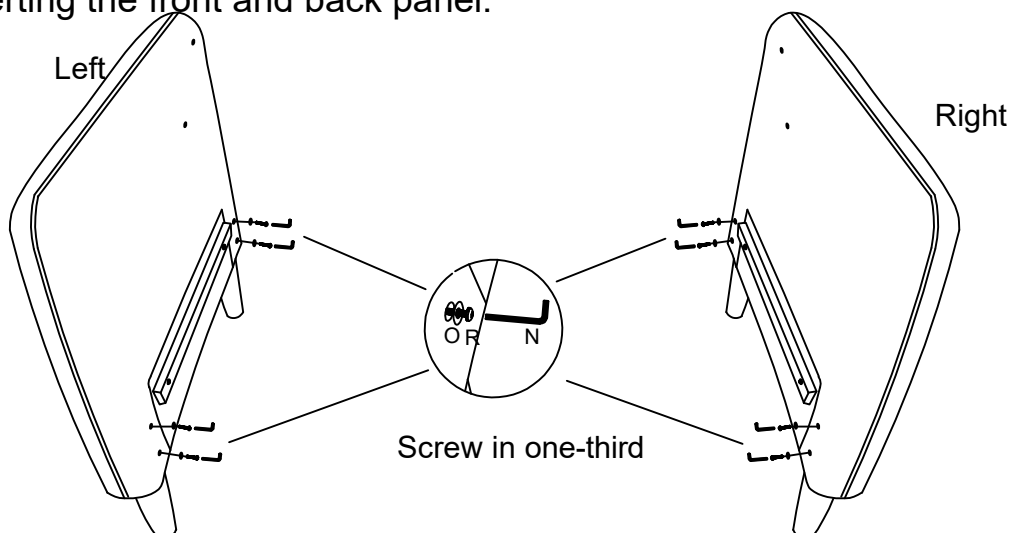

STEP6 Snap the Back Panel C into the Armrest AL/AR and tighten them Middle Screws R.

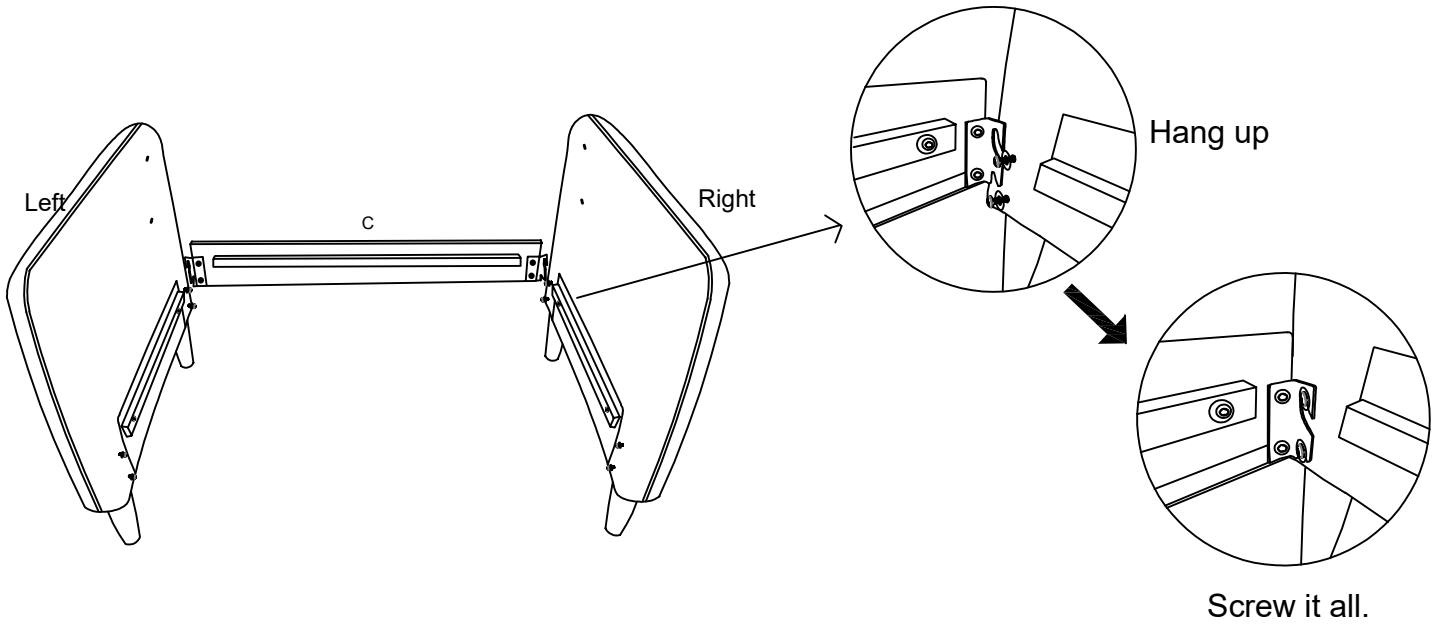
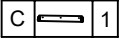

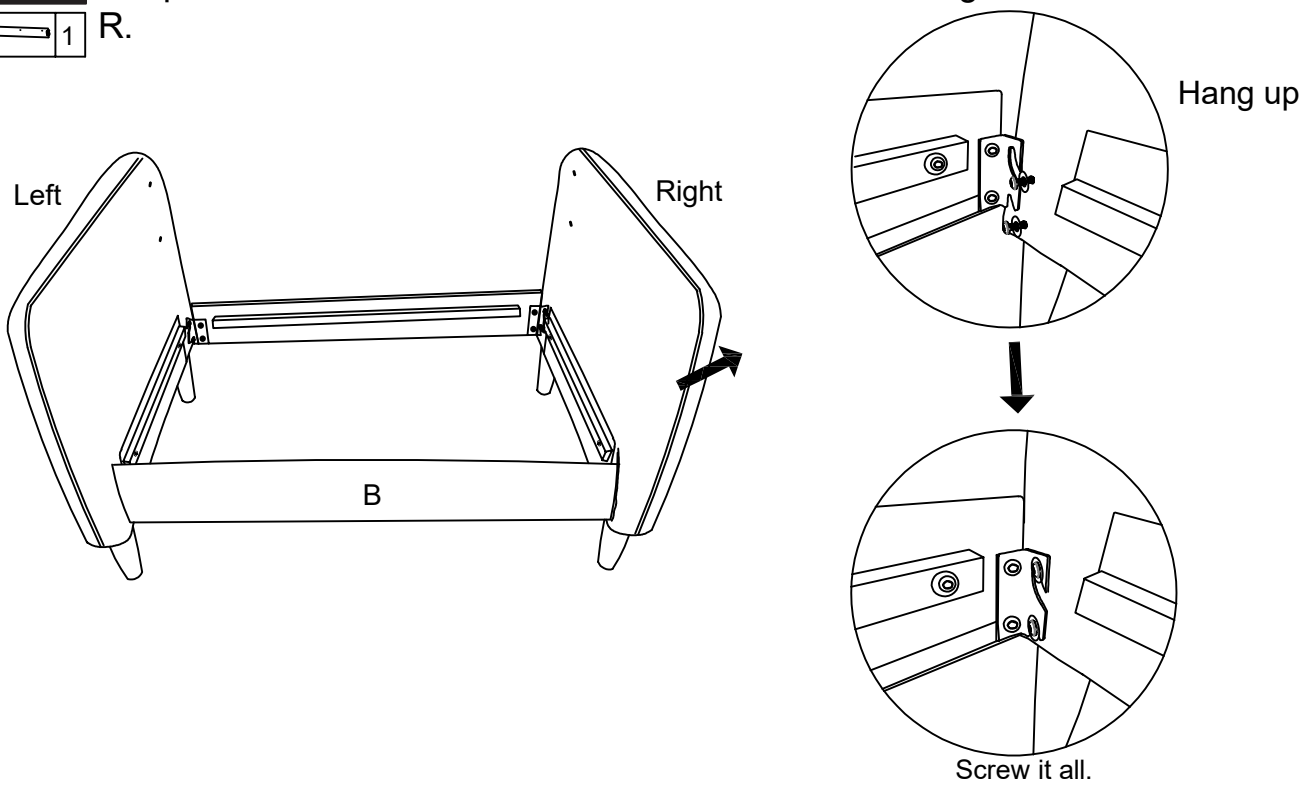
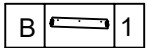

STEP7 Snap the Front Panel B into the Armrest AL/AR and tighten them Middle Screws R.



STEP 8

Attach the Back Frame I and Left and Right Armrest AL/AR together with Long Screw S, and then pull down the fabric to attach the velcro.

I		1
S		4

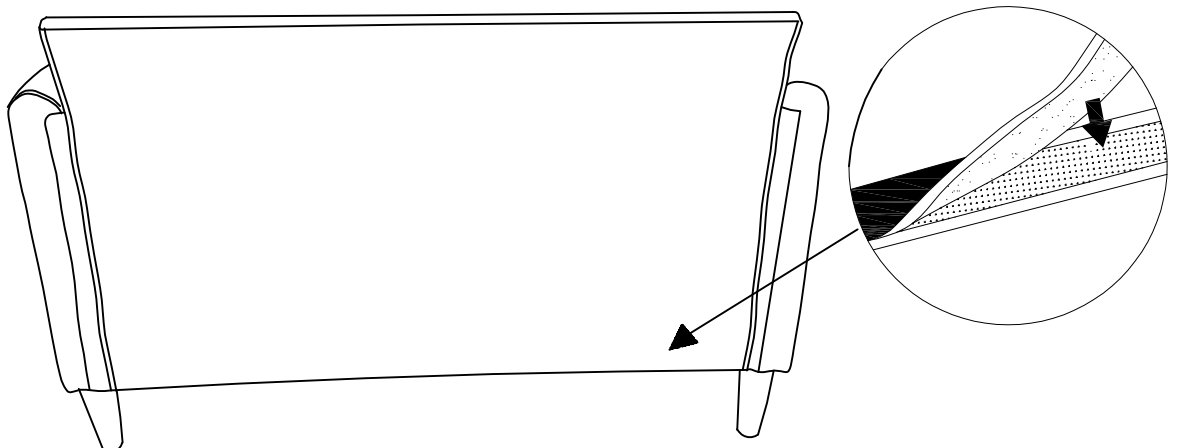
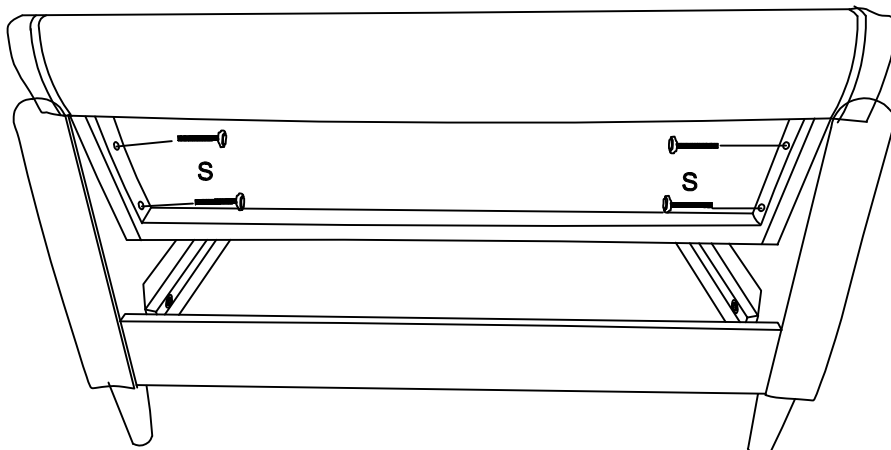
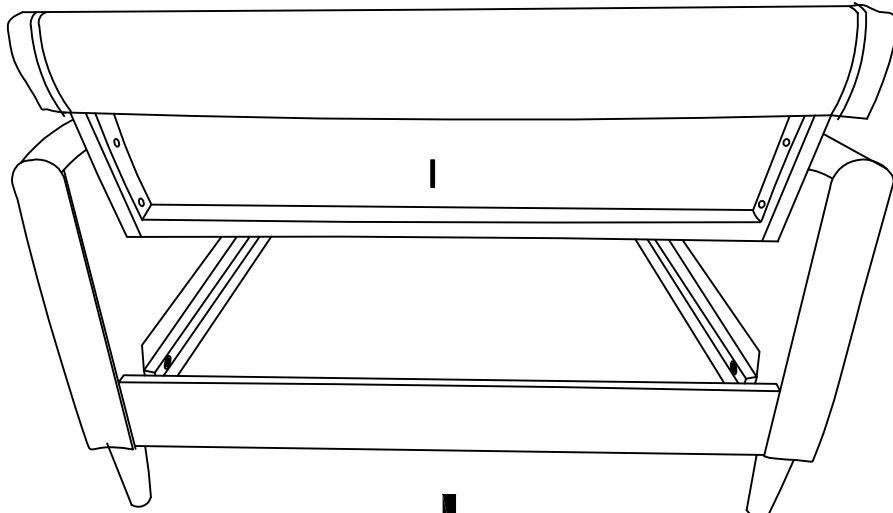

STEP9

If you confirmed the sofa frame fits your space and have a good feeling on seating Part H, then just go ahead to open the vacuum packages for Part J and L.

K		2
M		1
J		2
L		1

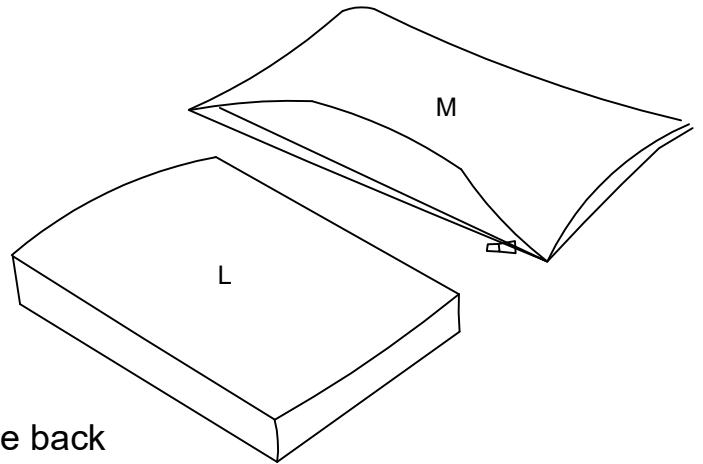
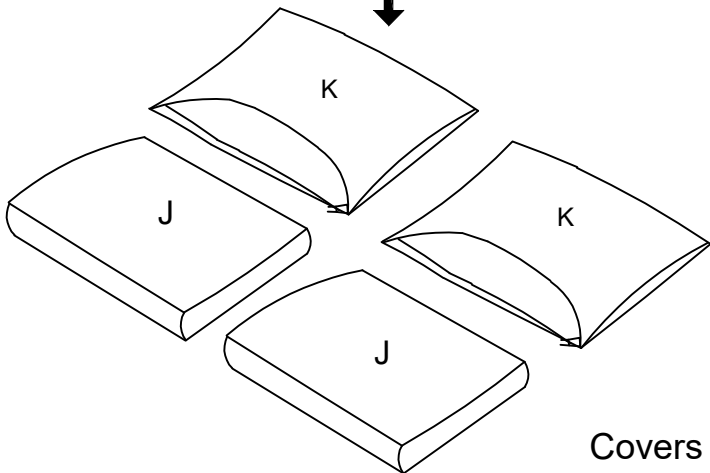
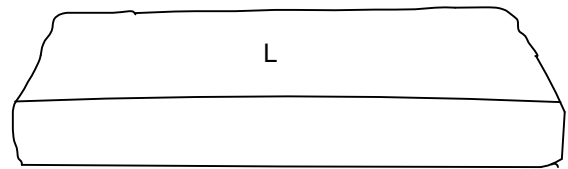
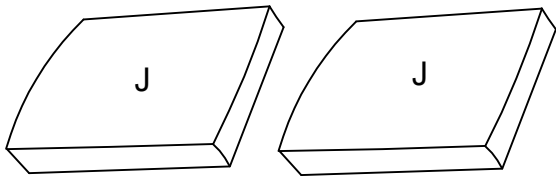
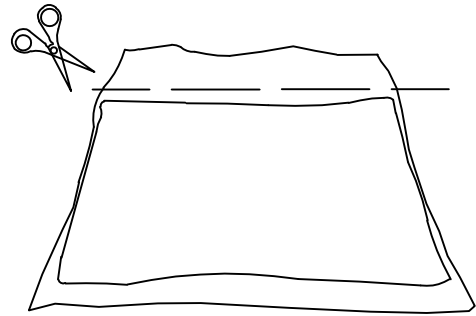
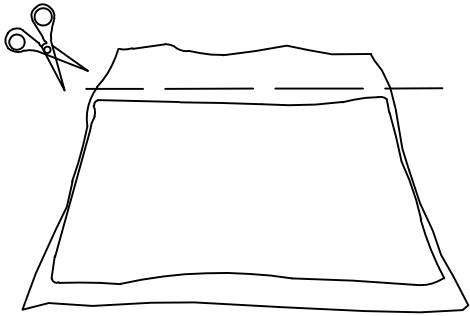

Covers the back cushion and seat cushion.

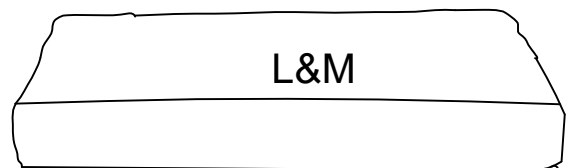
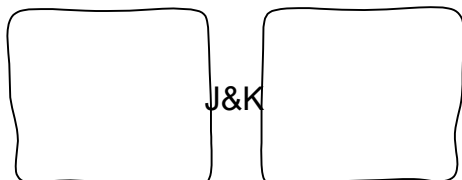

STEP10 Put on the seat frame H.

H		1
---	---	---

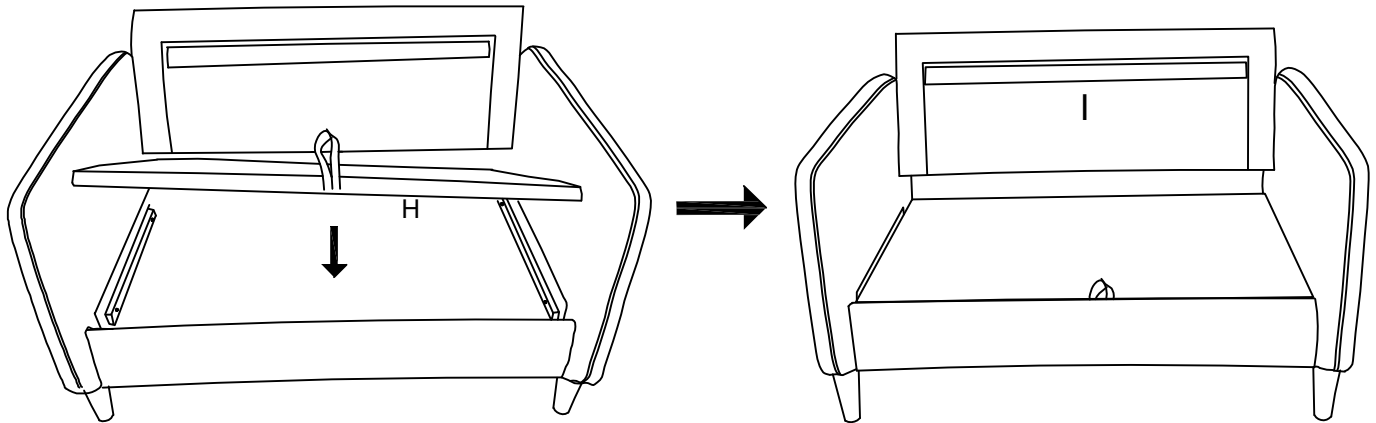

STEP11 Place the seat/back cushion on the sofa as shown in the picture and secure it firmly to the sofa body using the velcro fasteners on the base/back cushion. If the fabric wrinkles, please wait for 72 hours for the cushions fully rebound back.

J&K		1
L&M		2

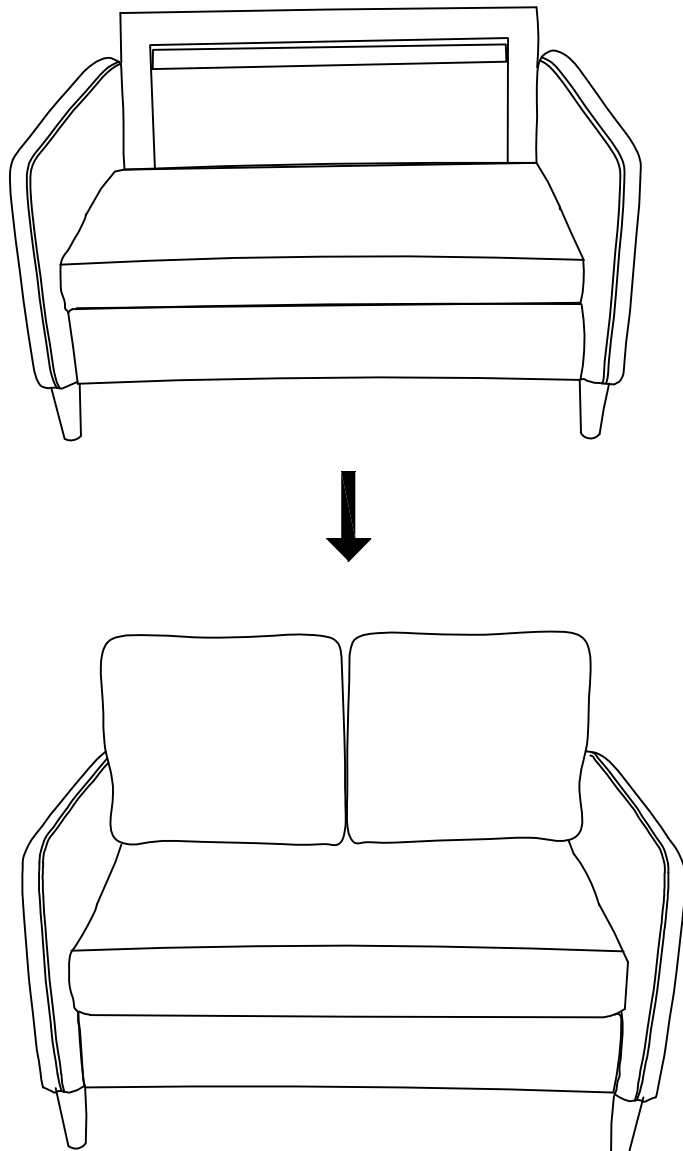



WARNING

Manufacturer and seller expressly disclaim any and all liability for personal injury, property damage or loss, whether direct, indirect, or incidental, resulting from the incorrect attachment, improper use, inadequate maintenance, unapproved modification, or neglect of this product.