

Wall Cabinet Instruction Manual

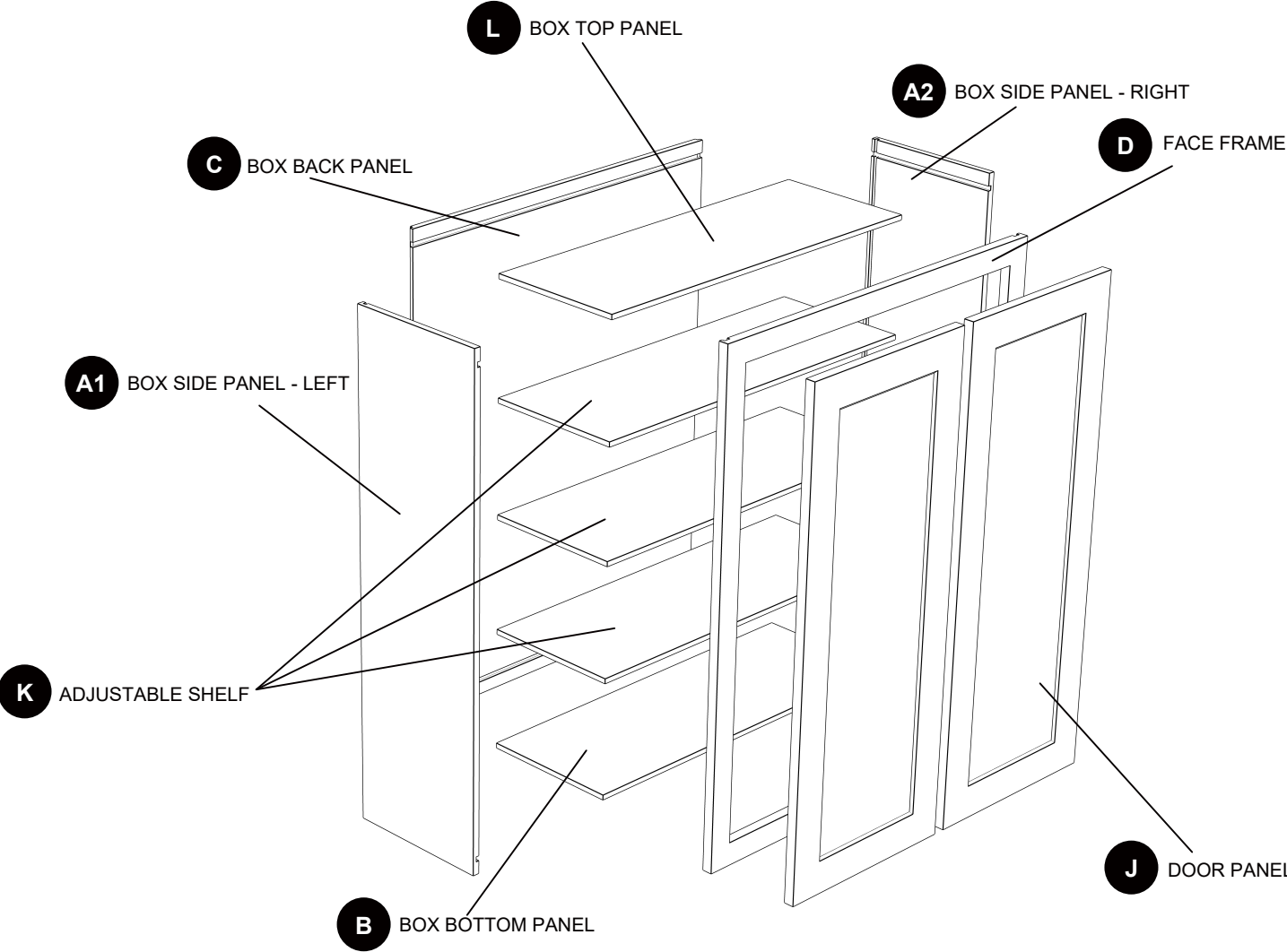

PART	DESCRIPTION
A1	Box side panel - left
A2	Box side panel - right
B	Box bottom panel
C	Box back panel

PART	DESCRIPTION
D	Face frame
J	Door panel
K	Adjustable Shelf
L	Box top panel

CAUTION

- Be sure to carefully remove all parts from the carton and ensure that there are no damages to any of them.
- The hardware should be kept away from children when unpacking and assembling this product. Two adults are recommended for assembly.
- Follow the instructions in the instruction manual carefully and strictly to ensure that the product is assembled and operates as intended.
- Do not tighten all the screws until all the adjacent parts have been properly connected. Please do not throw away extra screws. Please refer to the actual product for the screw hole position.

HARDWARE CONTENTS

- CC** Soft-close hinge x 6
Be careful the length of the screws.

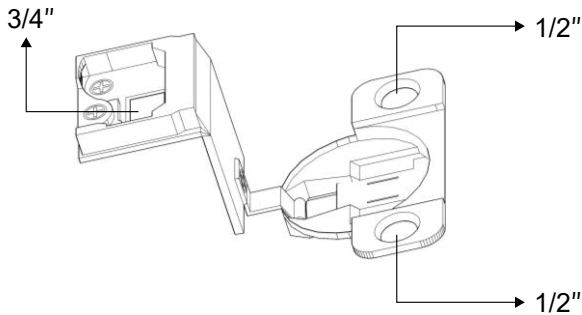

Included:
1/2" Flat Head Phillips Screw x 12



3/4" Round Head Phillips Screw x 6

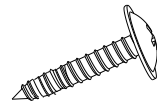

- EE** Corner brace x 16

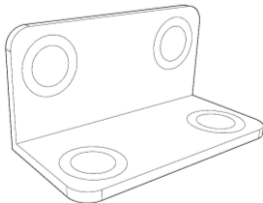

Included:
1/2" Round Head Phillips Screw x 64

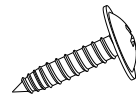

- FF** Adjustable shelf clip x 12

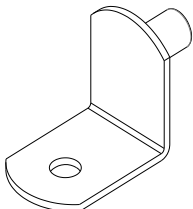

- GG** 1" Flat head Phillips screw x 8

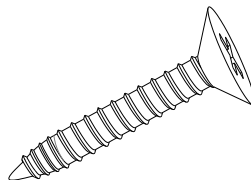

- HH** Rubber bumper x 4

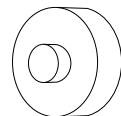

TOOLS REQUIRED (NOT INCLUDED)

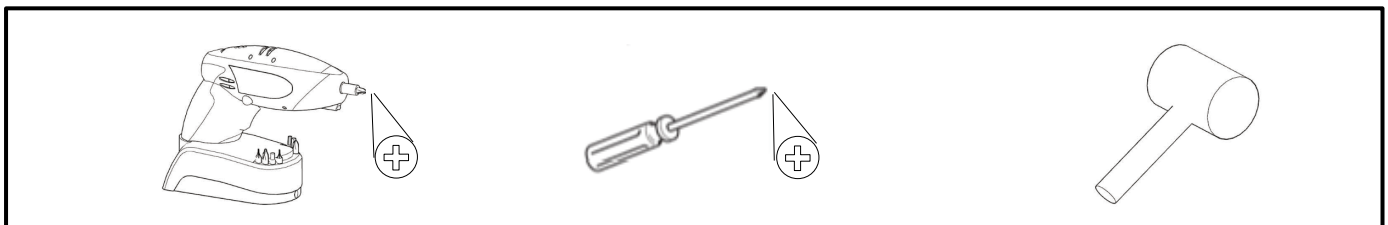

INSTALLATION OVERVIEW

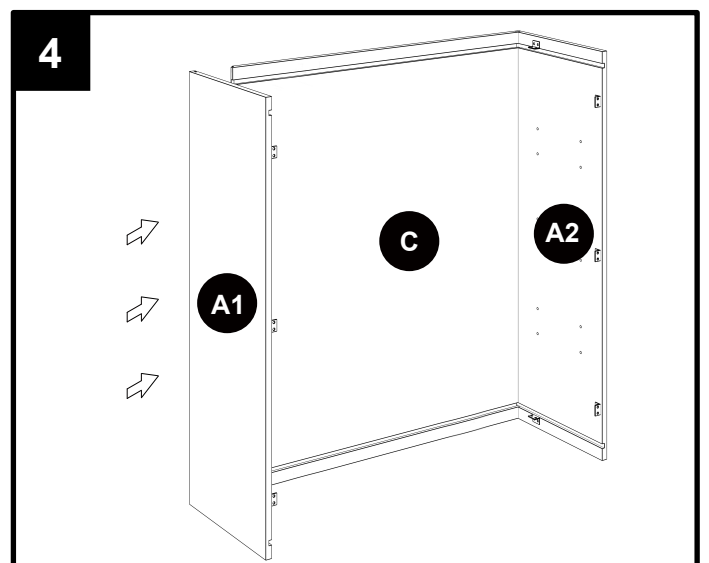
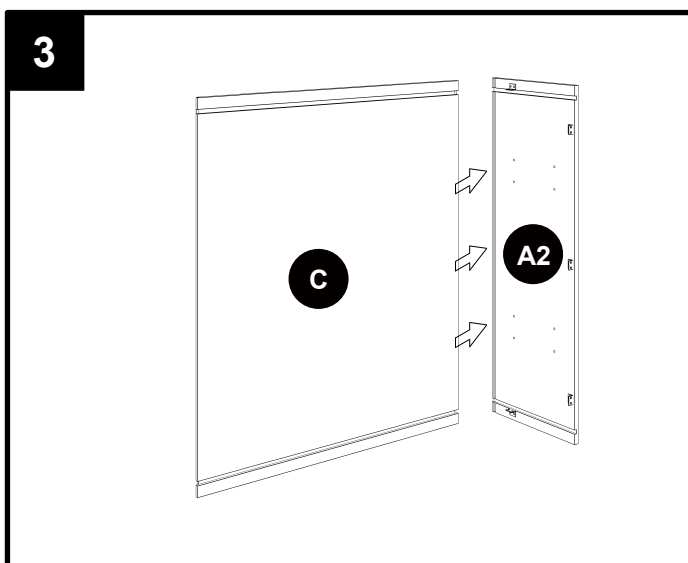
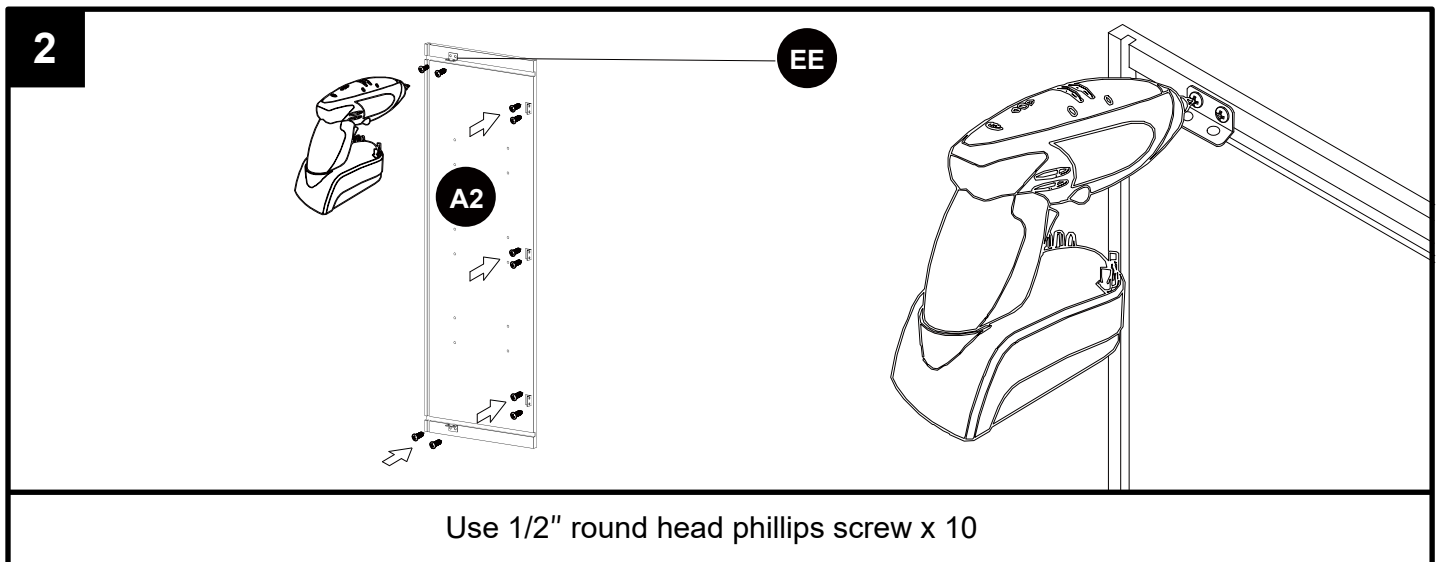
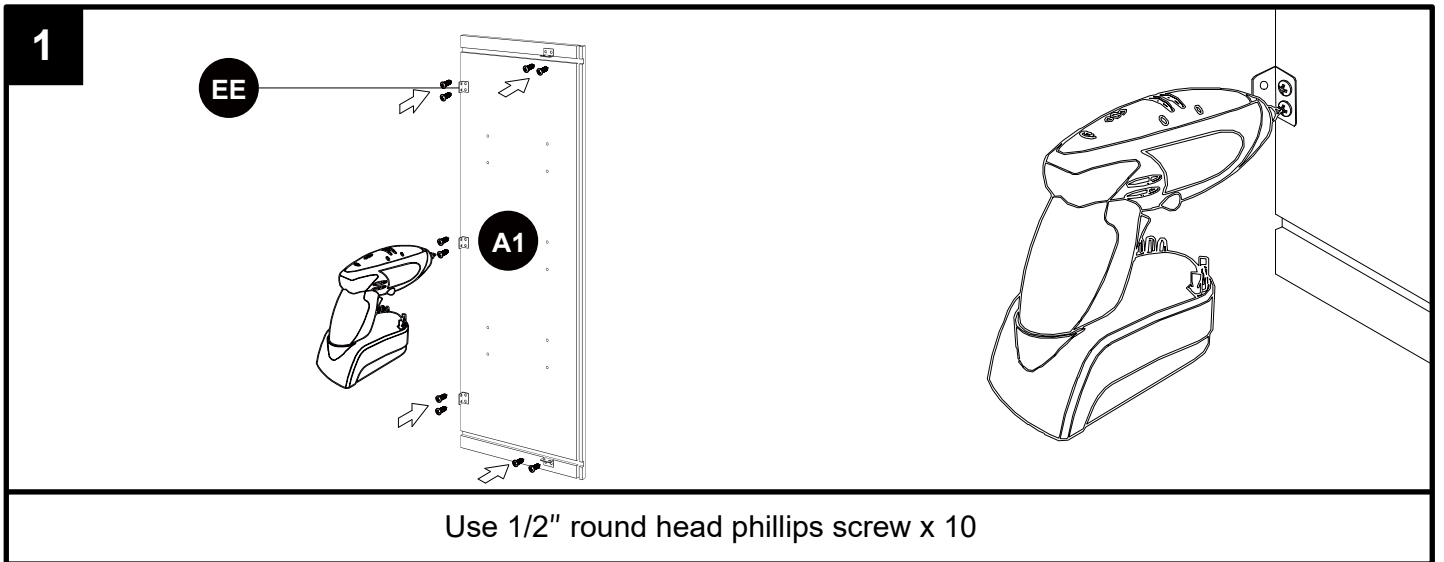

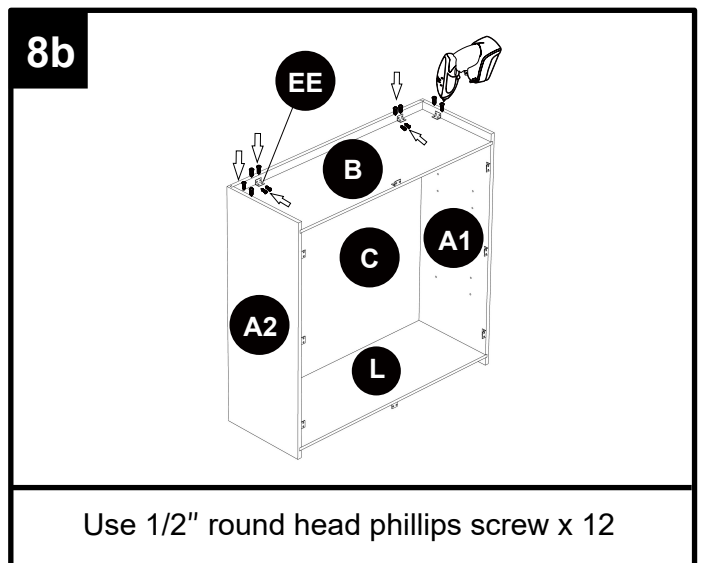
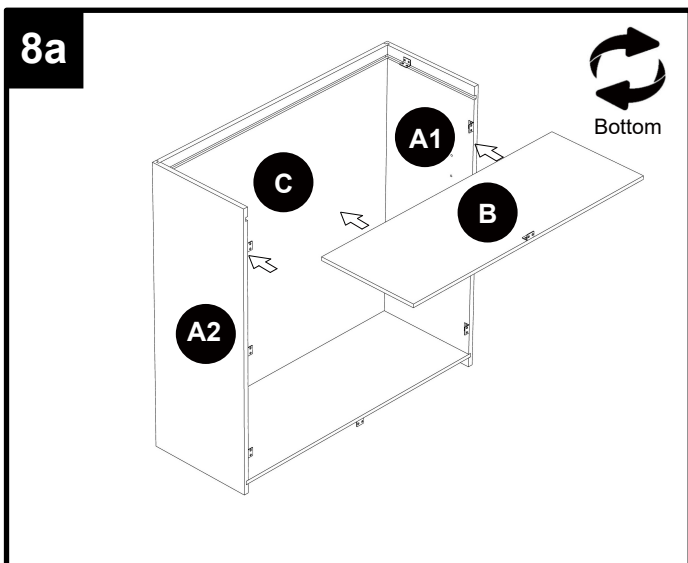
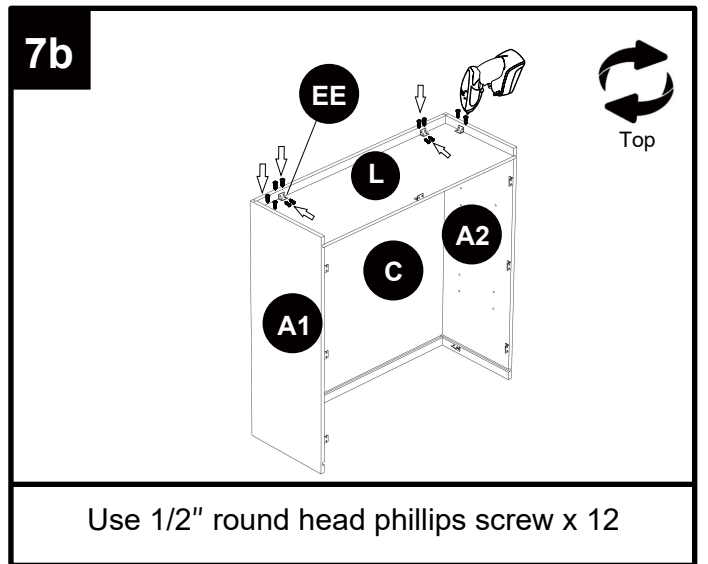
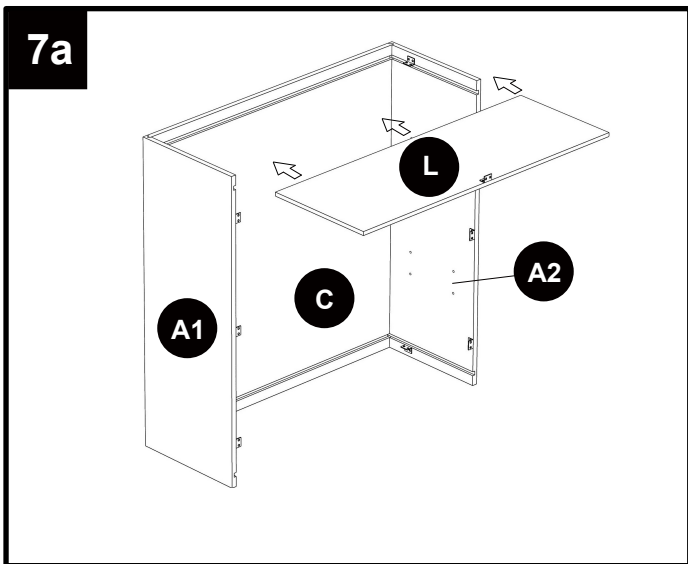
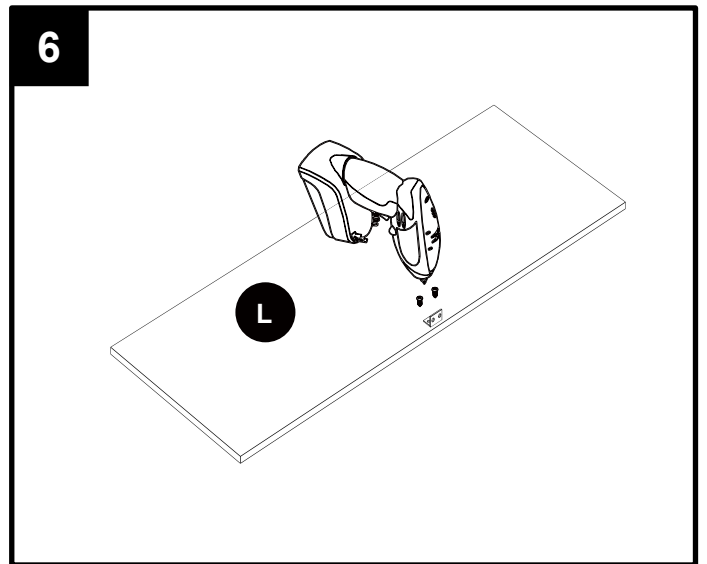
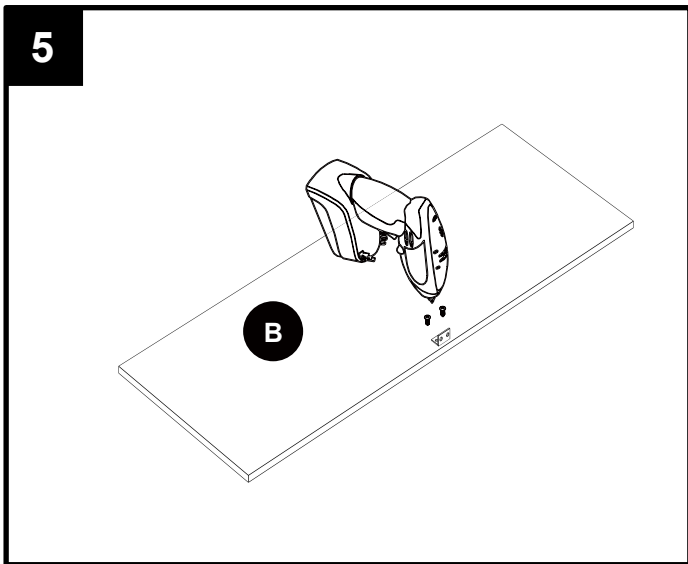

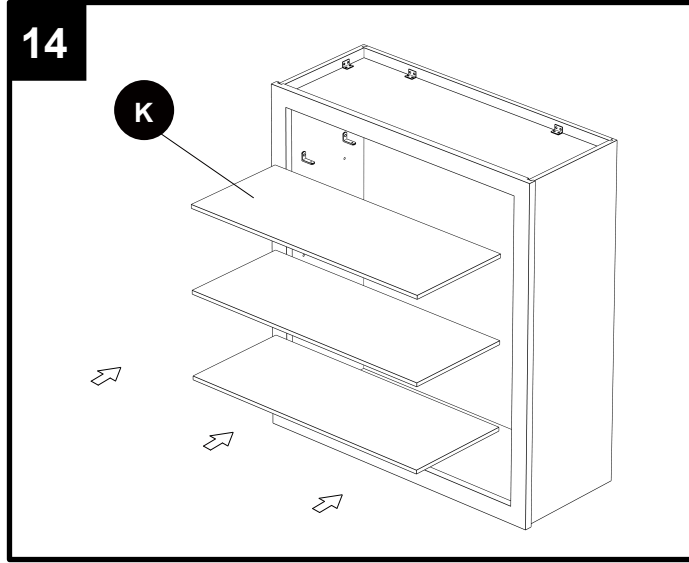
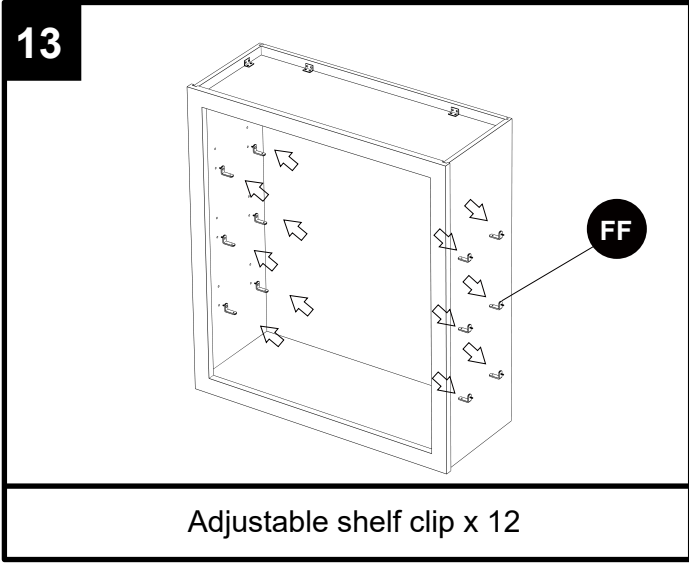
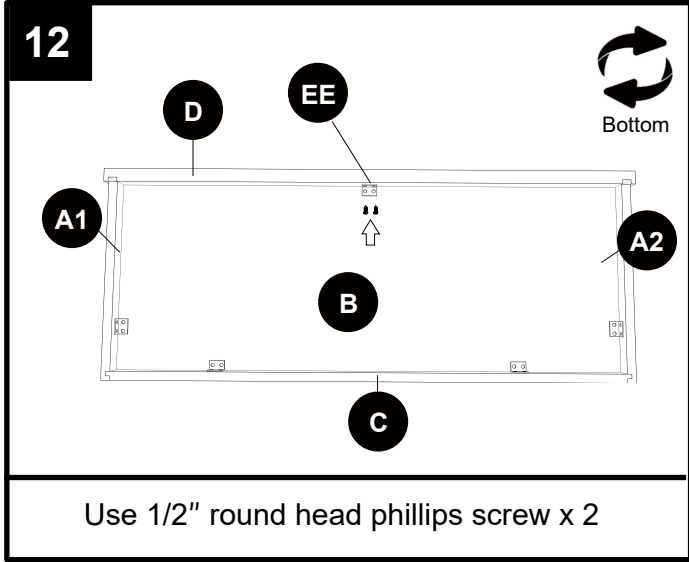
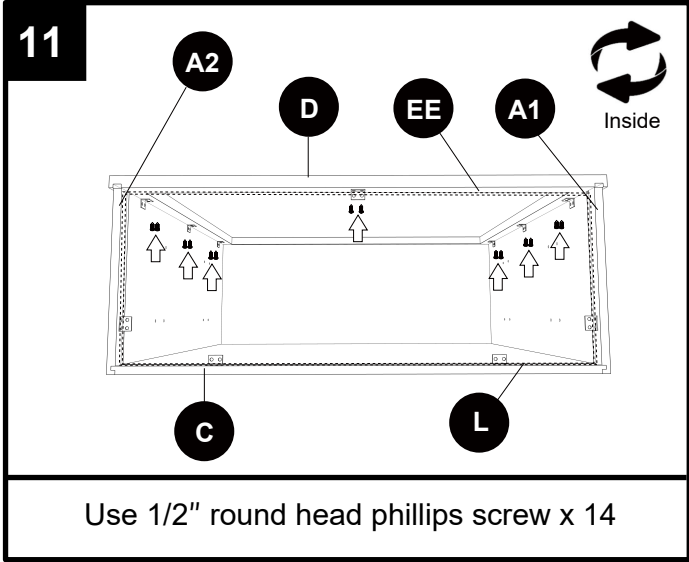
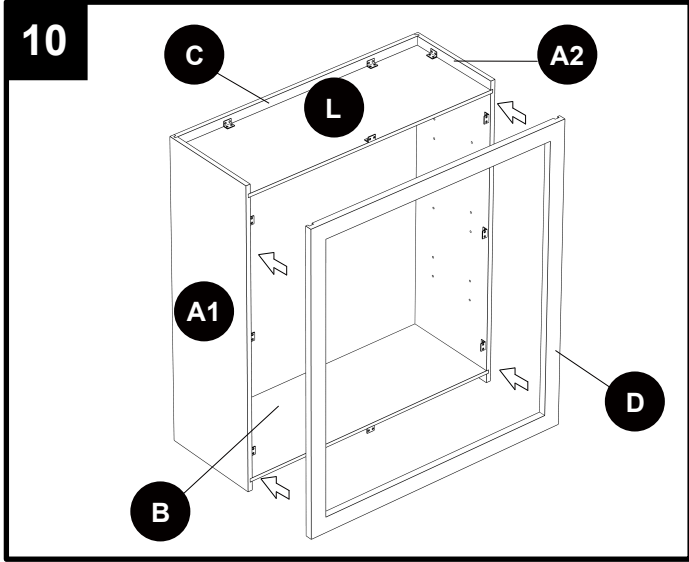
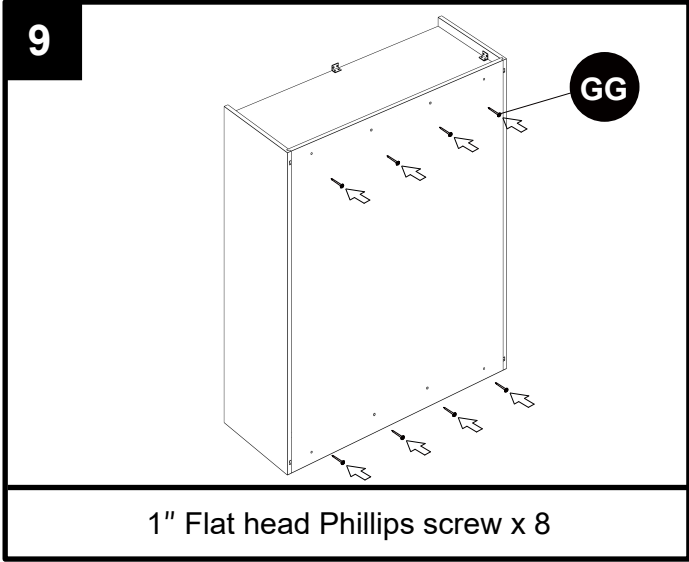

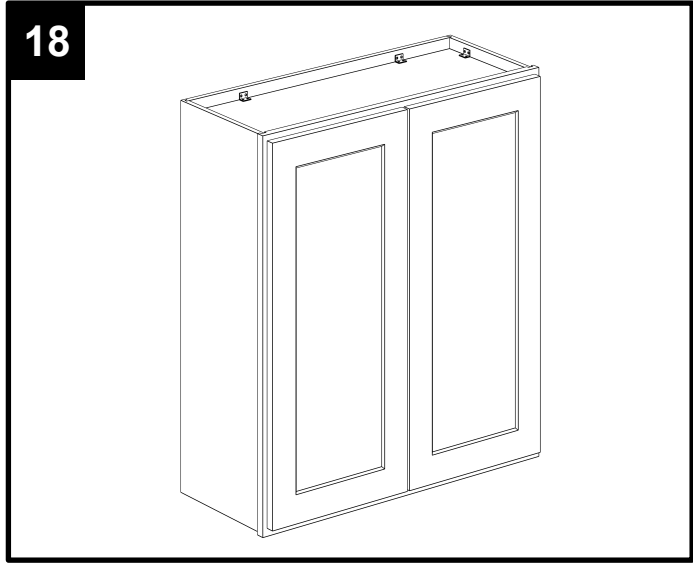
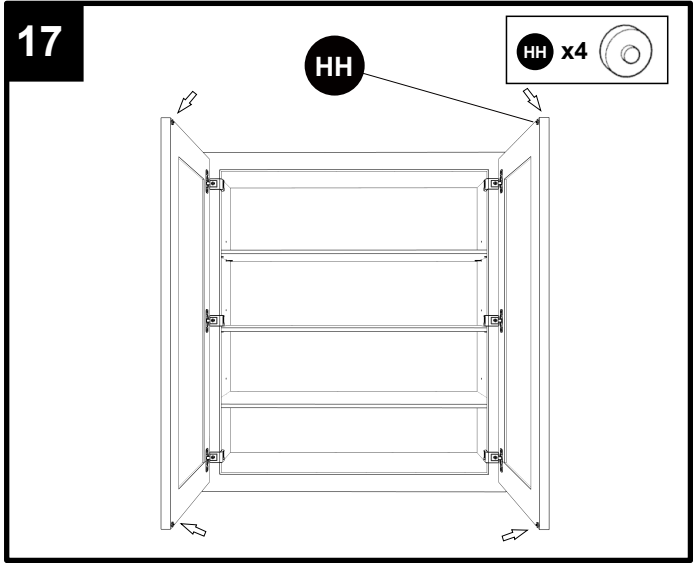
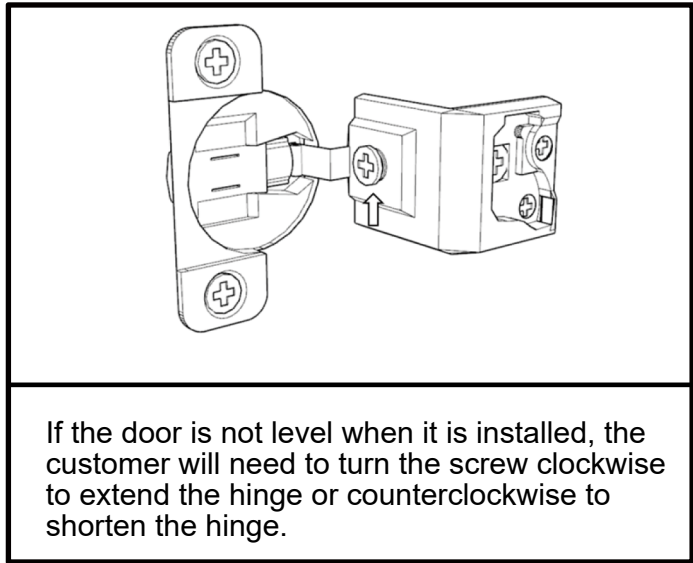
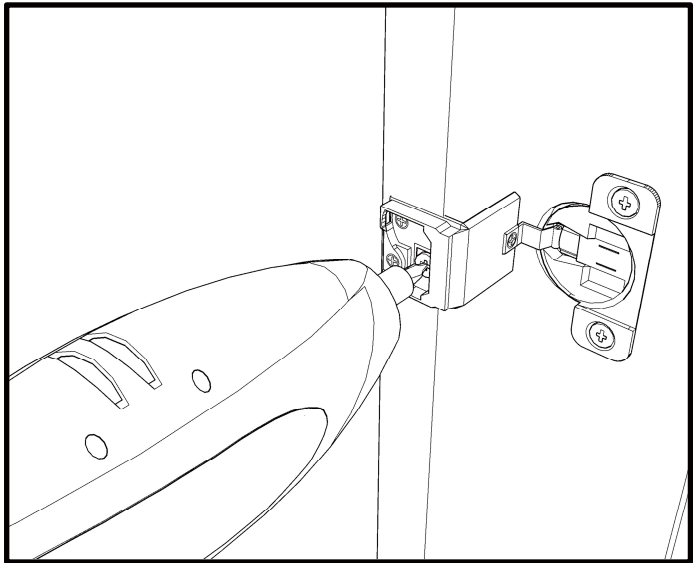
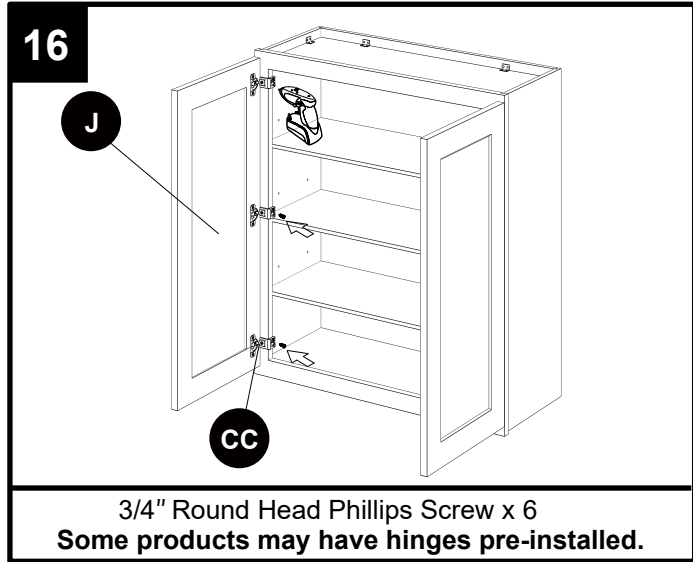
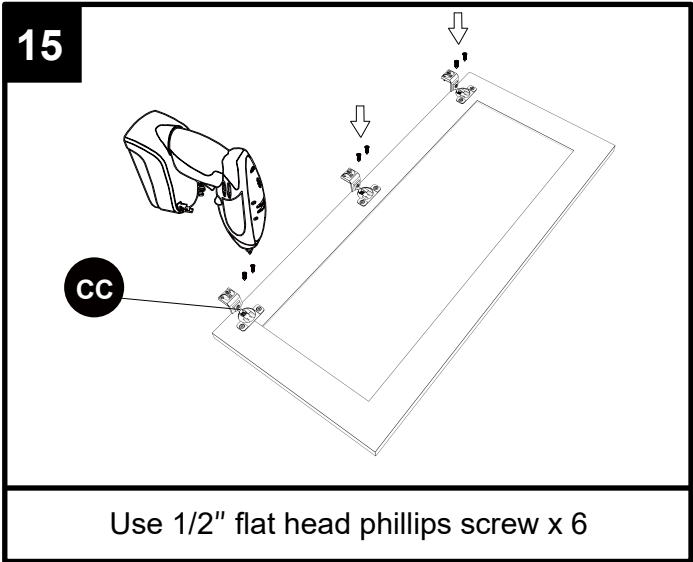

Dear customers,
Thank you for purchasing our product. If you require assistance, please contact the customer service team at the retailer where you purchased the product. The customer service team will be happy to assist you.