

- | | |
|------------------------------|------------------------------|
| (D) Montageanleitung | (GB) Assembly Instructions |
| (NL) Montagehandleiding | (PL) Instrukcja montażu |
| (TR) Montaj rehberi | (RUS) Руководство по монтажу |
| (E) Instrucciones de montaje | (F) Notice de montage |
| (I) Istruzioni di montaggio | (CZ) Návod k montáži |
| (SK) Návod na montáž | (RO) Instrucțiuni de montaj |
| (H) Szerelési útmutató | (SLO) Montaža |



- | | |
|--|--|
| (D) Sicherheits- und Gebrauchshinweise | (GB) Safety instructions and usage information |
| (NL) Veiligheids- en gebruiksrichtlijnen | (PL) Wskazówki dotyczące bezpieczeństwa i eksploatacji |
| (TR) Güvenlik ve Kullanım Talimatları | (RUS) Инструкции по безопасности и использованию |
| (E) Instrucciones de seguridad y uso | (F) Consignes de sécurité et d'utilisation |
| (I) Istruzioni di sicurezza e utilizzo | (CZ) Bezpečnostní pokyny a pokyny k použití |
| (SK) Bezpečnostné pokyny a pokyny pre používanie | (RO) Instrucțiuni de siguranță și utilizare |
| (H) Biztonsági és használati utasítások | (SLO) Varnostna opozorila in navodila za uporabo |



max.
115kg

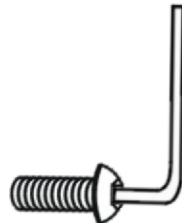

- | | |
|---|---------------------------------------|
| (D) Nach 5 Wochen nachziehen | (F) Resserrer après 5 semaines |
| (NL) Na 5 weken aandraaien | (I) Serrare dopo 5 settimane |
| (TR) 5 hafta sonra tekrar sıkın | (CZ) Po 5 týdnech dotáhněte |
| (GB) Retighten after 5 weeks | (SK) Po 5 týždňoch dotiahnuť |
| (PL) Dokręcić po 5 tygodniach | (RO) Strângeți după 5 săptămâni |
| (RUS) Через 5 недель подтянуть | (H) 5 hét elteltével utána kell húzni |
| (SLO) Vijake je treba po petih tednih priviti | (E) Reapretar después de 5 semanas |

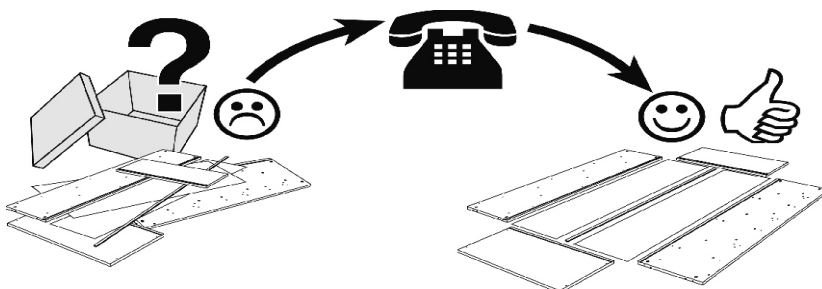
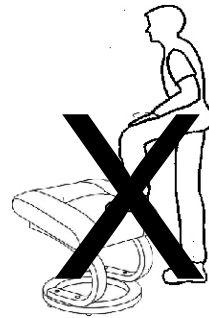

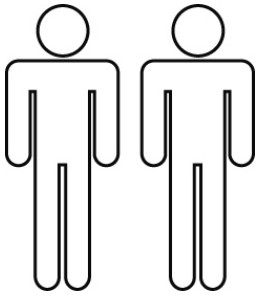

1

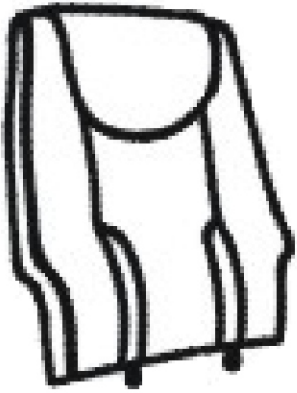

2

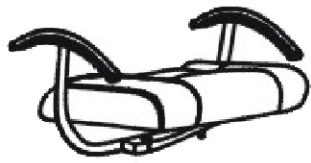

3



4



5



6



7



8



(9) 4x



6x20mm

(10) 4x



6x35mm

(11) 2x



8x50mm

(12) 8x



6mm

(13) 2x



(14) 1x



(15) 2x

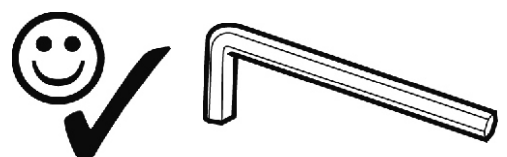
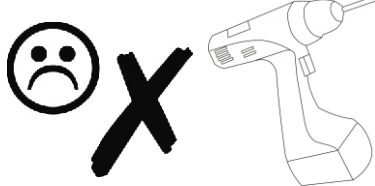

1

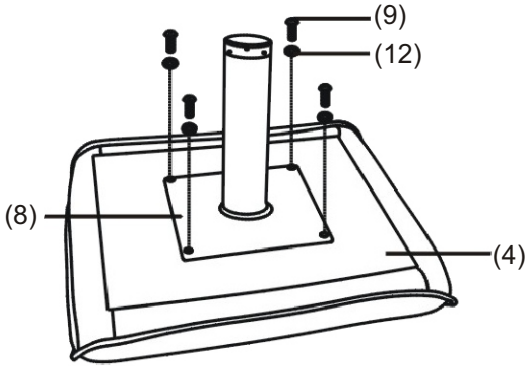
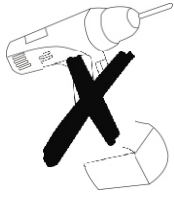

2

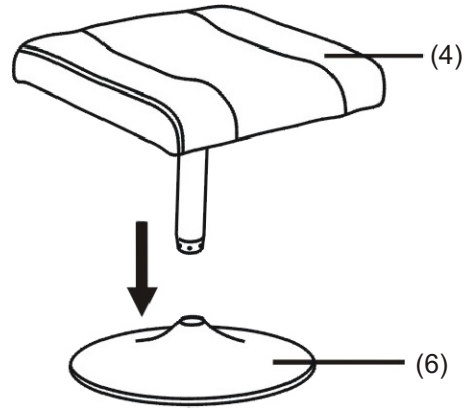

3

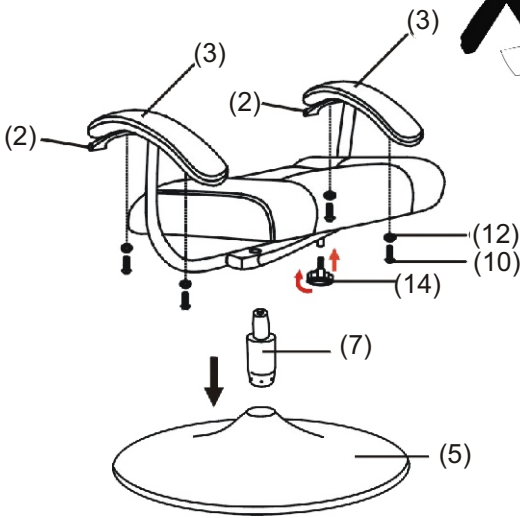
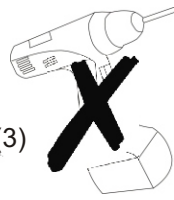

4

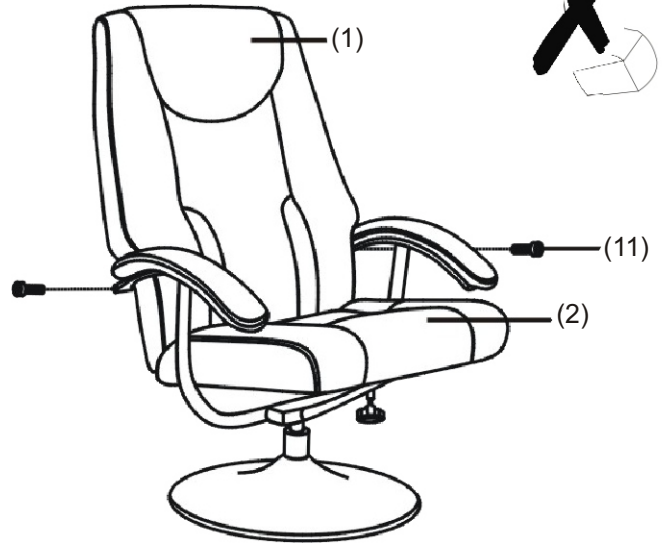
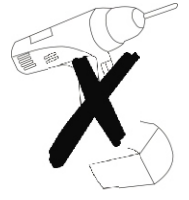

5



2x (13)

