

Assembly Instruction

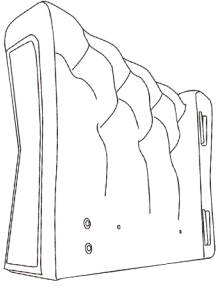

A:left armrestx1pcs

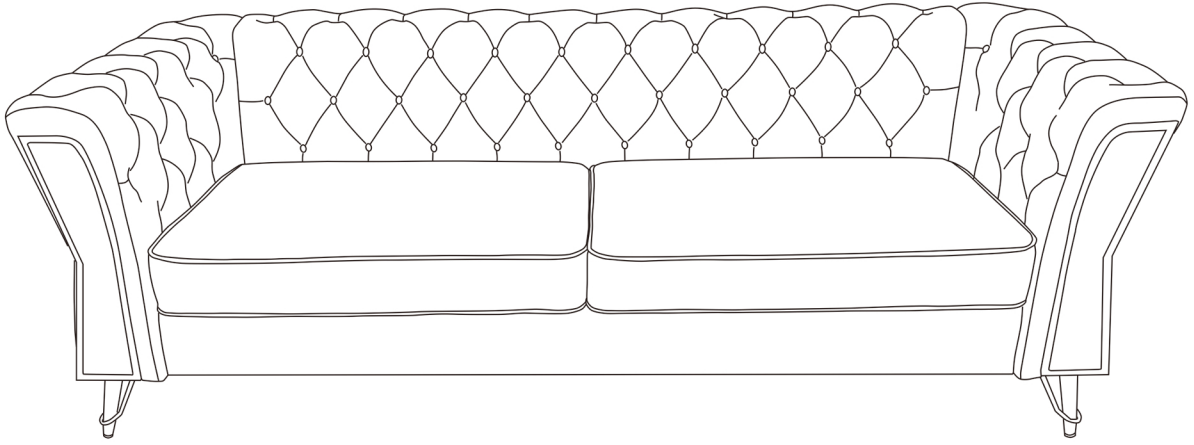
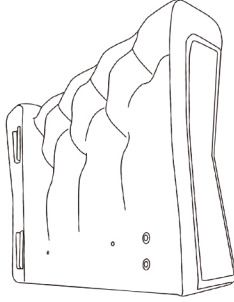

B:right armrestx1pcs

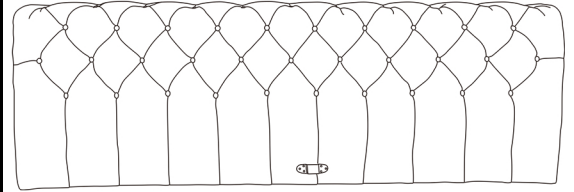

C:sofa backrest x1pcs

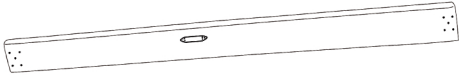

D:front board x1pcs

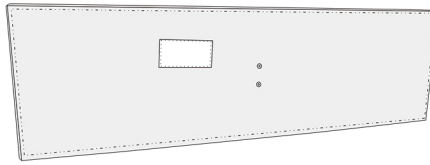

E:bottom board x1pcs

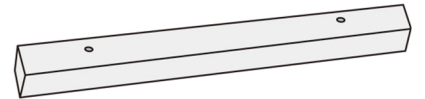

F:side bar x2pcs

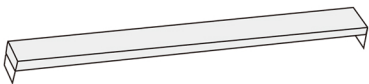

G:center bar x1pcs

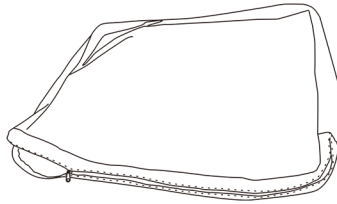

H:seat cushion cover x2pcs



I:seat cushion x2pcs

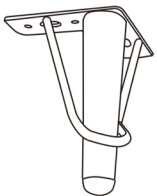

J:legs x4pcs

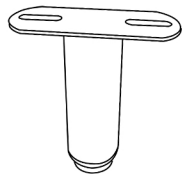

K:mid leg x1pcs



L:angle bracket(R) x1pcs



M: angle bracket(L) x1pcs



N:M6x70MM x4pcs



O: M6x20MM x20pcs



P:washerx14pcs



Q:hex key x1pcs

Step 1 Insert the backrest to each armrest.

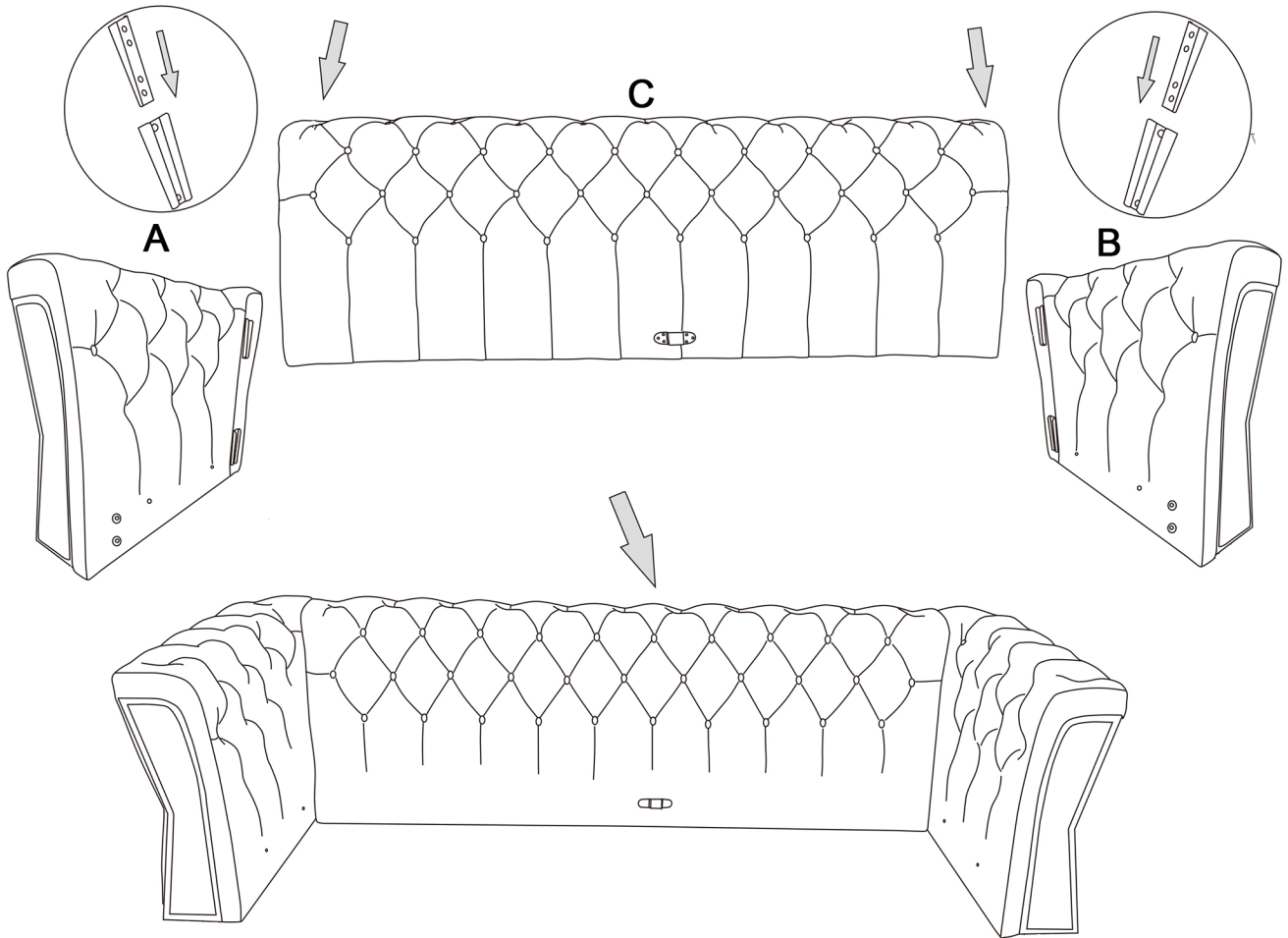

Step 2. Install the angle brackets to both side of the front board.

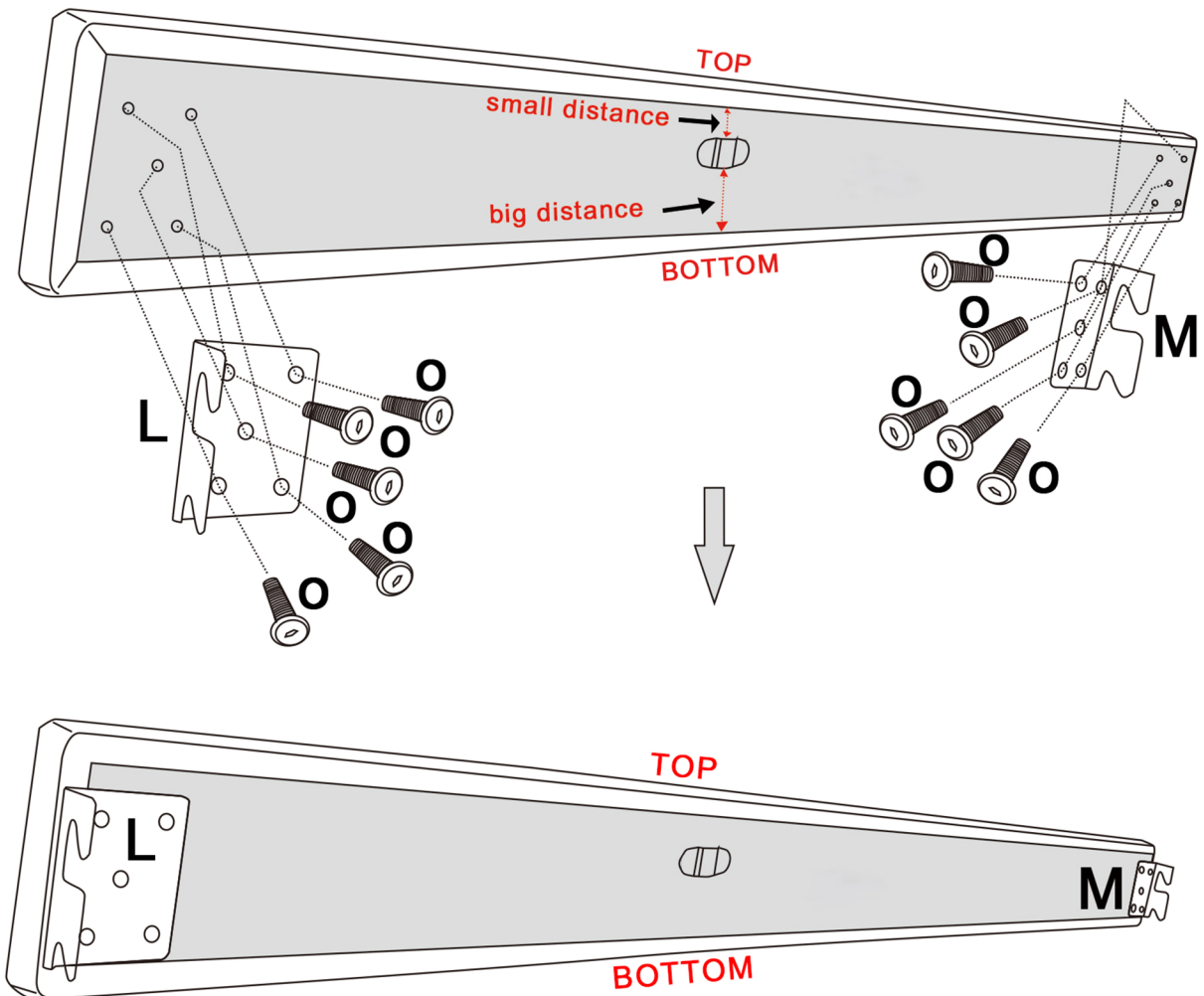

Step 3. Install the front board and fasten to both armrest.

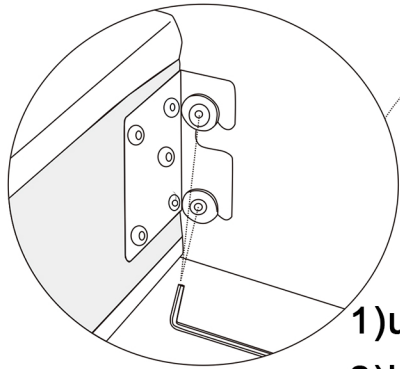
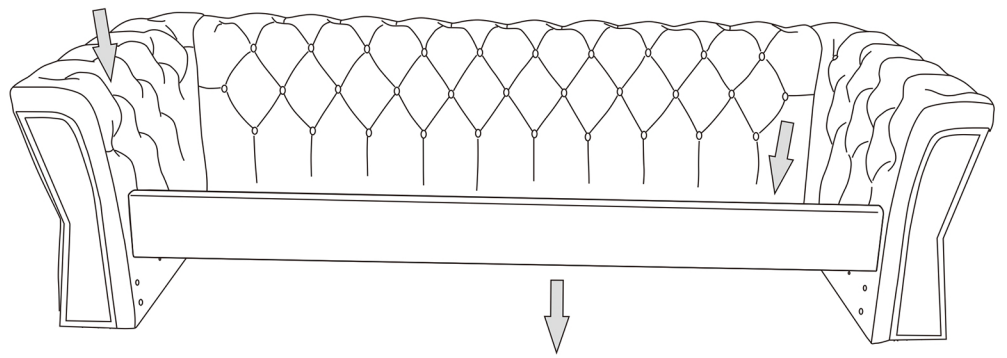

- 1)unscrew the bolt 50%
- 2)both brackets hook on the bolts
- 3)tighten the bolts

Step 4. Install the side bar on each armrest.

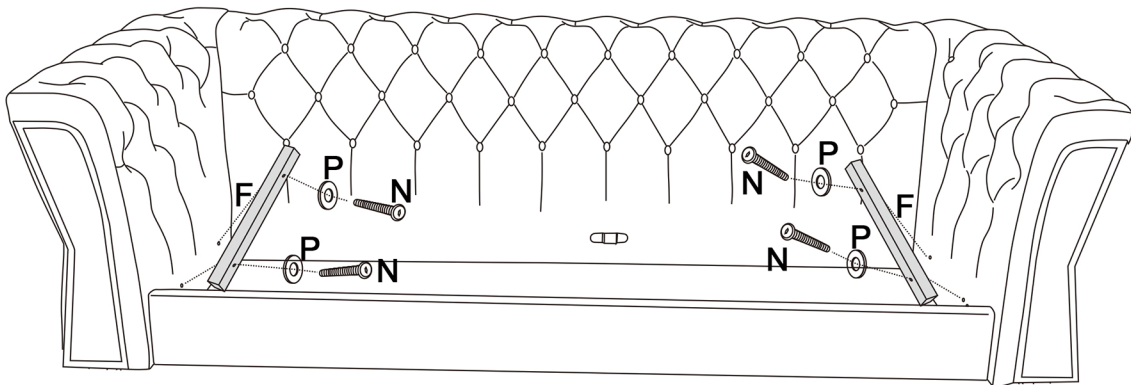

Step 5. Install the mid bar.

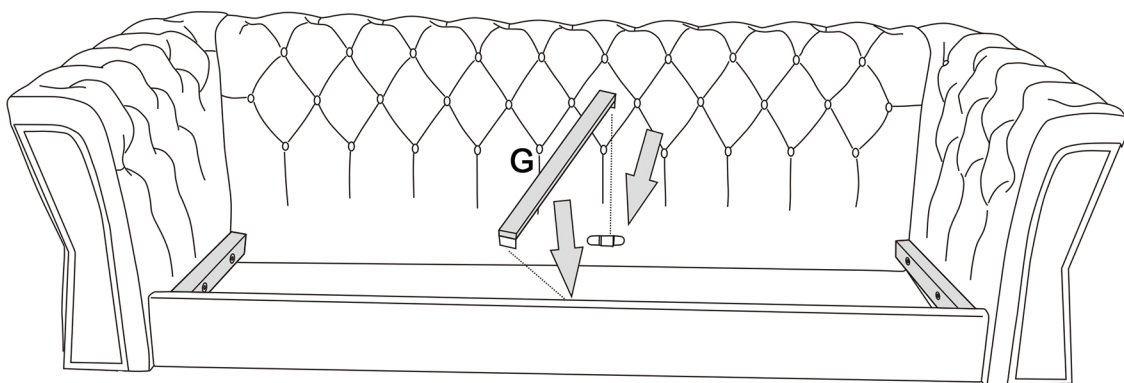

Step 6. Install the bottom board as following.

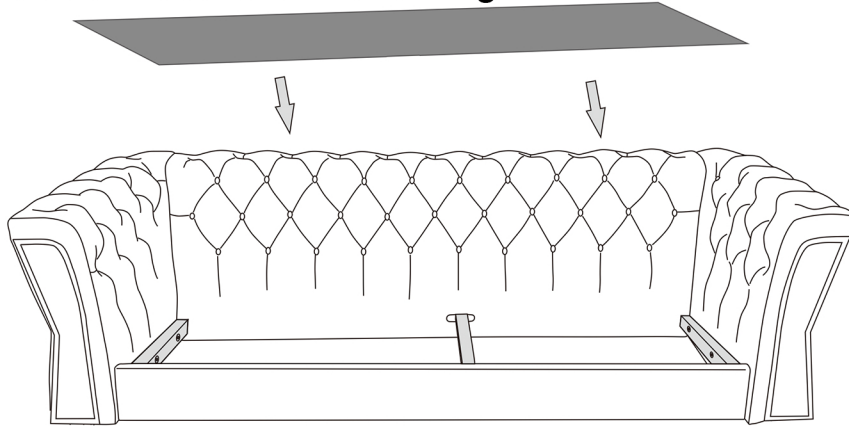

Step 7. Install the seat cushions.

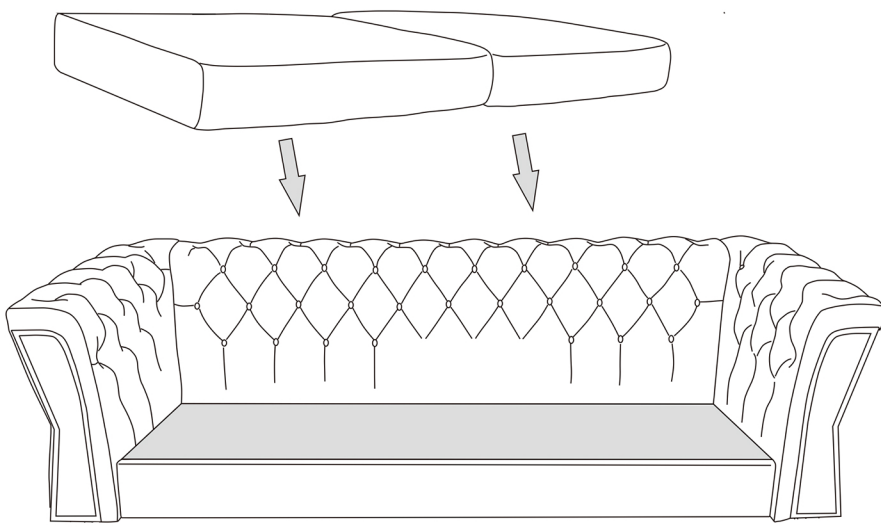

Step 8. Install the mid leg and 4 pcs legs under the sofa.

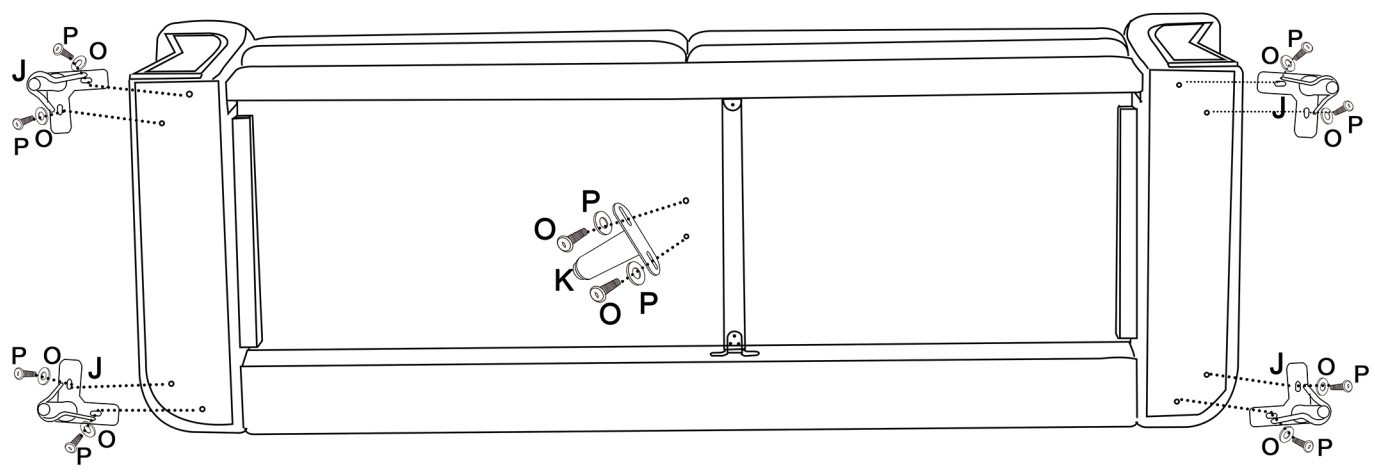

Finish

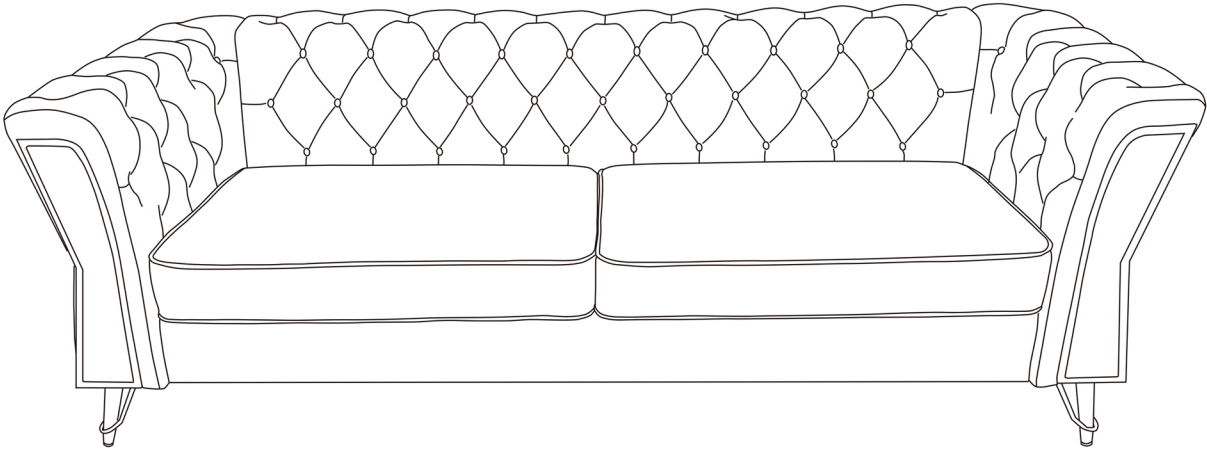

How to install the cushions

Step 1. Open the plastic bag and remove the cushions foam.

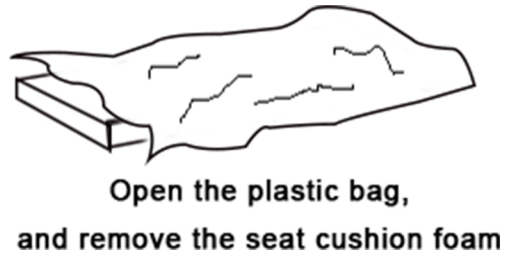
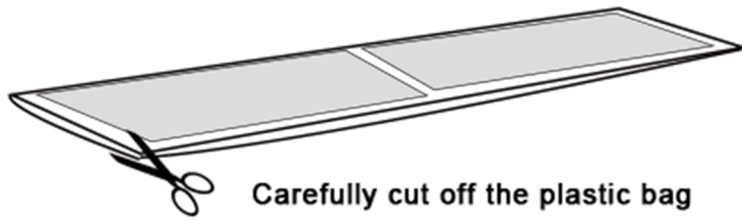

Step 2. Cover the fabric covers to all cushions foam. When you get the foam, you will see the RED words which side is the **top**, **front** and **back** as following.

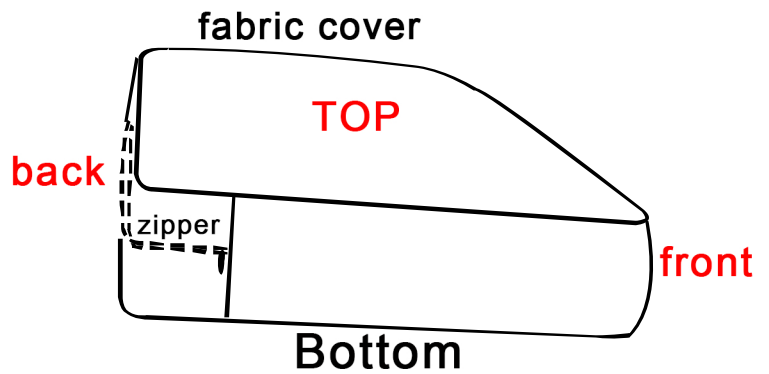
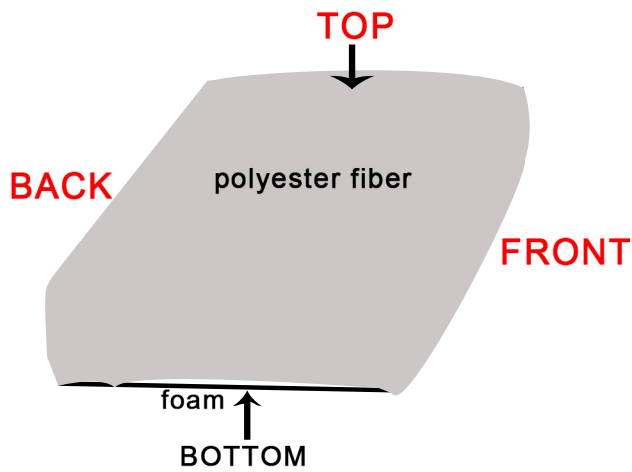

How to tidy sofa seat cushion?



At the beginning all cushions are a little loose which is normal. Please allow at least 72 hours for all cushions foam to recover to its natural state after covering the fabric covers.