

# ASSEMBLY INSTRUCTIONS

ITEM NO. : F8795 F8798

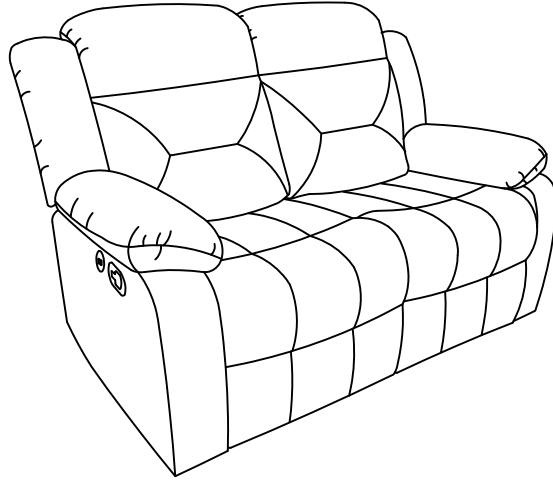

## PARTS LIST

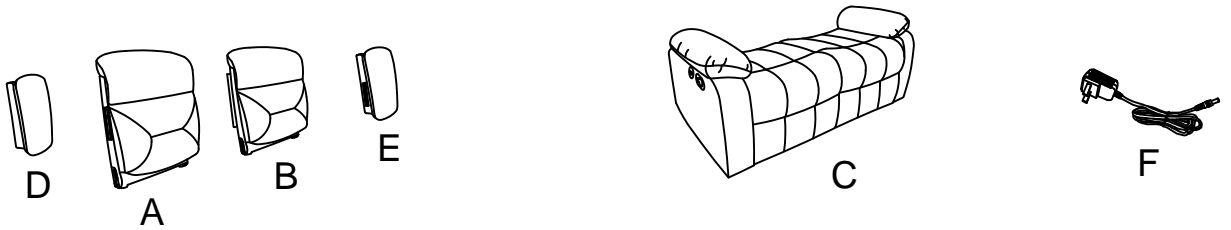

## ATTENTION

### Fragile Spots :

Be careful , do not grip at fragile spots where they can be **damaged** easily .

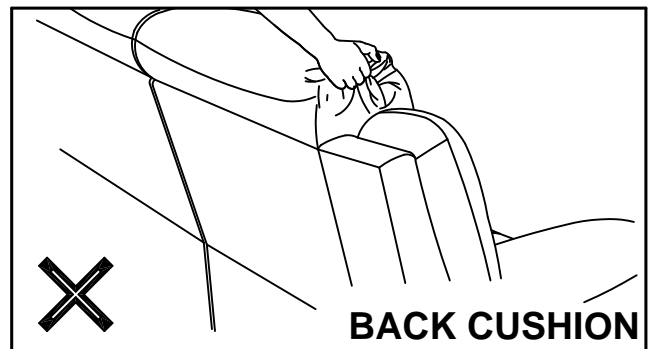
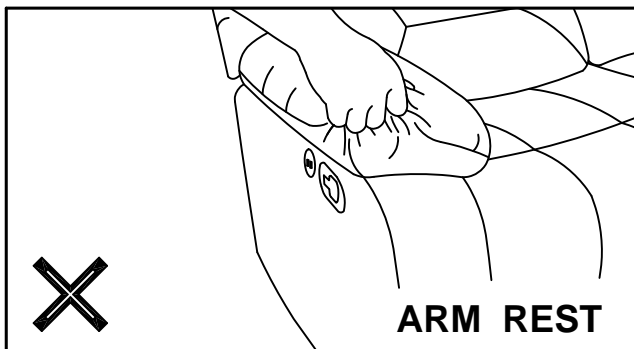

### Moving .....

Hold the side and bottom of sofa while moving .

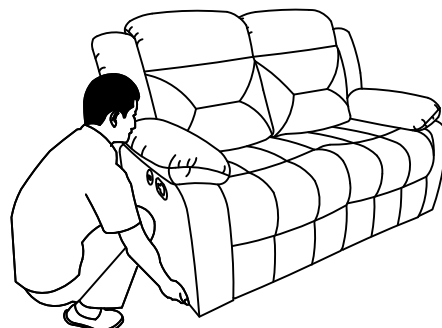

# How to assemble:

## STEP 1:

**Note :** Match both side metal bracket , push down back cushion to assemble .

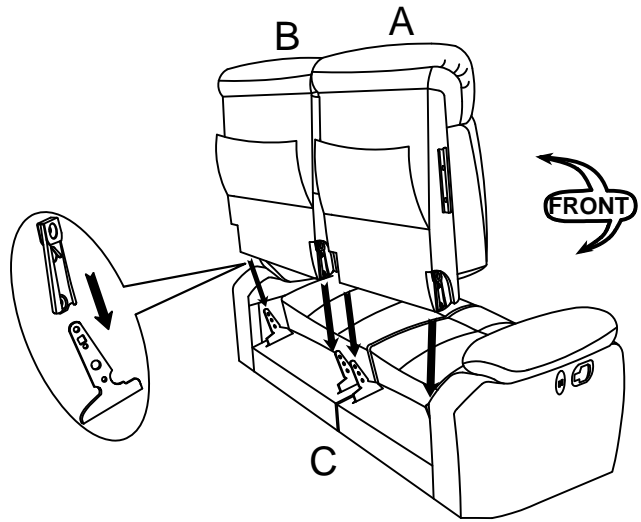

## STEP 2:

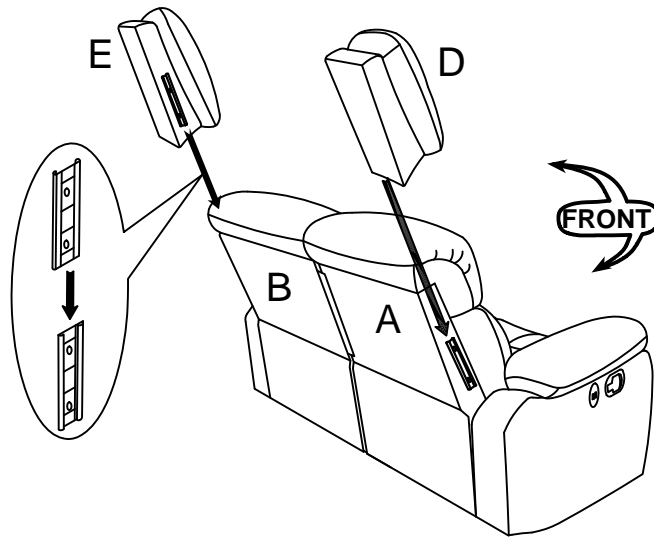

## STEP 3:

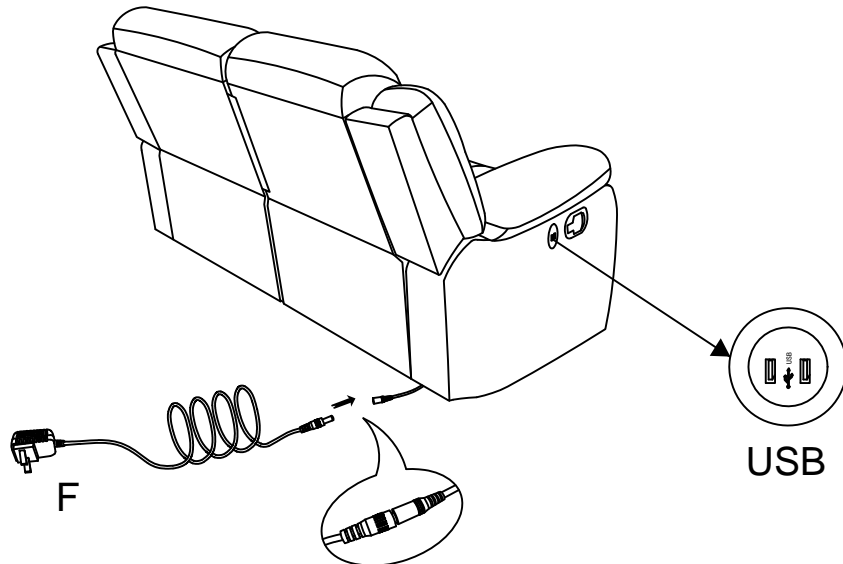

# PRE-ASSEMBLY TIPS

We get it - building furniture isn't always easy! But have no fear, helpful hints are here. Our assembly tips and tricks will have you enjoying that new furniture in no time. Let's get construction ready to rock!

## TEAM ASSEMBLY

Have at least 2 people put the product together to prevent injury and damage.



## ASSEMBLE IN PLACE

Put together near the intended location to avoid moving later.

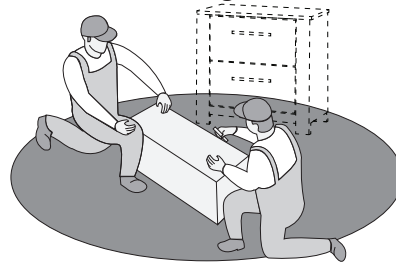
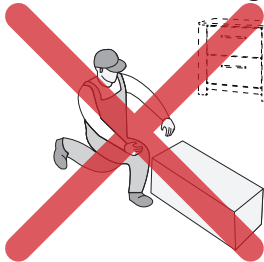

## CLEAR WORKSPACE

Ensure ample room to maneuver during assembly.



## AVOID SCRATCHES

Assemble on cardboard, blankets, or carpet to prevent scratches.



## FLAT SURFACE

Place on a level surface with furniture legs evenly contacting the floor.



# ASSEMBLY SAFETY STEPS



FAILURE TO FOLLOW THE GUIDELINES BELOW MAY RESULT IN INJURY AND/OR PROPERTY DAMAGE.

**1**

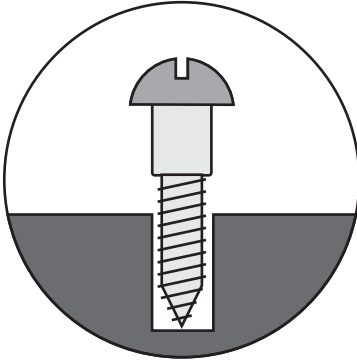

## POSITIONING

Insert all hardware and parts in the correct holes.

**2**

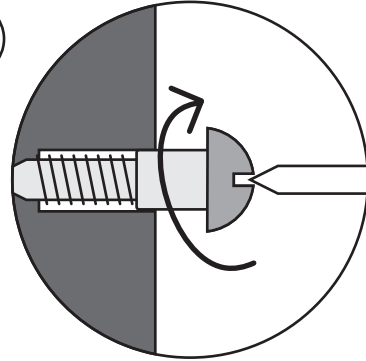

## TIGHTENING

Only tighten bolts when the step is fully completed.

**3**

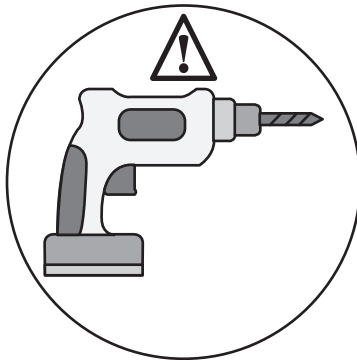

## TOOLS

Use hand tools unless the manual specifies power tools.

**4**

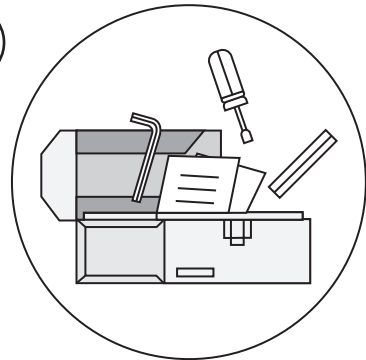

## INSTRUCTIONS

Keep the manual and tools for future maintenance needs.

**5**

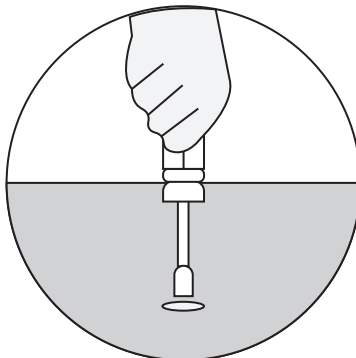

## MAINTENANCE

Check for loose joints after 2 weeks and re-tighten every 6 months.

## DISCLAIMER:

It is the user's responsibility to properly maintain the furniture over its lifetime. Hardware such as screws, bolts, and other fasteners may naturally loosen over time with normal use of the product. This can lead to instability if the furniture is unable to adequately support the intended weight capacity. To prevent injuries, following the maintenance instructions is key to ensuring product safety and longevity.