

Instruction manual

CORNER SOFA

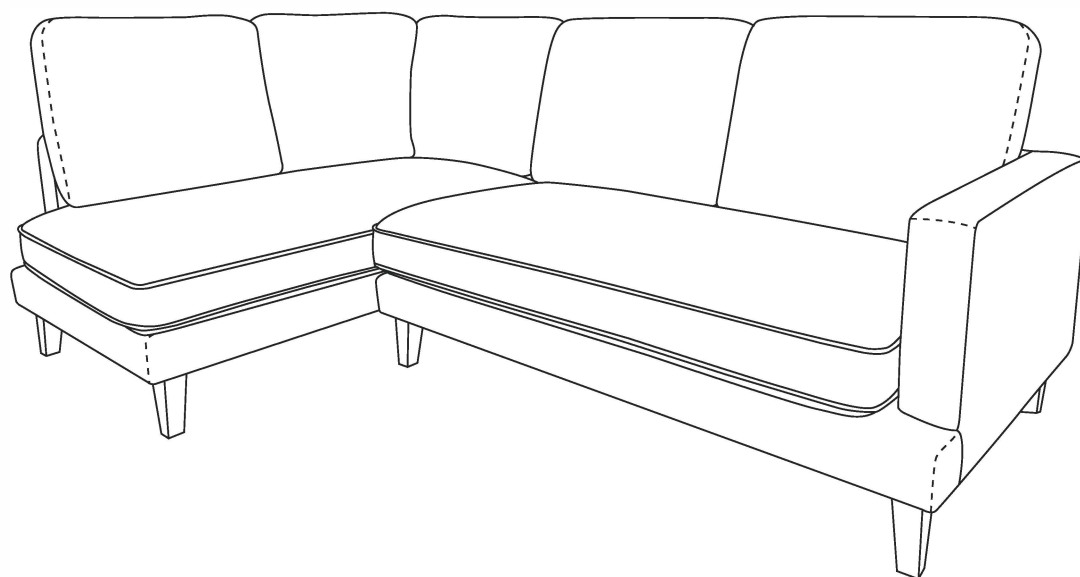

CONTENTS

Safety and care advice	1
Components	2
Assembly instructions	4
Copyright	6

⚠ SAFETY AND CARE ADVICE ⚠

PLEASE READ THESE INSTRUCTIONS CAREFULLY AND KEEP FOR FUTURE REFERENCE

- **Warning:** Please lift with care.
- Check you have all the components and tools listed on pages 2 and 3.
- Remove all fittings from the plastic bags and separate them into their groups.
- Keep children and animals away from the work area, small parts could choke if swallowed.
- Make sure you have enough space to lay out the parts before starting.
- Do not stand or put weight on the product, this could cause damage.
- Assemble the item as close to its final position (in the same room) as possible.
- Assemble on a soft level surface to avoid damaging the unit or your floor (use opened out unit carton).



- We do not recommend the use of power drill/drivers **for inserting screws**, as this could damage the unit. Only use hand screwdrivers.
- Dispose of all packaging carefully and responsibly.

CARE AND MAINTENANCE

- Only clean using a damp cloth and mild detergent, do not use bleach or abrasive cleaners.
- From time to time check that there are no loose screws on this unit.
- This product should not be discarded with household waste. Take to your local authority waste disposal center.

Note *If required the next page can be cut out and used as reference throughout the assembly. Keep this page with these instructions for future reference.*

COMPONENTS

Please check you have all the panels listed below:

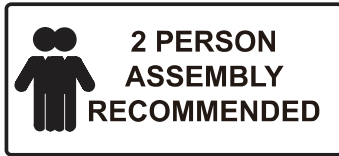

1

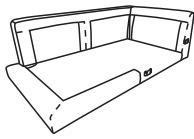

x1

2

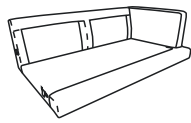

x1

3



x1

4



x1

5

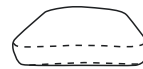

x1

6



x1

7

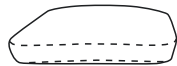

x1

8



x2

9



x4

10



x4

1 Seat frame (chaise)	x1	6 Back cushion B (chaise)	x1
2 Seat frame (2 seater)	x1	7 Back cushion C (chaise)	x1
3 Cushion(2 seater)	x1	8 Back cushion (2 seater)	x2
4 Cushion(chaise)	x1	9 Legs A	x4
5 Back cushion A (chaise)	x1	10 Legs B	x4



COMPONENTS

Please check you have all the fittings listed below:

A x32

M8*30

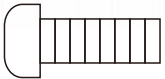

B x1

M6

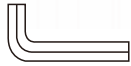

Alley M6

C x8





Felt pad



ASSEMBLY INSTRUCTIONS

Step 1

A		x32
B		x1
C		x8

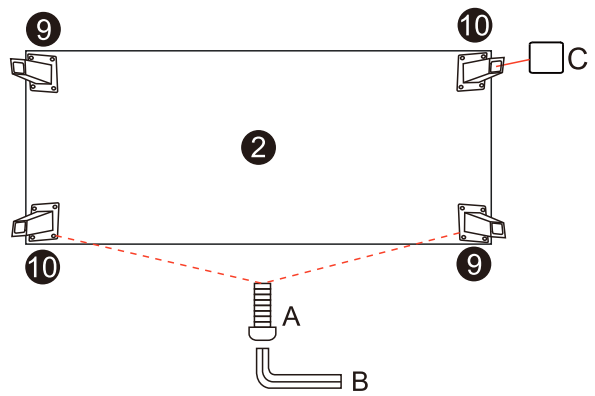
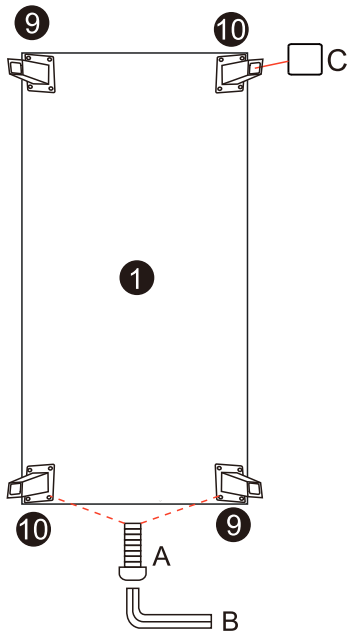

Step 2

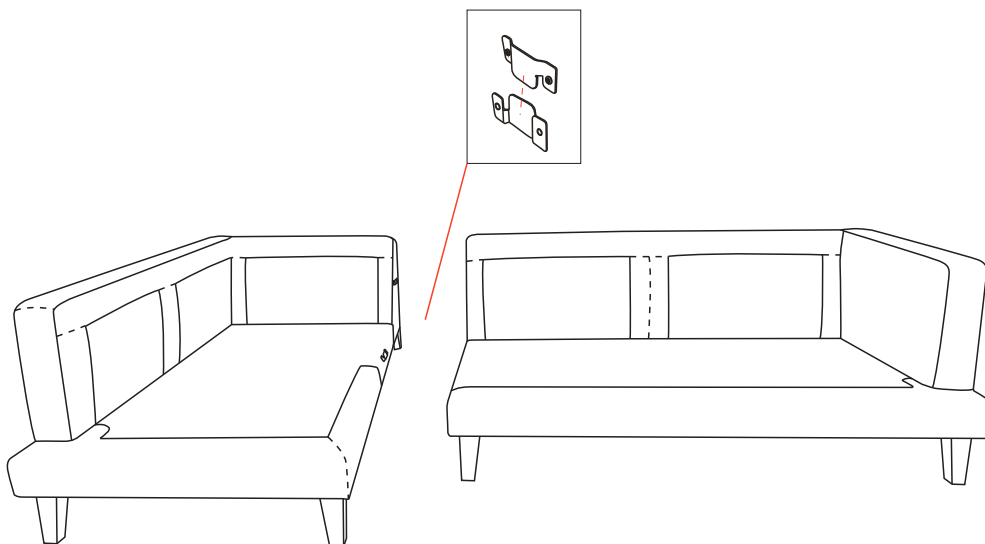

ASSEMBLY INSTRUCTIONS

Step 3

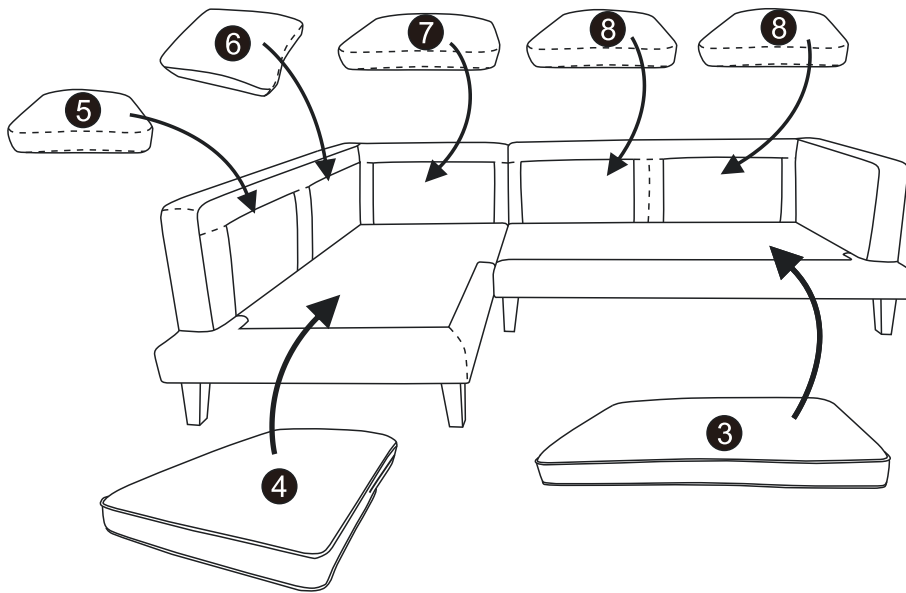

Step 4

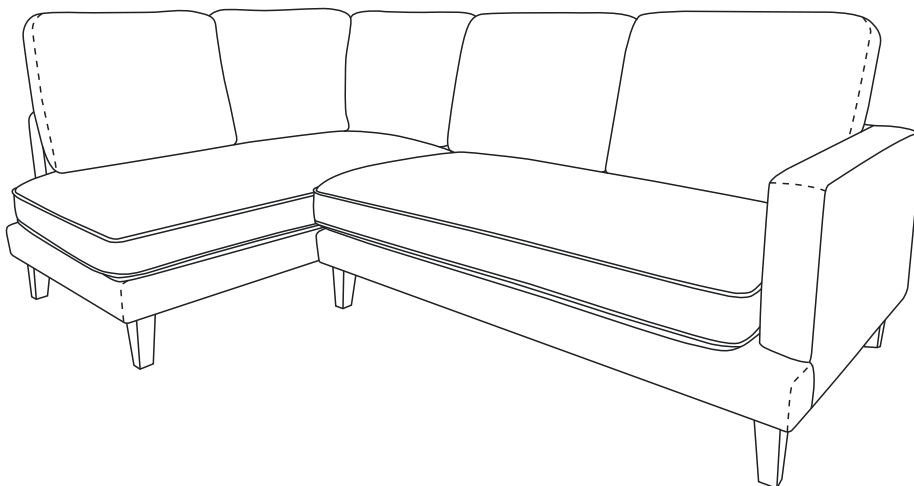

IF YOU FIND A DEFECTIVE PART

We fully stock all parts and components. Any defective part can be quickly replaced. Take note of the defective part number in manual and we will arrange a replacement.

You can email our team.

COPYRIGHT

All material in this instruction manual is copyrighted.

Any unauthorised use may violate worldwide copyright, trademark and other laws.