











# Assembly Instructions

Caution : You must read this before you proceed





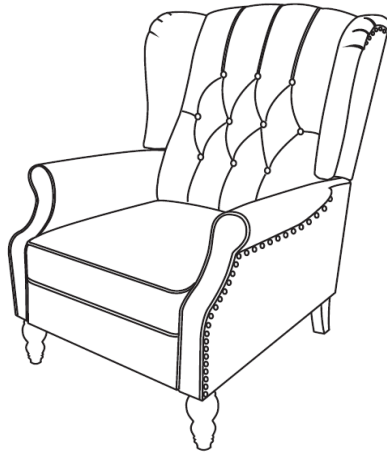

## Care & Maintenance

- ⊘ 
    - Not for commercial use. For residential use only.
  - ✓ 
    - Furniture may scratch floors. We recommend using furniture pads to protect your floors.
  - ⊘ 
    - Do not put hot items directly on furniture surface.
  - ⊘ 
    - Do not clean furniture with harsh cleansers or polish.
  - ⊘ 
    - Do not place furniture under direct sunlight.
  - ⊘ 
    - Do not place furniture near heating or cooling vents.
  - ⊘ 
    - Do not write on furniture without a padded barrier to protect the surface.
  - ⊘ 
    - Do not place furniture outside . For indoor use only.
  - ⊘ 
    - Stains may be removed with mild soap solution and damp cloth.
  - ⊘ 
    - Children should not climb or jump on the furniture.
- 
- ✓ 
    - Dust and pick-up spills using a clean, non-colored, lint-free cloth.



# Recliner Chair



## Parts List

Label	Picture	Description	QTY
A		Chair Backrest	1
B1		Right Wing	1
B2		Left Wing	1
C		Chair Base	1
D		Front Leg	2
E1		Right Hind Leg	1
E2		Left Hind Leg	1

## Hardware

Label	Picture	Description	QTY
①		Plastic Washer	3
②		Washer (M8)	7
③		Washer (M6)	3
④		Washer Ring	7
⑤		Bolt (M8*25mm)	7
⑥		Bolt (M6*40mm)	3
⑦		Allen Wrench(M6)	1
⑧		Allen Wrench(M8)	1

## Assembly Preparation

Before Beginning Assembly:

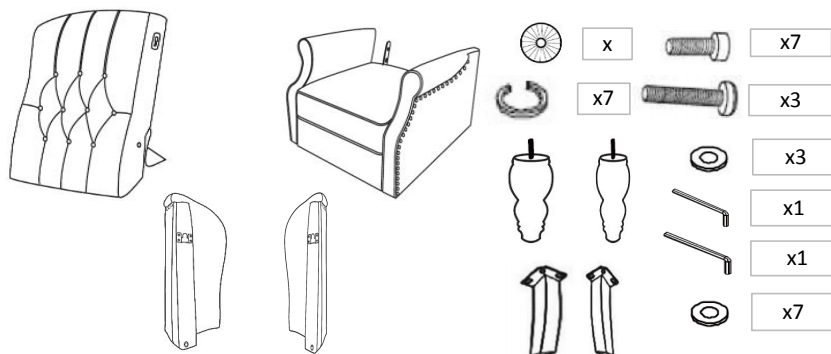

- Read instructions, cover to cover-



- Have 2 adults on hand for assembly-



- Do not assemble on flooring or carpet-



- Assemble on a clean non-marring surface (packing foam)-



- Save all packaging until finished-

# Assembly Steps

## OVERVIEW

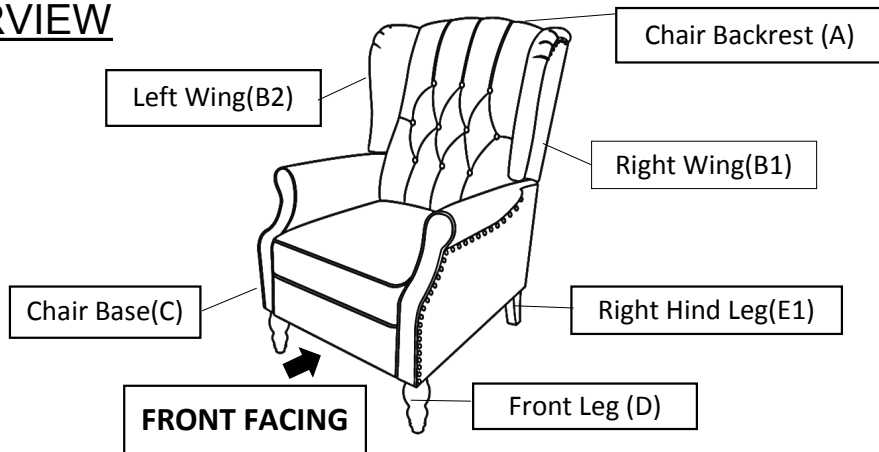

This Recliner Chair has multiple parts and may require up to some 30 minutes to assemble. To give you an overview of the Recliner Chair parts, the above picture is to help you put the various parts into perspective. Please read through the instructions herebelow to familiarise the parts and steps before assembly.

### Step 1

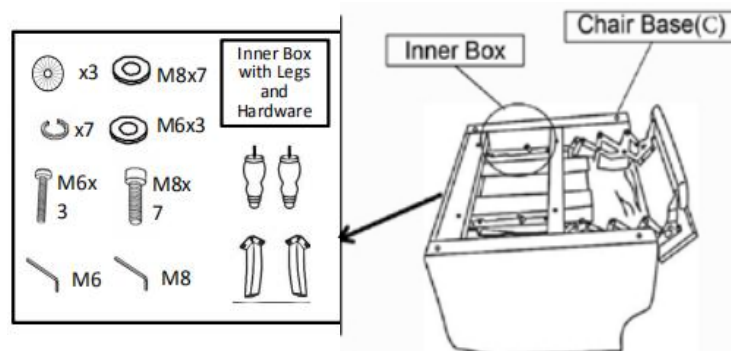

Place the Chair Base (C) facedown on a clean, non-marring surface. Take out the four wooden legs and Hardware from inner box, as picture shown on above.

### Step 2

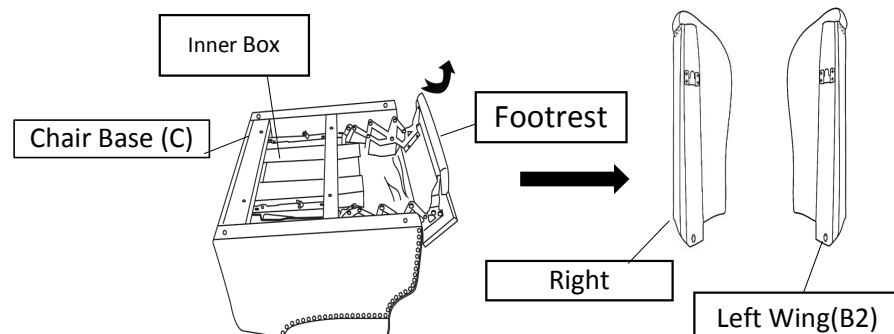

Then, turn the Chair Base(C) upside down on a clean, non-marring surface. Extend the Footrest to open. Carefully take out inner box stowed as shown above. Open it and you will find Right Wings (B1) & Left Wing(B2). Stow the Footrest to original position.

**Step 3**

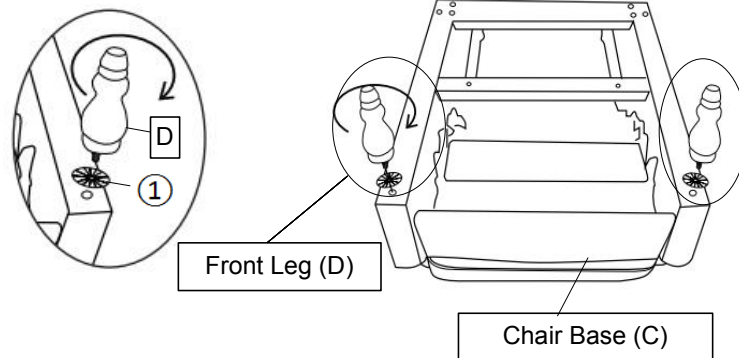

Position the Chair Base(C) on its back, as shown above. Attach the Front Leg(D) to Chair Base(C) with Plastic Washer(1) by turning the legs clockwise as shown. Repeat the same step to install the remaining Front Leg(D). Note: The use of Plastic Washer(1) are OPTIONAL and are especially useful to help alleviate slight wobbleness. Some Legs may need more than one Plastic Washer(1) whilst some Legs may not need any .

**Step 4**

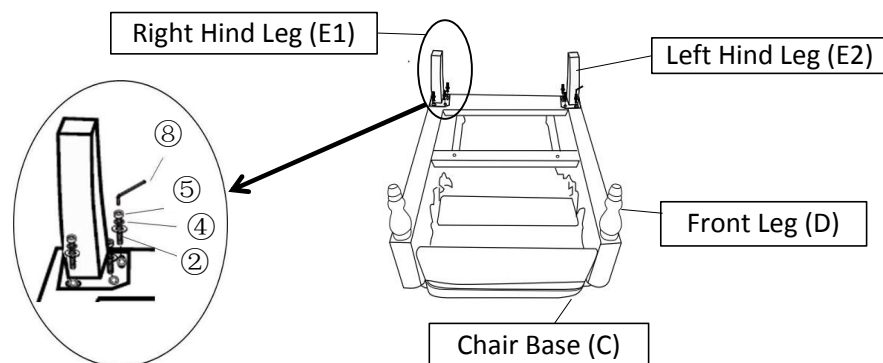

Attach the Right Hind Leg(E1) and Left Hind Leg(E2) to Chair Base(C) use Bolt(5) ,Washer Ring(4),Washer(2) with Allen Wrench(8)by turning the legs clockwise as shown.

**Step 5**

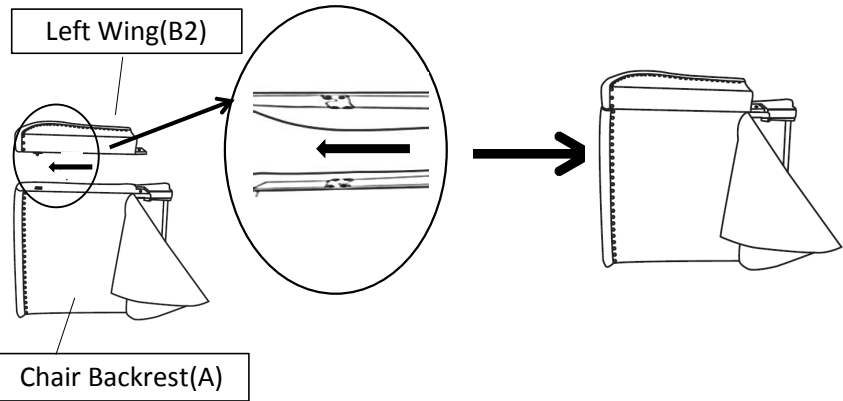

Position the Chair Backrest(A) on it's right side.  
Align the mounting positions of the Left Wing(B2) with left side of Chair Backrest (A). Then slide Left Wing(B2) forward by hand to make sure it locks into the position as shown in the picture.

**Step 6**

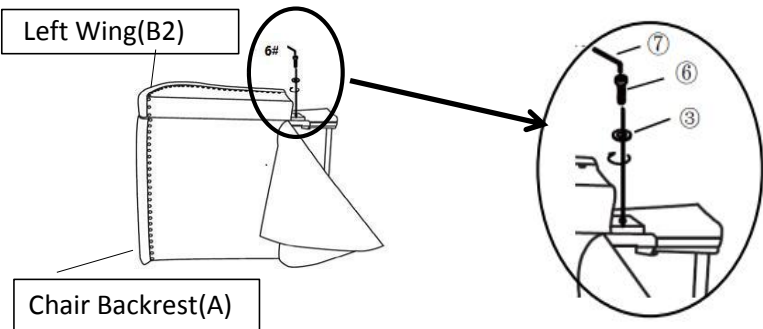

Attach Left Wing(B2) to the Chair Backrest(A) using Bolts(6) and Washer (3) with Allen Wrench(7). Fully tighten it until secure.

**Step 7**

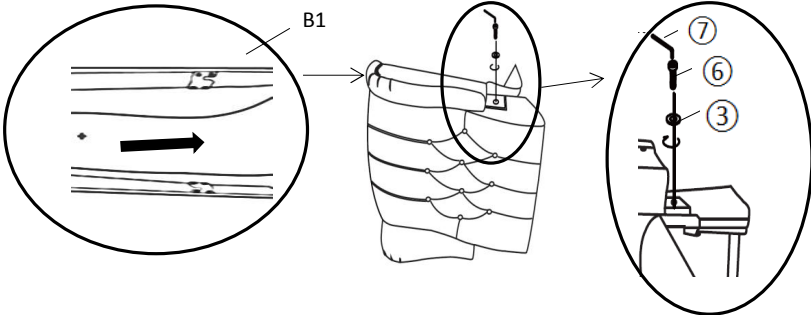

Repeat Step 5 and Step 6 to attach Right Wing(B1) to the right side of the Chair Backrest(A) using Bolts(6) and Washer(3) with Allen Wrench(7).

**Step 8**

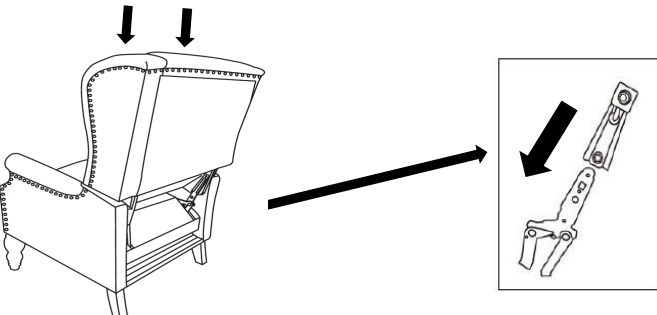

With assistance from your adult partner, hold up the fully assembled backrest with Wings, stand behind the chair. Insert the small metal arms on the sides of the Chair Backrest into the prefabricated slide lock gadget on the Chair Base as shown above.

Firmly but gently, push the Chair Backrest downwards until the **Backrest is fully slotted and locked into position.**

Step 9

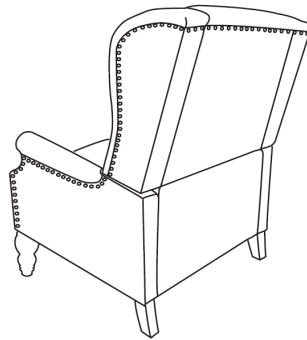

Smooth down the fabric flap on the Chair Backrest. Run your hands down both sides of the flap, from top to bottom, allowing the magic tape to adhere to the flap under the seat of the chair.

Step 10

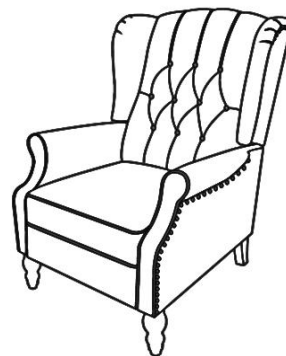

Make sure all parts are connected and securely locked into position. Your Chair is ready for use.

Step 11

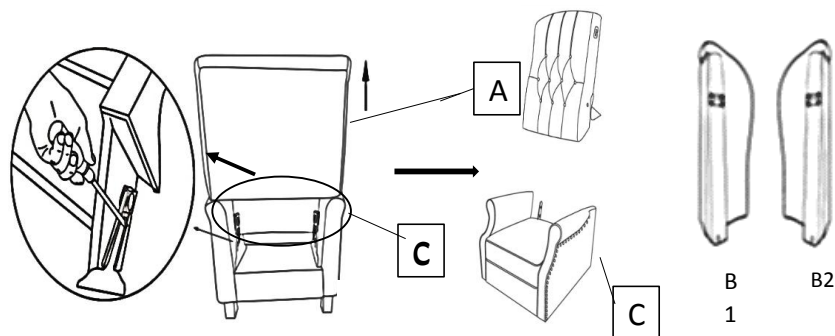

Disassembly Note: Open the flap on the Chair Backrest(A), use a screwdriver (Don't use fingers) pressing outward on the metal ear on the preattached Metal Bracket on one side of the Chair Base(C), with assistance of you adult partner to keep the Chair Base(C) in place, pull out the Chair Backrest(A) upward at the same time, repeat the same step for another side. Then the Chair Backrest(A) can be taken out.

# User Instructions.

## Recliner Chair

Please read the Instruction Manual below carefully before use.

This is a Recliner Chair. At anytime in a reclined seat position or in the upright position. You may enjoy the rocking motion by using your body weight in a back-front rocking motion.

Supervise children, when in use of this Recliner.

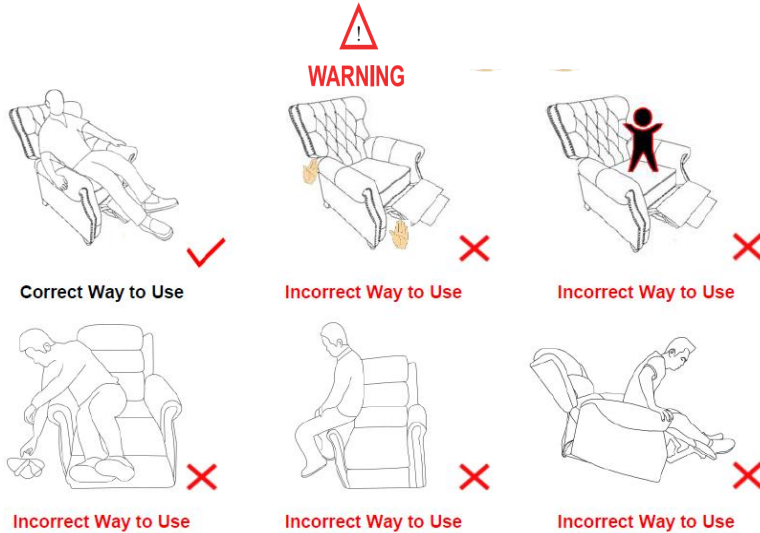

Always leave the chair in an upright and closed position after use.  
Keep hands and feet clear of the footrest mechanism and any gaps.  
Do not allow children to play on the chair.  
Do not lean to side to pick up anything while sitting on the chair.  
Do not sit on the arms.  
Do not stand up when the recliner open.  
Only the occupant should operate the chair.

### To get into a reclined posture - To Recline backrest

Sit into the seat.  
Place your feet apart .  
Place your left and right arm onto the armrest.  
Synchronise a backward push with your arms.  
Use your body weight and push backwards into the seat into a fully reclined position.

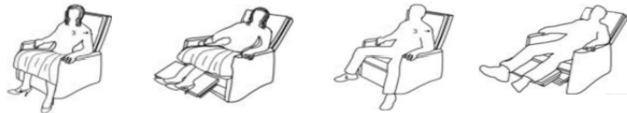

### To get out of chair - move Seatback into Upright Position

Tilt your body weight slightly forward and upwards.  
The seat back will come up to an upright position.  
Where necessary, use either your arms help lift- push yourself out of the seat.

