

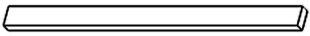

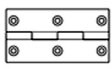

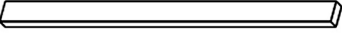





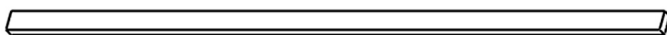

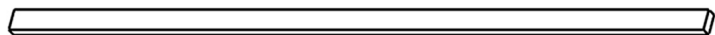

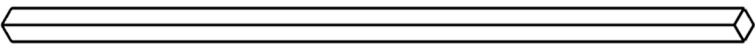
A		$\frac{640}{25.2}$	x4	J		x2
B		$\frac{670}{26.4}$	x3	K	 M4x $\frac{20}{0.8}$	x34
C		$\frac{1400}{55.1}$	x2	L	 M4x $\frac{35}{1.4}$	x30
D		$\frac{1420}{55.9}$	x14	M	 M4x $\frac{40}{1.6}$	x62
E			x6	N	 M5x $\frac{70}{2.8}$	x56
F			x4	O		x1
G			x14	P		x1
H			x2	Q		x1
I		$\frac{1460}{57.5}$	x4	R		x1
S			x4			

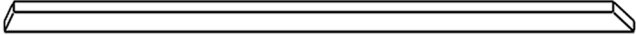
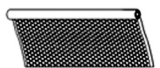
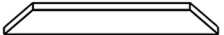

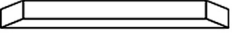

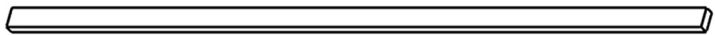
D		x14
E		x6
F		x4
G		x14
H		x2
K		x20
M		x62
N		x56
I		x4
S		x4

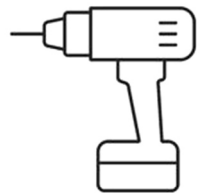
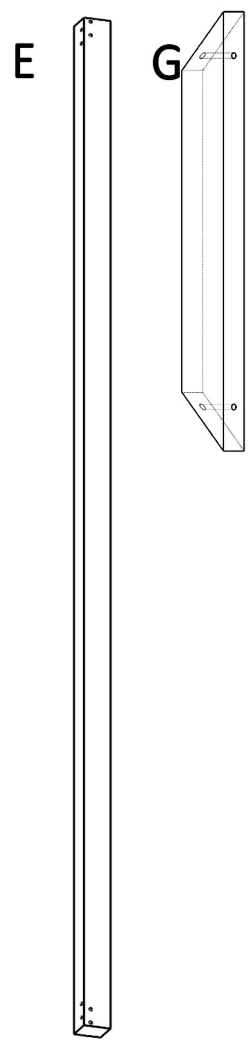
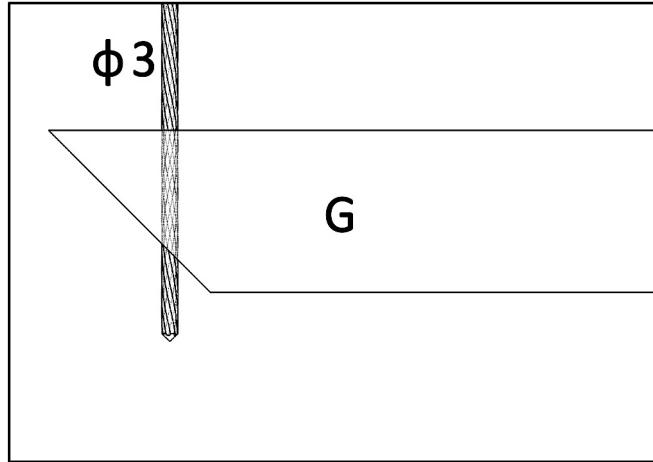
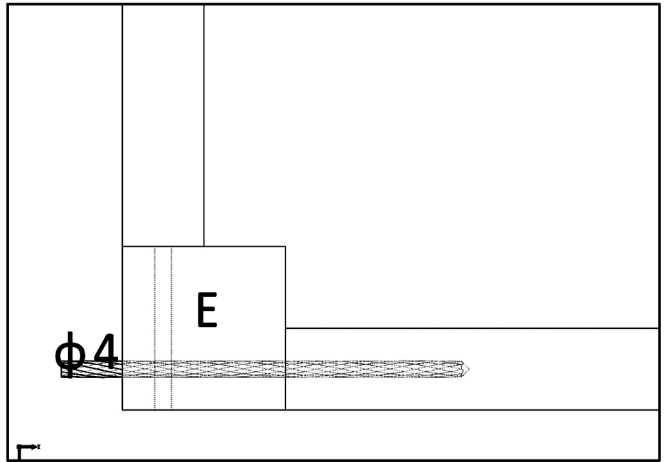
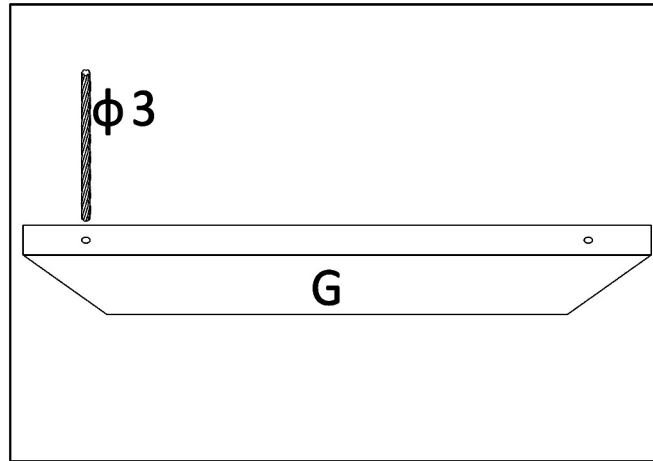
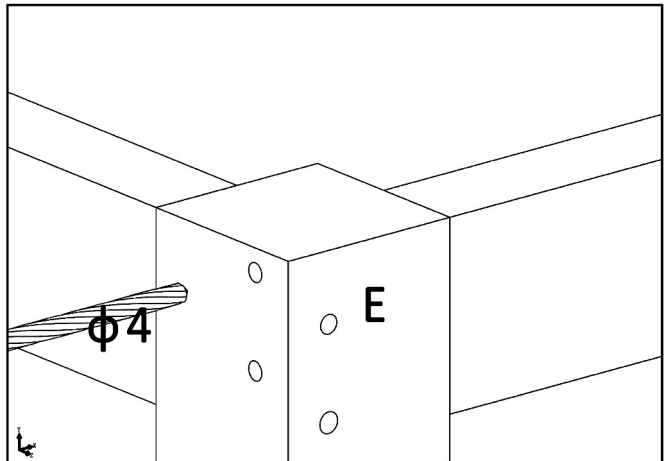
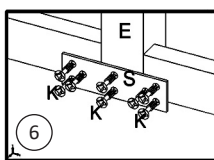
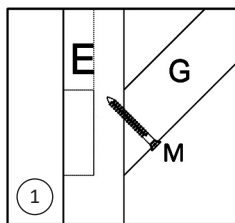
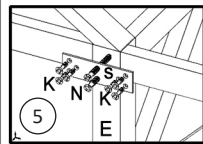
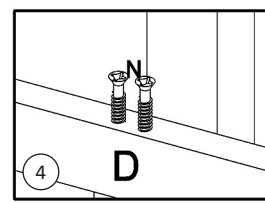
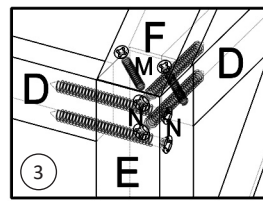
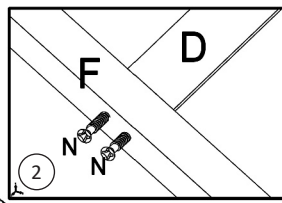
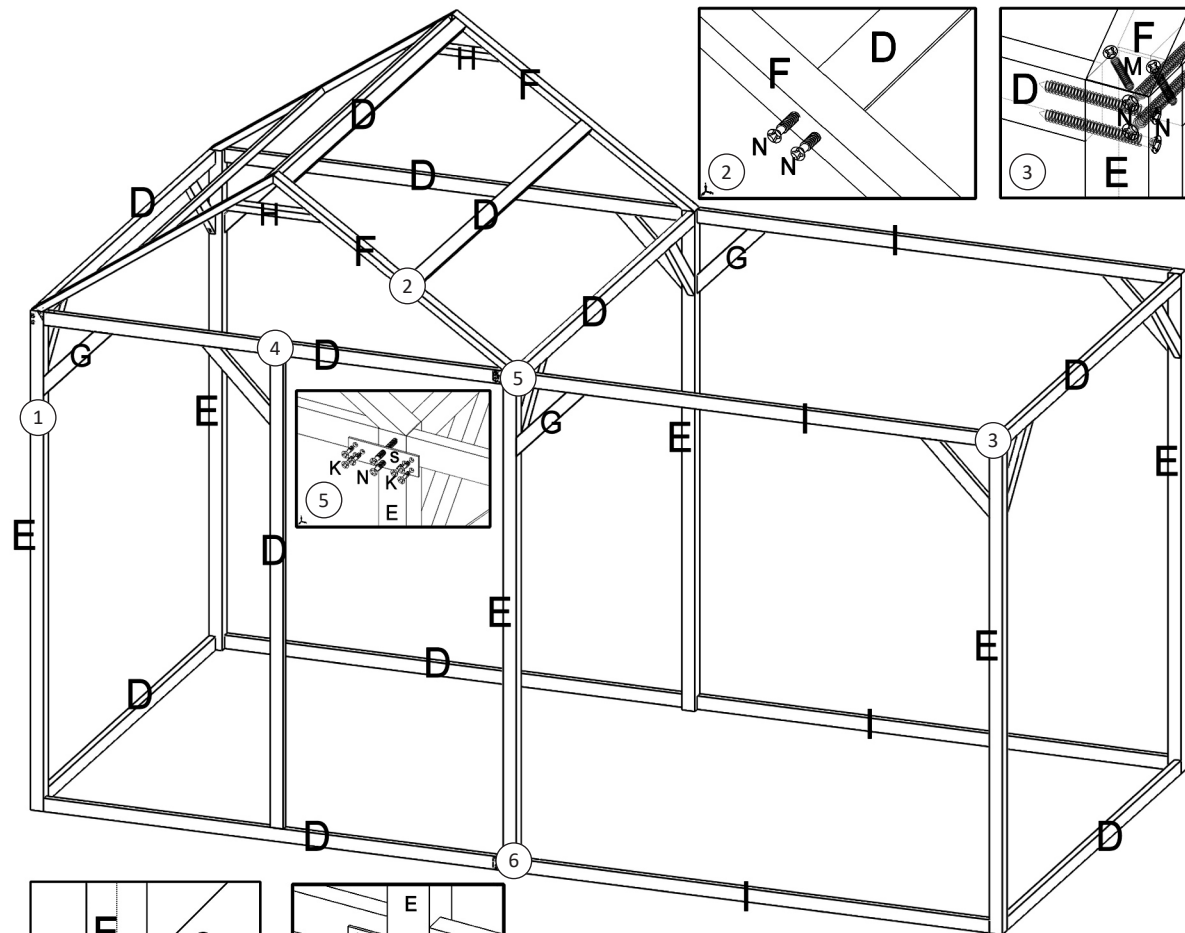
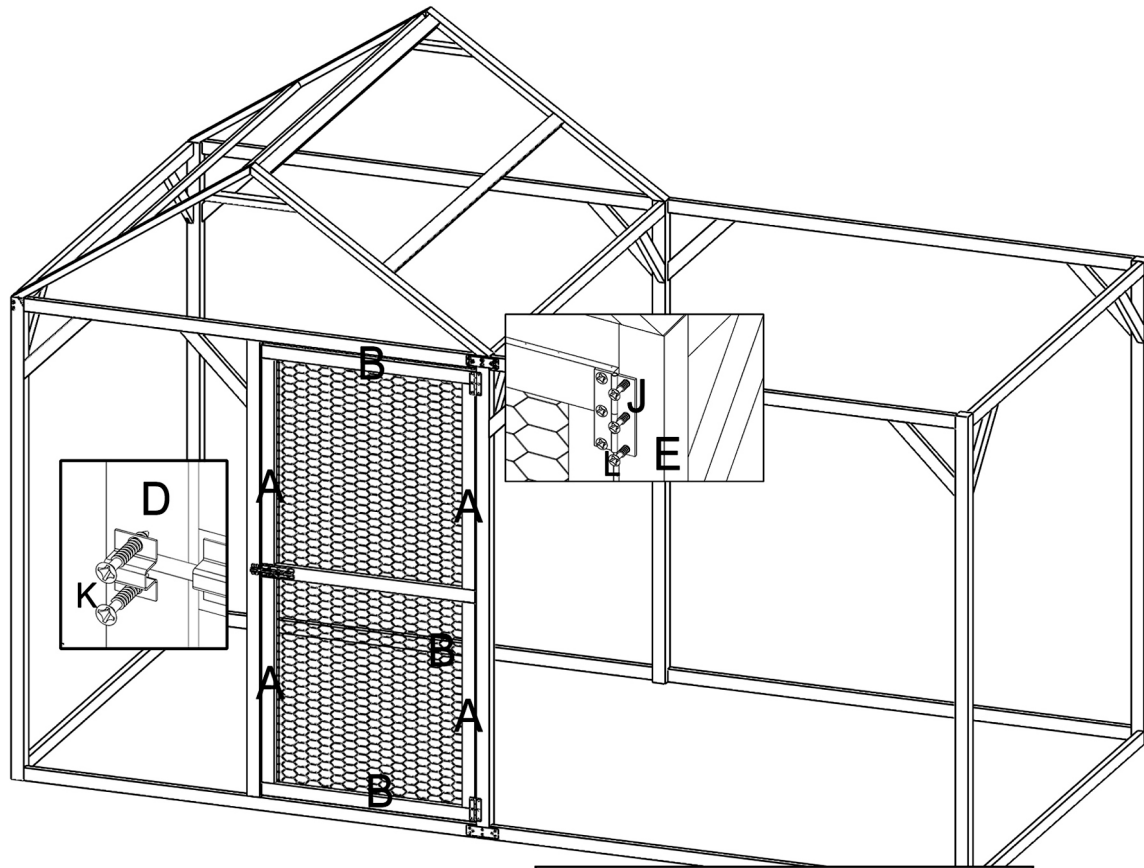

A		x4
B		x3
C		x2
R		x1
J		x2
O		x1
K		x6
L		x30

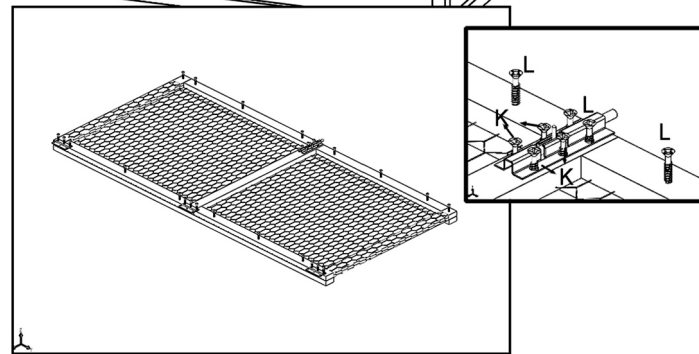
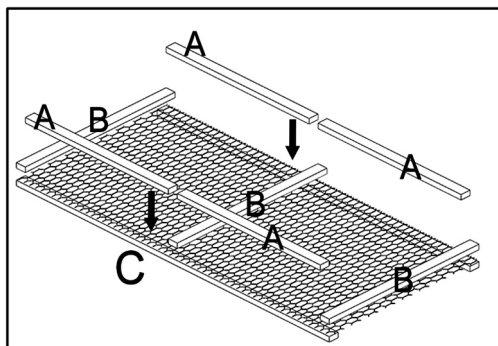

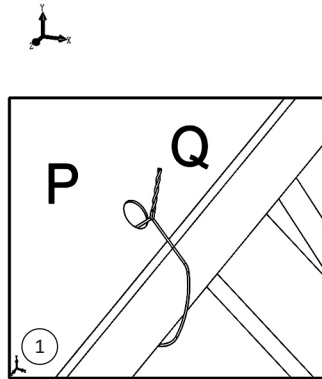
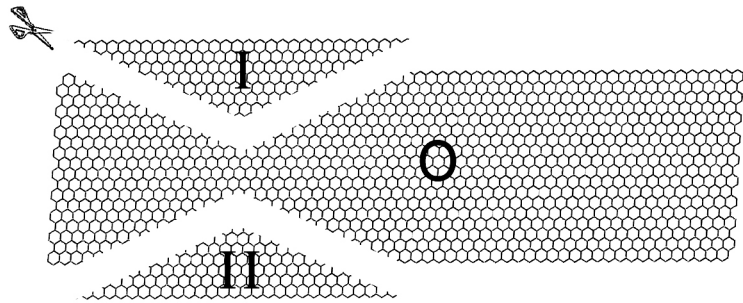
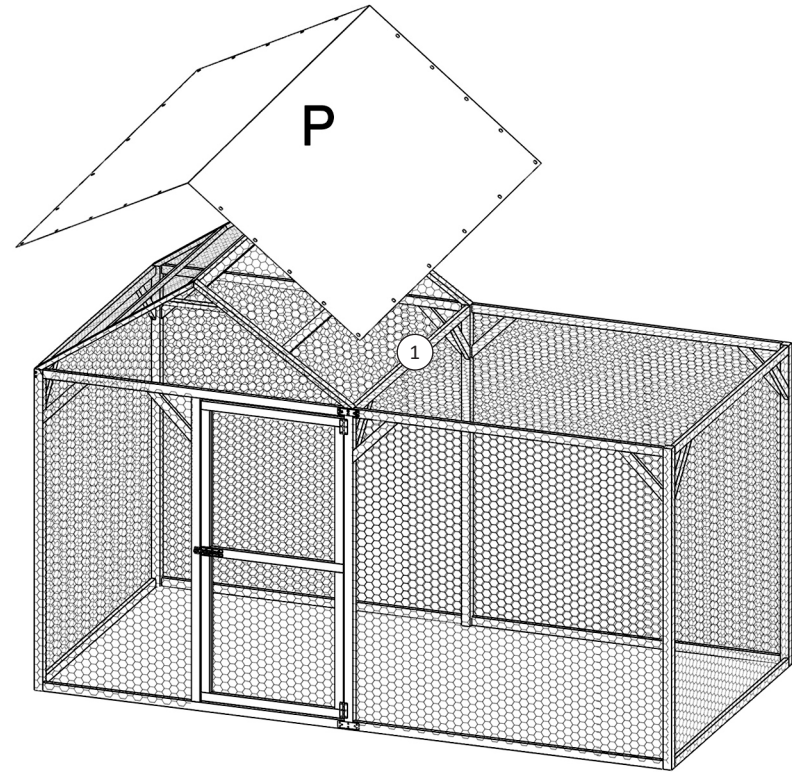
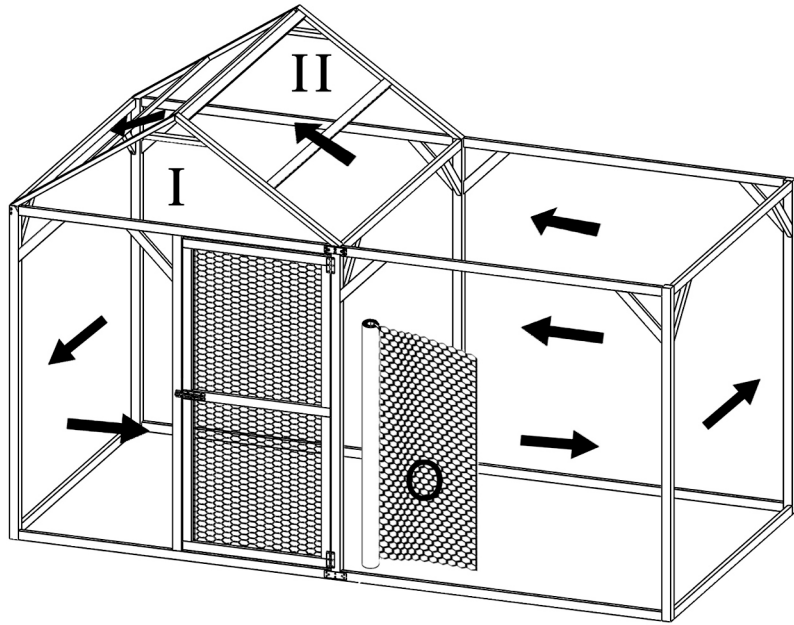

O		x1
P		x1
Q		x1