

ELECTRIC FIREPLACE OWNER'S MANUAL



AC 120V 60Hz
1500W

WARNING

Read and understand this entire owner's manual, including **all safety information**, **before plugging in** or **using** this product. Failure to do so could result in **fire, electric shock, or serious personal injury**.

CAUTION

Keep this owner's manual for future reference. If you sell or give this product away, **make sure this manual accompanies this product**.

IMPORTANT SAFETY INFORMATION!

WARNING

- **Read all instructions before using this heater!**
- This heater is **hot when in use**. To avoid burns, **DO NOT** let bare skin touch **hot** surfaces. If provided, use handles when moving this heater. Keep **combustible materials**, such as furniture, pillows, bedding, papers, clothes, and curtains at least **3 feet (0.9m)** from the **front of the heater**, and **keep them away from the sides and rear**.
- **Extreme caution** is necessary when any heater is used by or near **children** or **invalids** and whenever the heater is left **operating and unattended**.
- **DO NOT** operate any heater with a **damaged cord or plug** or after the **heater malfunctions**, has been **dropped or damaged in any manner**. Discard heater, or return to authorized service facility for examination and/or repair.
- **DO NOT** run **power cord** under carpeting. **DO NOT** cover power cord with throw rugs, runners, or similar coverings. **DO NOT** route power cord under furniture or appliances. Arrange power cord **away from traffic** area, and where it will not be tripped over.
- **DO NOT** insert or allow **foreign objects** to enter any **ventilation or exhaust opening**, as this may cause **electric shock** or **fire**, or **damage the heater**.
- To prevent a possible fire, **DO NOT** block air intakes or exhaust in any manner. Doing so could cause a **fire**. **DO NOT** use on soft surfaces, like a bed, where openings may become blocked.
- A heater has **hot and arcing or sparking parts inside**. **DO NOT** use it in areas where **gasoline, paint, or flammable liquids** are used or stored.
- **Use this heater only as described in this manual**. Any other use not recommended by the manufacturer may cause fire, electric shock, or injury to persons.
- **ALWAYS** plug heaters directly into a wall outlet/receptacle. **NEVER** use with an extension cord or relocatable power tap (outlet/power strip).
- **DO NOT** place the heater near a bed because objects such as pillows or blankets can fall off the bed and be ignited by the heater.
- **NEVER** use this heater in **bathrooms, laundry rooms**, or any other location where the heater could fall into a **bathtub** or **pool, become damp, or come in contact with water**.
- **AVOID FIRE!** Regularly inspect all air vents to make sure they are free from dust, lint, or other blockage. **Unplug the unit** and clean with a **vacuum ONLY**. **DO NOT** rinse or get wet.
- **NEVER** hang this unit on a wall **directly below an electrical outlet**.
- **NEVER** permanently install in a **recessed area of the wall**. This may result in **blocked air flow, overheating, or fire**.
- **ALWAYS** mount to wall bracket before use. **DO NOT** set on the floor, or other surface, to use.
- **NEVER** use a wall mount bracket from another manufacturer.

- **For residential use only! NOT for commercial use!** Any commercial or public use of this heater **voids all warranties**, and could cause **injury**.
- This product is **not intended** to be a **primary heat source**. It is for **supplemental heat only**.
- **INDOOR use only! NEVER** use this heater **outdoors!** Doing so may result in **electric shock!**
- **Risk of electric shock! DO NOT OPEN!** No user-serviceable parts inside!
- **NEVER modify this heater.** Doing so could result in personal **injury** or property **damage**. Modification of this fireplace **completely voids all warranties**.
- **ALWAYS** turn this heater off before unplugging it from the outlet.
- **ALWAYS disconnect** this unit from the **power supply before** performing any assembly or cleaning, or before relocating the electric fireplace.
- **NEVER** leave this heater unattended. **ALWAYS** unplug this heater when not in use.
- **ALWAYS** store this heater in a dry location. **NEVER** use the fireplace if it has become wet.
- Place the heater near a wall outlet so an extension cord is not needed. If an extension cord is needed, the **gauge** of the cord **must be at least 14AWG**, and the **rating must be at least 1875 Watts**. **NEVER** use a **smaller gauge** cord with a **lower rating**. Doing so may result in **fire or electric shock**.
- **ONLY** use this heater on a **120V AC 15-Amp grounded circuit**. **NEVER overload the circuit**. If this heater trips the circuit breaker, unplug all other appliances on the same circuit before the next use. Avoid plugging other appliances into the same circuit as this heater.
- **NEVER** plug this heater into an outlet that is **old, cracked**, or has any **loose wires or connections**. Plugging this heater into a faulty outlet could result in **electric arcing** within the outlet that could cause the **outlet to overheat or catch fire**.
- **ALWAYS** check your heater cord and plug connections with **each use!**
 - i) **MAKE SURE** the plug fits tight in the outlet! Faulty wall outlet connections or loose plugs can cause the outlet to overheat.
 - ii) **Heaters draw more current** than small appliances. **Overheating** may occur even if it has not occurred with the use of other appliances.
 - iii) During use **check frequently** to see if the **plug outlet or face plate is HOT!**
 - iv) If the outlet or face plate is **HOT, discontinue use immediately** and have a qualified electrician inspect and/or replace the faulty outlets.
- Plug the power cord into a properly grounded socket (AC 120 V, 60 Hz). Do not use an extension cord or power strip.

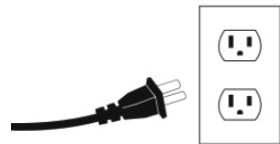

- **SAVE THESE INSTRUCTIONS!**

Preparation







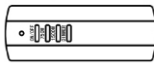

This product includes a **GLASS panel!** Always use **extreme caution** when handling **glass**. Failure to do so could result in **personal injury** or **property damage**.

Remove all parts and hardware from the carton and place them on a clean, soft, dry surface. Parts and assembly steps are grouped for wall-hanging use. Check the parts list to make sure nothing is missing. Dispose of packaging materials properly. Please recycle whenever possible.

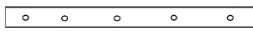
You will need the following tools (not included): Phillips screwdriver; level; tape measure; electric drill; 1/4" wood drill bit, hammer.

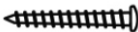
Parts and Hardware

 A –1x Fireplace	 B –1x Remote Control	 C –Decorative Pebbles
	 D –1x LARGE WALL-MOUNTING BRACKET	 E: 7x SCREW EXPANSION TUBES
 F- 2x SMALL BLACK SCREWS	 G - 7X LONGER BLACK SCREWS	 H –1x SMALL BRACKET

Installation and Assembly

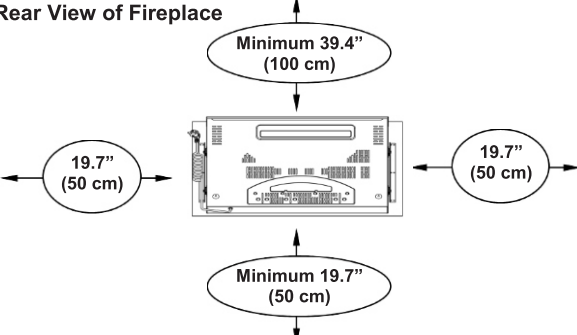
<p>Rear View of Fireplace</p> 	<p>Step 1. Find a safe location. Minimum clearance on each side: 19.7" (50 cm). Minimum clearance below: 19.7" (50 cm). Minimum clearance above: 39.4" (100 cm). Minimum clearance from the front and sides: 3 feet (90 cm). Choose a location near an outlet so an extension cord is not required. DO NOT position the unit directly below a power outlet. See Safety Information on pages 2 and 3 for warnings about safe placement, safe installation, and proper use of this product.</p>
---	--

NOTICE

The wall mount fasteners included with this fireplace are for use **ONLY** with a concrete walls. For wood walls, cinder blocks, or other wall types, consult a professional for the best attachment methods.



ALWAYS unplug this fireplace heater **before assembly** or **cleaning**, or **before relocating**. Failure to do so could result in **electric shock**, **fire**, or **personal injury**.

Step 2: Installation

1. This appliance is designed to be permanently fixed to a wall at a minimum height of 11.81"(300mm).The wall bracket must be fitted horizontally and the cable routed to the bottom right of the heater.
2. A distance of 23.62"(600mm) from bottom of heater to floor is recommended for optimum viewing of fuel bed.
3. For optimum viewing, mark the top five screws fixing positions on wall in accordance with the recommend fixing dimensions.
4. Drill holes with a No. six drill bit.
5. Fix the wall bracket using that the plug and screws provided.

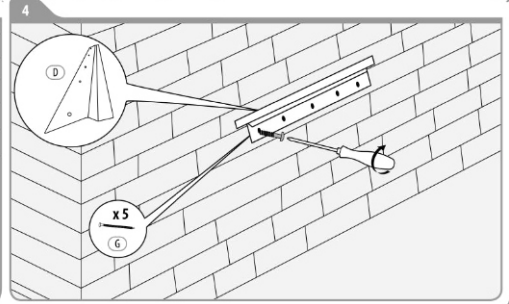
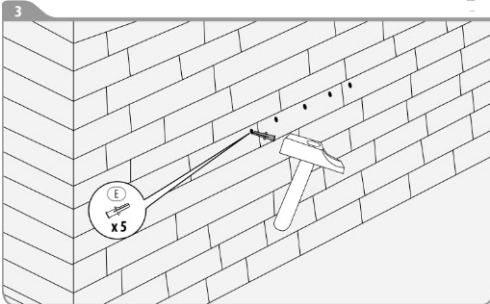
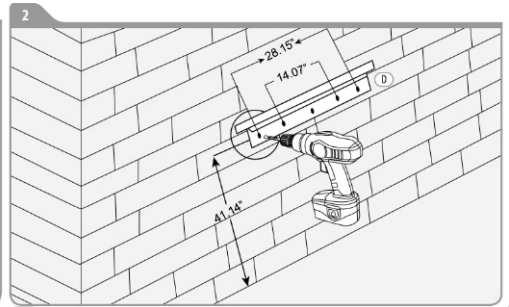
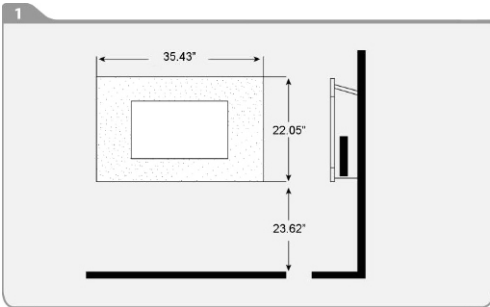

6. Attach the lower fixing bracket the base of the fire using the two small black screws supplied; ensure the bracket is fitted so that it is level with the back.
7. Carefully lift the heater up ensuring that the top rear ledge of heater engages with the wall bracket and is sitting centrally. This process should be carried out by two people to avoid injury or damage to property or the appliance.

8. Gently bring the heater down against the wall.
9. Mark the lower fixing bracket two fixing hole positions on the wall, remove the heater.
10. Drill the wall and insert the wall plugs.
11. Refit the heater to the wall and fasten the bottom fixing bracket to the wall using the screws provided to permanently fix the heater in place.

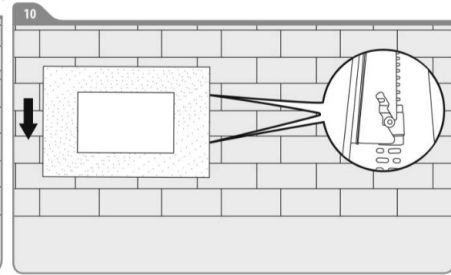
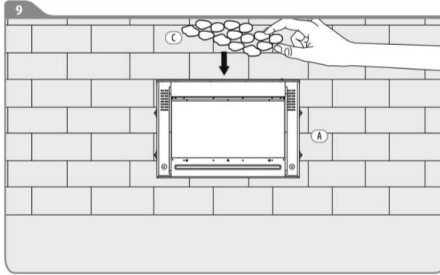
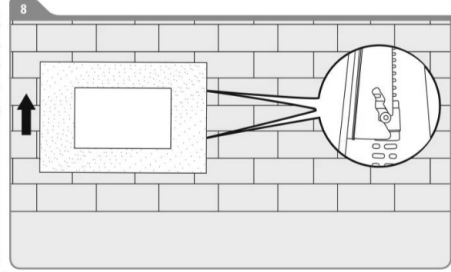
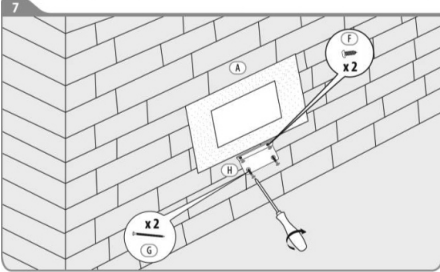
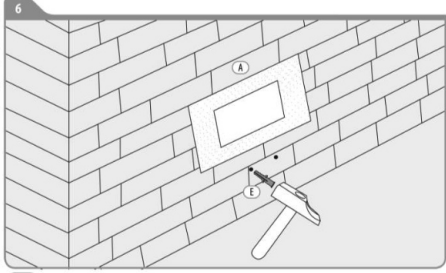
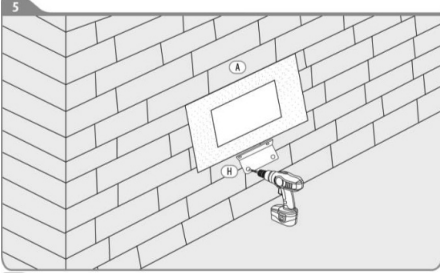

12. Unpack the pebbles from the bag and place them along the light unit in the desired position.
13. Place the front surround over the front of the fire aligning the slots in the brackets at each side of the front panel with the lugs on the sides of the fire. Again two people will be required for this operation.



ALWAYS unplug this fireplace heater **before assembly** or **cleaning**, or **before relocating**. Failure to do so could result in **electric shock**, **fire**, or **personal injury**.

IMPORTANT GLASS PANEL SAFETY INFORMATION!



WARNING

- **Under no circumstances** should this product be **operated with broken or chipped** glass panels.
- **Do not strike, slam** or use **blunt force** on any part of the glass.
- **Do not use abrasive** cleansers to clean the glass.
- This product uses **tempered glass**. **Replacement** of the glass supplied by the manufacturer should be done by a **qualified professional**.



This next step involves **GLASS! ALWAYS** use **extreme caution** when handling glass. Failure to do so could result in **personal injury** or **property damage**.

Decorative Pebbles Media



ALWAYS keep the decorative pebbles **OUT OF REACH OF CHILDREN!** Leave no pieces where children can find them. Failure to do so could cause a choking hazard.

Operation



Read and understand this entire owner's manual, including all safety information, before **plugging in** or using this product. Failure to do so could result in **electric shock, fire, serious injury, or death.**

Power

Make sure the ON/OFF switch, located on the top right side panel, is in the OFF position. Plug the power cord into a 120 Volt 15 Amp grounded outlet (see **IMPORTANT SAFETY INFORMATION** on **Pages 2 and 3**). Make sure the outlet is in good condition and that the plug is not loose. **NEVER** exceed the maximum amperage for the circuit. **DO NOT** plug other appliances into the same circuit.

Methods of Operation

This electric fireplace can be operated by the CONTROL PANEL, located on the right side panel of the fireplace (see figure below), or by the battery-powered REMOTE CONTROL.

The operation and functions of the two methods are the same.

Before operating, please review the **IMPORTANT SAFETY INFORMATION** on **Pages 2 and 3**, and heed all warnings.

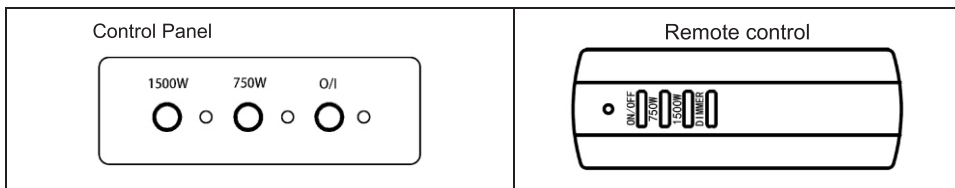
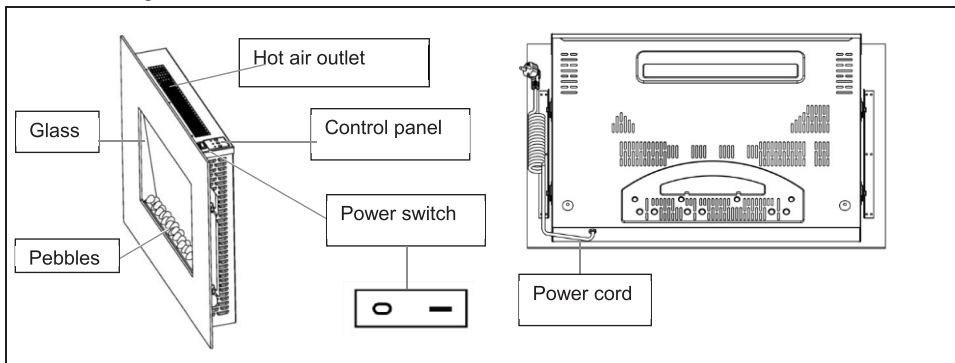

Remote Control & Control Panel Operation

(Control panel POWER switch must be ON to use remote control.)

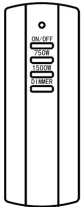
	O	Appliance powered off
	I	Appliance powered on, set to standby mode
1500W 750W O/I	O/I	> Press to switch the flame effect on/off. > Press and hold to toggle between 5 different flame dim levels
	750W	Press to activate low level heating
	1500W	Press to activate high level heating
	ON/OFF	Press once. Press to switch the flame effect on/off. Press again. Flame effect turns off. Unit goes to standby. All functions turn off.
	750W	Press to activate low level heating, press again to off the heat setting
	1500W	Press to activate high level heating, press again to off the heat setting
	Dimmer	Press once, flame brightness effect gets changing. Press again until desired setting is reached.

NOTICE

When the heater is first turned on, a slight odor may be present. This is normal and should not occur again unless the heater is not used for a long period of time.

NOTICE

To improve operation, **aim** the remote control at the front of the fireplace. **DO NOT press the buttons too quickly.** Give the unit time to respond to each command.

Temperature Limiting Control

This heater is equipped with a Temperature Limiting Control. Should the heater reach an unsafe temperature, the heater will automatically turn OFF. To reset:

1. Unplug the power cord from the outlet.
2. Turn the ON/OFF switch on the CONTROL PANEL to OFF. **Wait 15 minutes.**
3. Inspect the fireplace to make sure no vents are blocked, or clogged with dust or lint. If they are, use a vacuum to clean the vent areas.
4. With the POWER switch in the OFF position, plug the power cord back into the outlet.
5. If the problem continues, have your outlet and wiring inspected by a professional.

Remote Control Battery Information

- This remote control uses 2XAAA **battery** (not included).

- Instructions for battery installation are on the Remote Control battery compartment.



NEVER dispose of batteries in **fire**. Failure to observe this precaution **may result in an explosion**. Dispose of batteries at your local hazardous material processing center.

Care and Maintenance

Cleaning



ALWAYS turn the heater **OFF** and **unplug the power cord from the outlet** before cleaning, performing maintenance, or moving this fireplace. Failure to do so could result in **electric shock, fire, or personal injury**.



NEVER immerse in water or **spray with water**. Doing so could result in **electric shock, fire, or personal injury**.

Metal:

- Buff using a soft cloth, slightly dampened with a citrus oil-based product.
- **DO NOT** use brass polish or household cleaners as these products will damage the metal trim.

Glass:

- Use a good quality glass cleaner sprayed onto the cloth or towel. Dry thoroughly with a paper towel or lint-free cloth.
- **NEVER** use abrasive cleansers, liquid sprays, or any cleaner that could scratch the surface.

Vents:

- Use a vacuum or duster to remove dust and dirt from the heater and vent areas.

Plastic:

- Wipe gently with a slightly damp cloth and a mild solution of dish soap and warm water.
- **NEVER** use abrasive cleansers, liquid sprays, or any cleaner that could scratch the surface.

Maintenance



Risk of electric shock! DO NOT OPEN any panels No user-serviceable parts inside!



ALWAYS turn the heater **OFF** and **unplug the power cord from the outlet** before cleaning, performing maintenance, or moving this fireplace. Failure to do so could result in **electric shock, fire, or personal injury**.

Electrical and Moving Parts:

- The fan motors are lubricated at the factory and will not require lubrication.
- Electrical components are integrated in the fireplace and are not serviceable by the consumer.

Storage:

- Store heater in a clean dry place when not in use.

Troubleshooting

WARNING

DISCONNECT THE APPLIANCE COMPLETELY AND LET COOL PRIOR TO ANY SERVICE. ONLY A QUALIFIED SERVICE PERSON SHOULD SERVICE AND REPAIR THIS ELECTRIC APPLIANCE.

Problem	Possible Cause	Solution
1. Fireplace turns off and will not turn on.	1. Fireplace has overheated and safety device has caused thermal switch to disconnect or home circuit breaker has opened.	1. Reset switch by turning main power switch off and waiting 15 minutes then turning it back on. 2. Reset circuit breaker.
2. Flame is not moving.	1. Loose wiring. 2. Flame motor defective. 3.Flame rod out of place	1. Inspect wiring for loose connections. 2. Call a qualified service technician to replace flame motor. 3."Flame Rod" out of place due to rough transit/handling of the product. This issue can be corrected as simple as removing the glass, flipping the fireplace upside down, removing a set of screws that are holding the bottom frame plate and placing the flame rod back into place.
3. Flame is not visible.	1. Wiring is loose.	1. Disconnect from power source and inspect wiring for loose connections and repair or replace as necessary. 2.Push the flame button to high position.
4. Remote control does not work.	1. Low batteries. 2. Not aiming control correctly. 3. Defective remote control and /or sensor.	1. Replace batteries in remote control. 2. Aim control at sensor located directly behind glass screen in center of unit just above logs. 3. Replace remote control and/or sensor.
5. Fireplace will not turn on when switch is flipped to ON.	1. Fireplace is not plugged in to an electrical outlet. 2. Control failure. 3. Breaker tripped.	1. Check plug. 2. Call a qualified service technician. 3. Reset breaker.

6. Heater does not provide heat when turned on.

1. Thermal switch has been tripped.

2. Wiring is loose.

3. Heater is defective.

1. Turn unit off and unplug unit for 15 minutes. Plug back in and turn unit on. If plug cannot be reached, follow directions for tripped circuit breaker.
2. Disconnect from power source and inspect wiring for loose connections and repair or replace if necessary.
3. Replace heater.

CAUTION:Please remember to always have the unit disconnected prior to any work, always lay glass as well as the unit on a towel or other material not to damage parts/frame.