

# Assembly Instruction

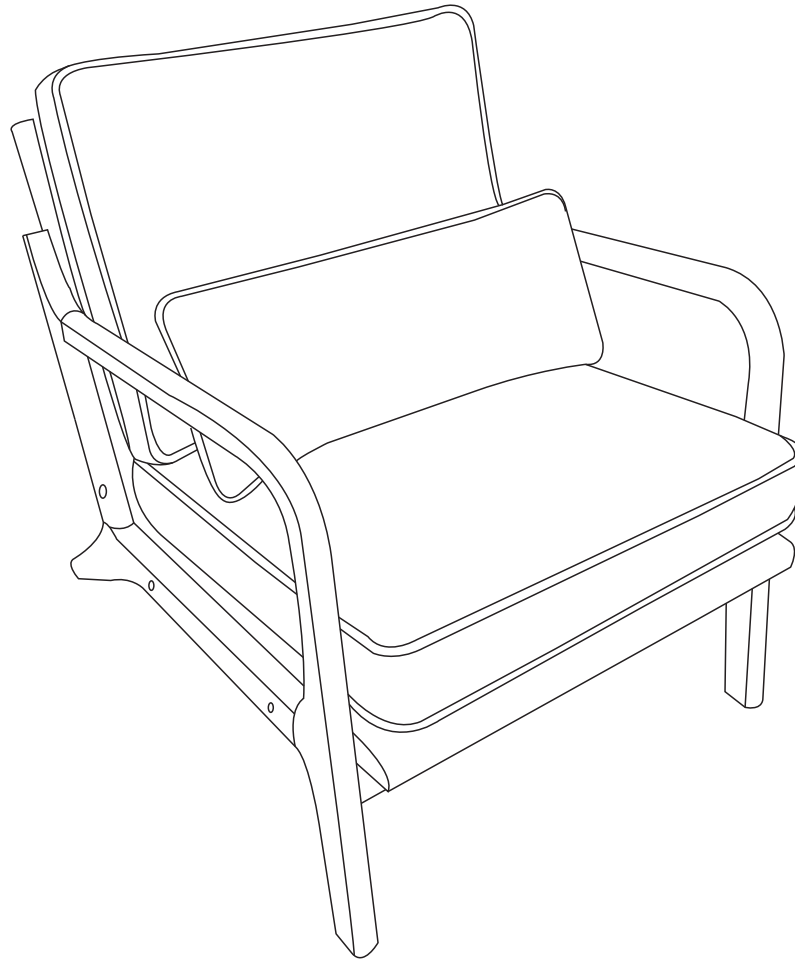

**Attention:** Do not open the compression bag if you are not satisfied with the product







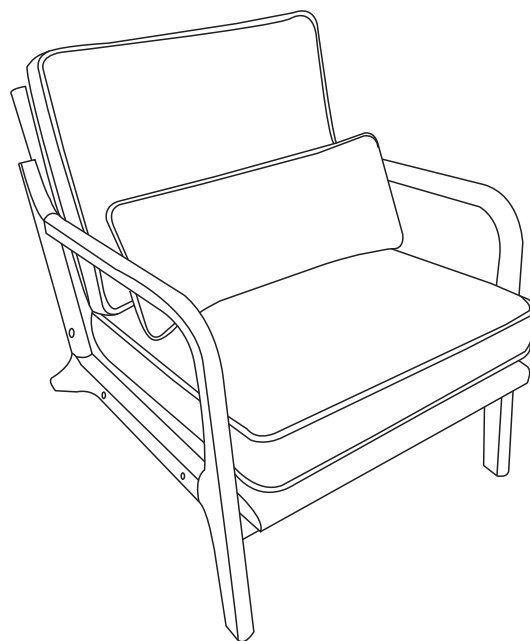
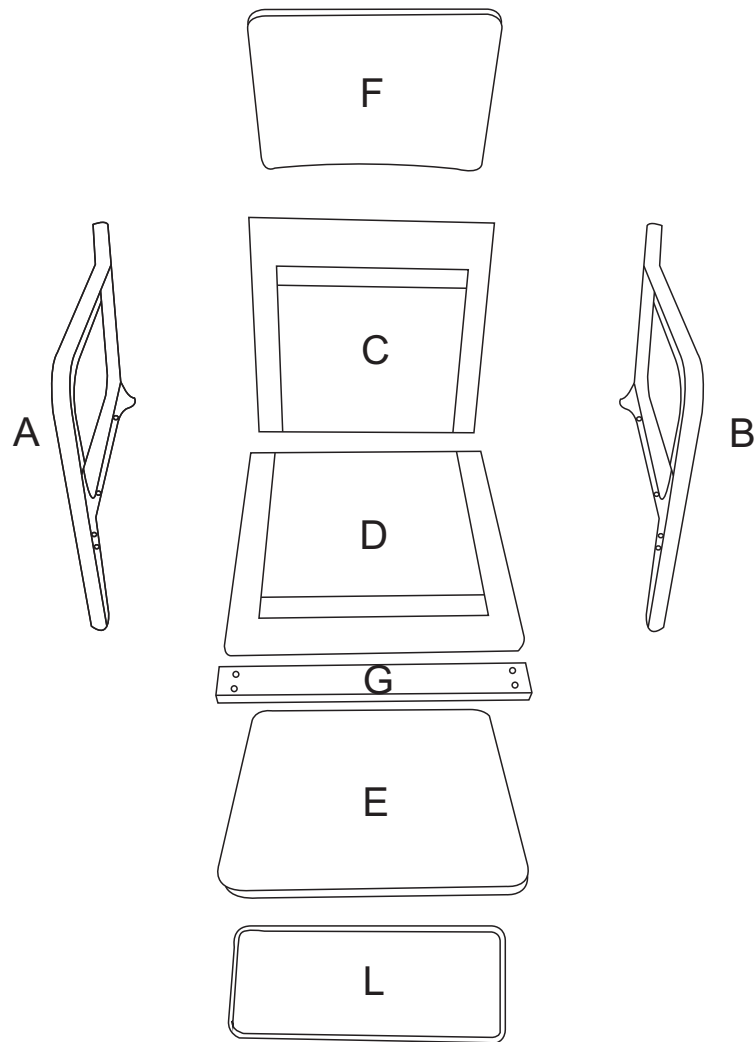

Thank you for your purchase.

If you have difficulty with assembly or find a part is missing or damaged, please don't hesitate to contact us for solution.

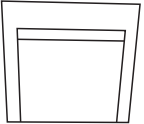
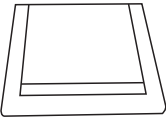
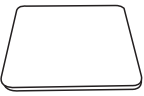
Customer Service team will work hard to put a smile back on your face.

# Components

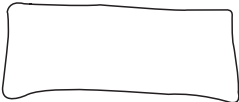

NO	PARTS	QTY	DESCRIPTION
A		1 PC	Left Arm-rest frame
B		1 PC	Right Arm-rest frame
C		1 PC	Back frame
D		1 PC	Seat frame
E		1 PC	Seat Cushion
F		1 PC	Back Cushion
G		1 PC	Crosspiece
H		8 PCS	M8*40mm Screw
I		4 PCS	M8*60mm Screw
J		1 PC	Allen Key
K		12 PCS	Cork
L		1 PC	Waist pillows

## STEP 1

Connect Arm A/B to Crosspiece G with screw I

Note: screw should only be 70% tight

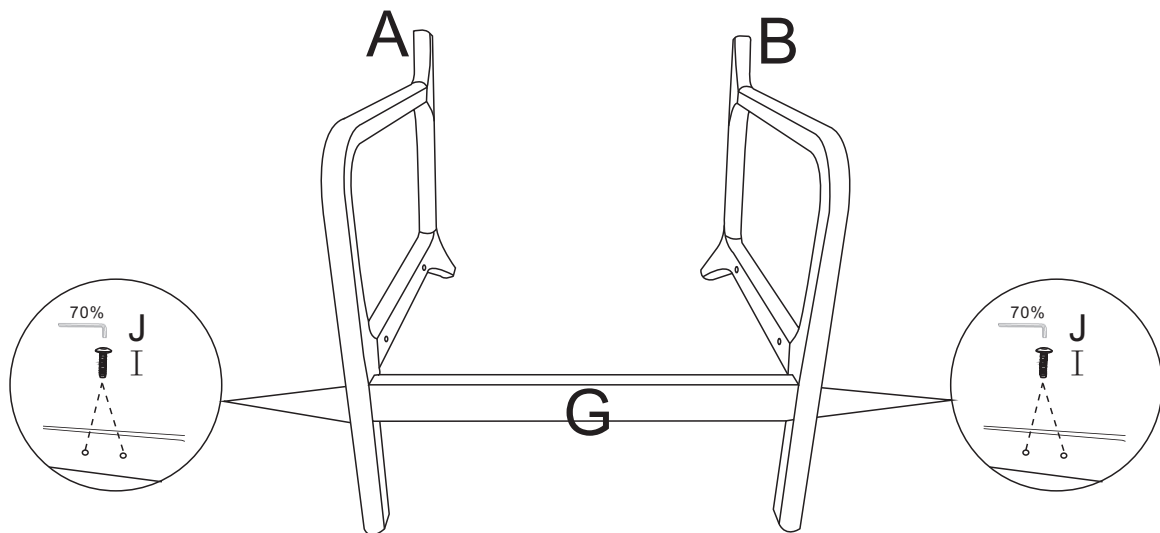

## STEP 2

Connect Seat frame D to Arm A/B with screw H  
(Install the screws near the front of the seat first)

Note: screw should only be 70% tight

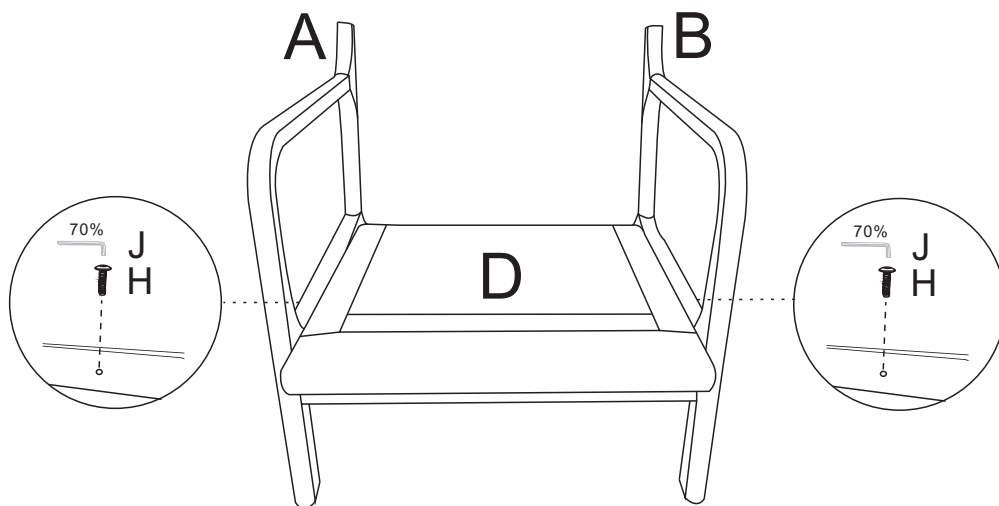

### STEP 3

Connect Seat frame D to Arm A/B with screw H  
(Next install the screws near the back of the seat)

Note: screw should only be 70% tight

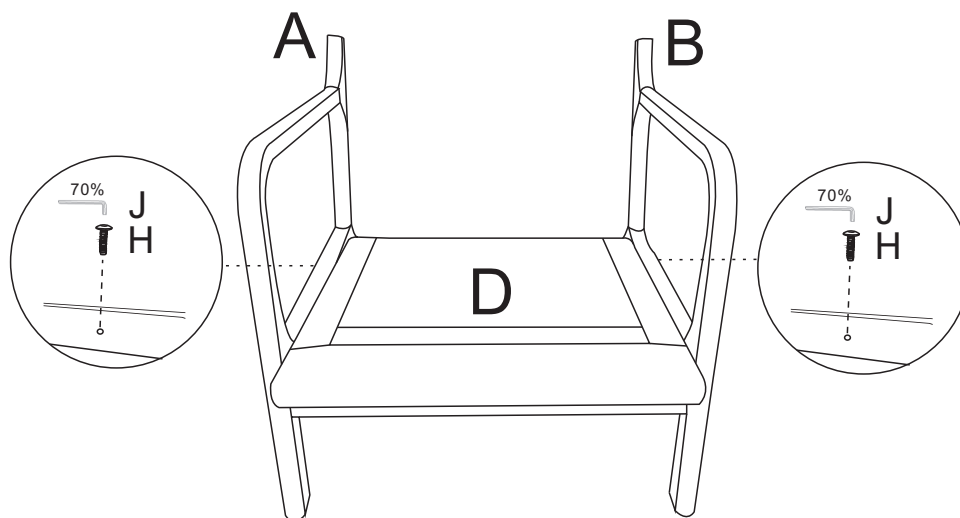

### STEP 4

Connect Back frame C to Arm A/ B with screw H

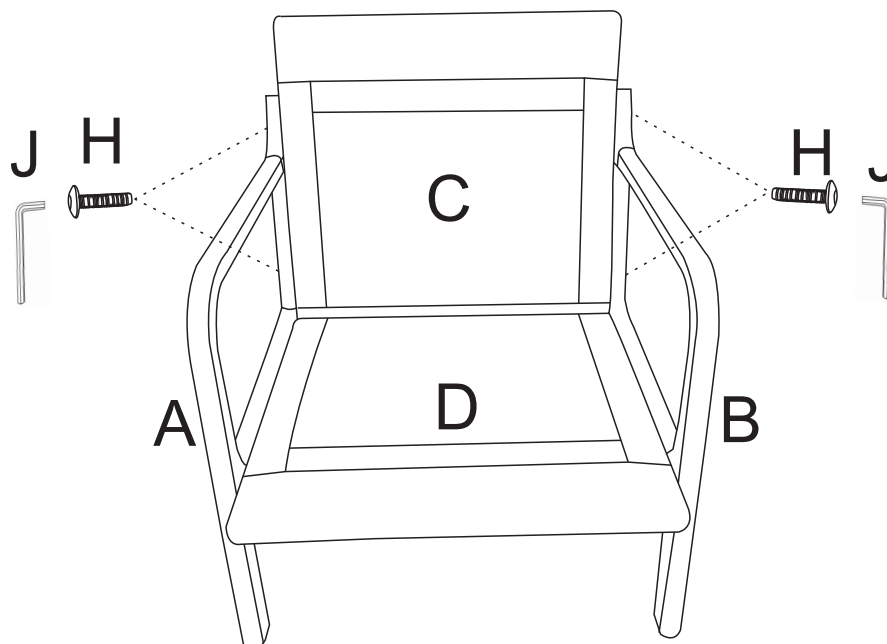

## STEP 5

Tighten all screws

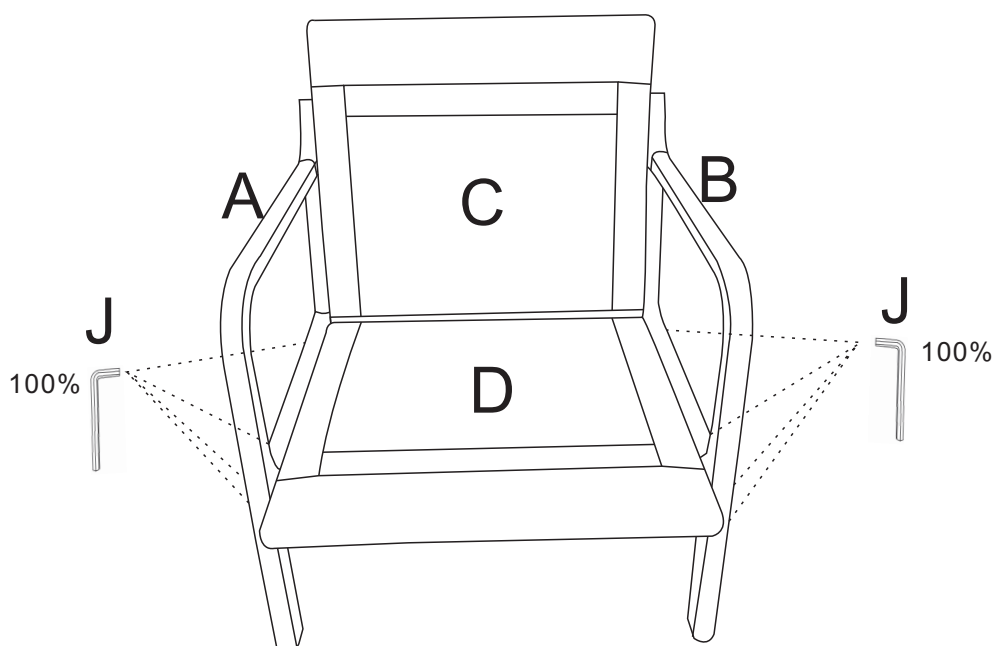

## STEP 6

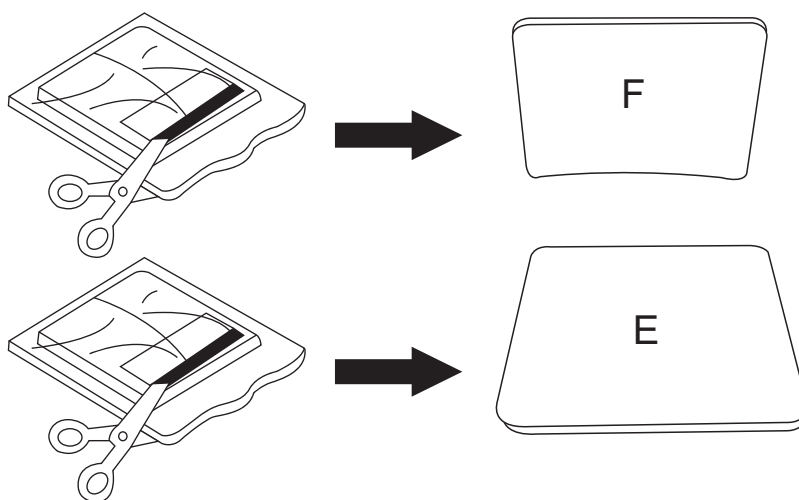

1. Cut open the compression package and remove the seat cushion and back cushion
2. Compression package after cutting, after standing for 24 hours, more comfortable

**STEP 7**

Load in the cork

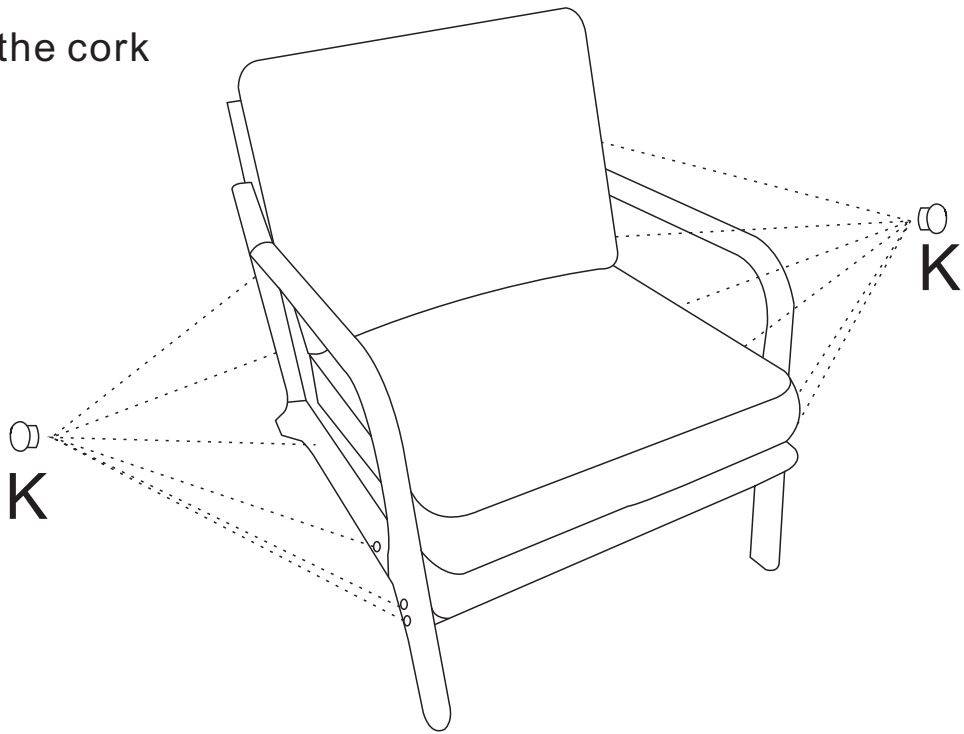

**STEP 8**

Have cushion E/F/L placed respectively

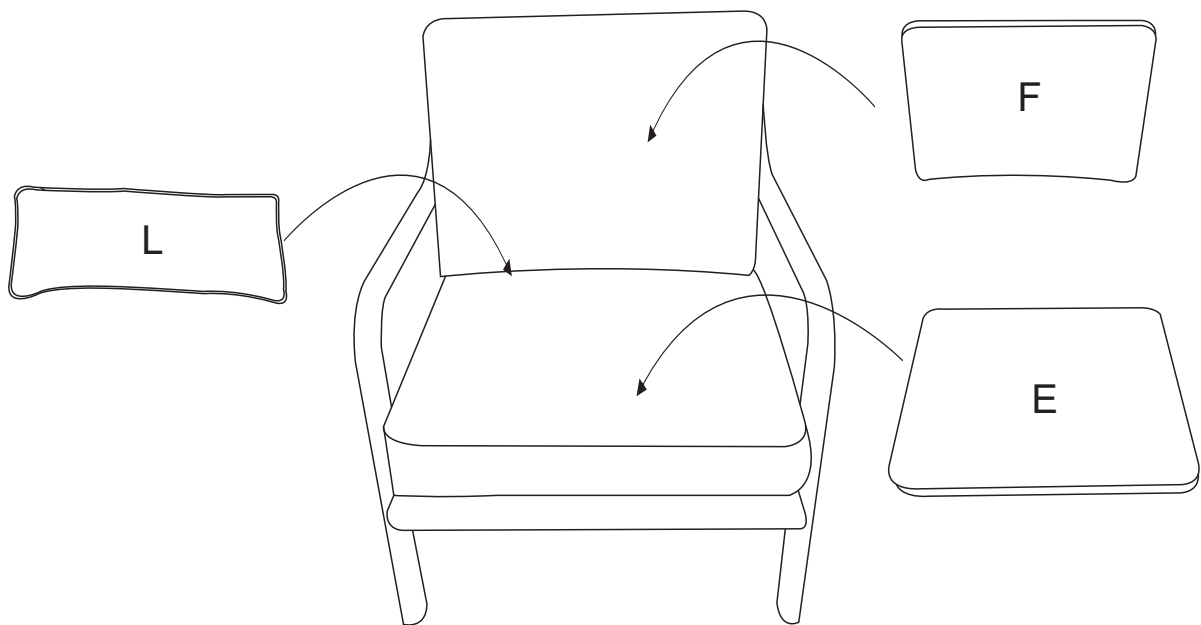

**STEP 9**

Well done!

