



44 Avenue Paul Girard
10500 DIENVILLE
FRANCE
www.sciae.com

CASTEL

INDICE A - 11/03/2025
CASTEL 3336 BIBLIOTHEQUE 1PO N°03A Réf: 25SB3610

EAN: 3102000114668

NOTICE DE MONTAGE
ASSEMBLING INSTRUCTIONS
MONTAGEANLEIUNG
MANUAL DE MONTAJE
MONTAGEVOORSCHRIFT
INSTRUÇÕES DE MONTAGEM
ISTRUZIONI DI MONTAGGIO
ИНСТРУКЦИЯ ПО СБОРКЕ
Naputci za montažu

MEUBLE DESTINE A ETRE
FIXE AU MUR

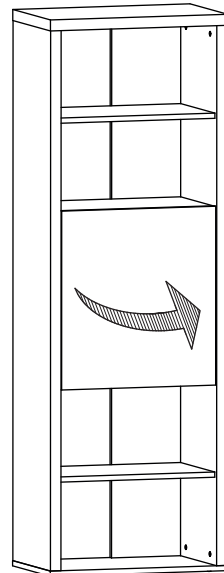
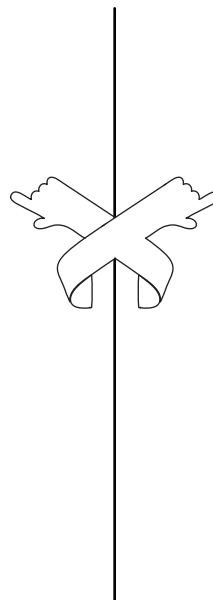
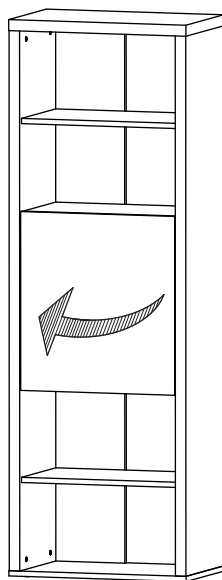

FURNITURE TO BE FIXED
TO THE WALL

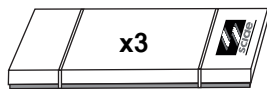

IDU: FR025980_03HVXT

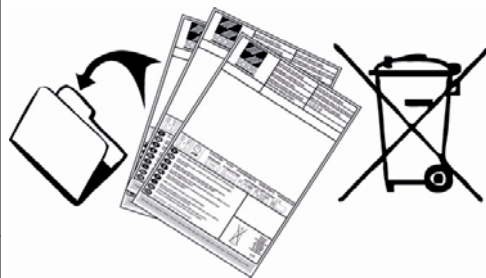

Package 1: 30 Kg
Package 2: 23.5 Kg
Package 3: 18.5 Kg



- F** POUR L'APRES-VENTE, RETOURNEZ AU MAGASIN AVEC CETTE NOTICE
- GB** FOR THE AFTER SALES, GO BACK TO THE SHOP WITH THIS ASSEMBLY INSTRUCTION
- D** WENDEN SIE SICH BITTE AN IHREN HANDLER UND GEBEN SIE IHM DIE KENNUMMER DES MOBELS UND DIE TEILNUMMER
- E** EN CASO DE SERVICIO POST-VENTA DEBEN DE VOLVER A LA TIENDA CON LAS INSTRUCCIONES DE MONTAJE
- NL** VOOR SERVICE NA VERKOOP, GA NAAR UW LEVERANCIER MET DEZE MONTAGE HANDLEIDING
- P** PARA O POS VENDA, VOLTE A LOJA COM ESTA FOLHA
- I** SERVIZIO POST VENDITA: E NECESSARIO PRESENTARSI SUL PUNTO VENDITA CON QUESTE ISTRUZIONI DI MONTAGGIO
- RU** ДЛЯ ПОСЛЕПРОДАЖНОГО ОБСЛУЖИВАНИЯ ПРОСЬБА ОБРАТИТЬСЯ В МАГАЗИН ПРЕДЪЯВИВ НАСТОЯЩУЮ ИНСТРУКЦИЮ ПО СБОРКЕ
- HR** U SLUČAJU REKLAMACIJE, VRATITE SE NA PRODAJNO MJESTO S OVIM UPUTAMA ZA MONTAŽU

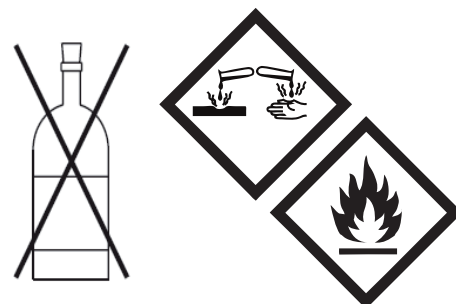
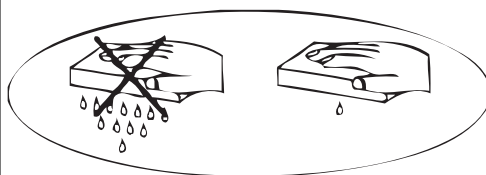

	+40°C +104°F	
	HYGROMETRIE HYGROMETRY 40%-65%	
	+15°C +59°F	

1 an
1 year

OK

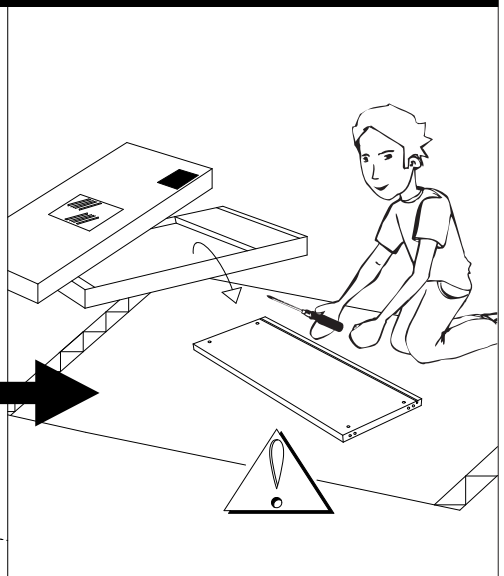
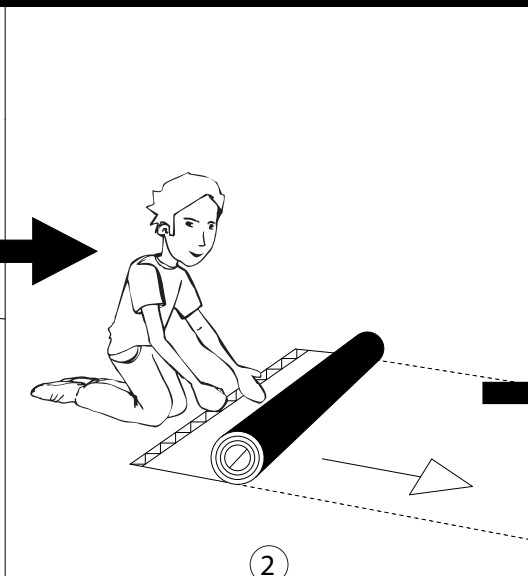
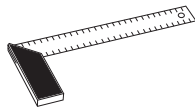
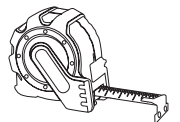
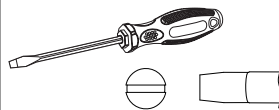
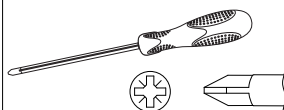
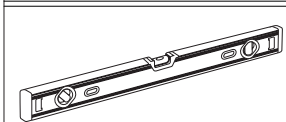
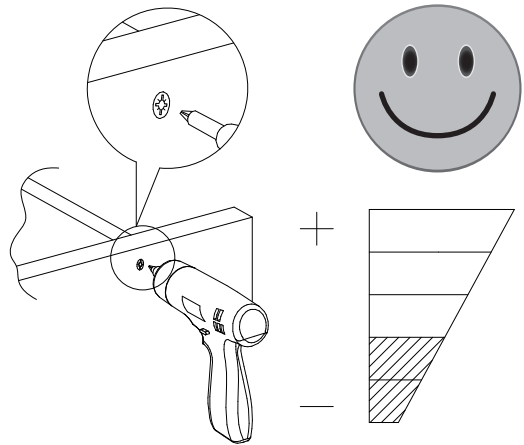
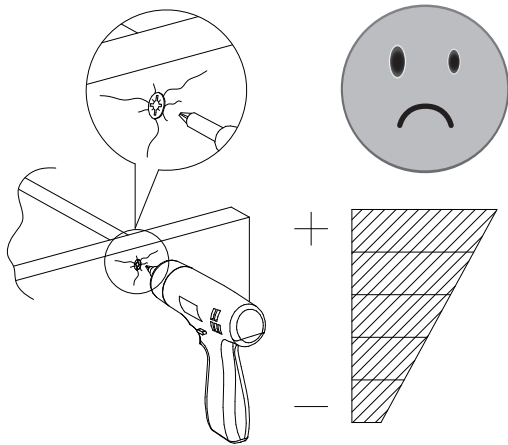
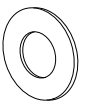
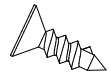
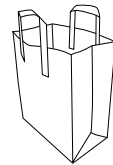
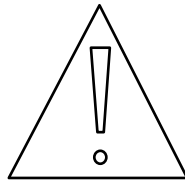

DESIGNATION	LONGUEUR	LARGEUR	EPAISSEUR	N° PIECE	QTE	COLIS
Dessous	642	400	18	01	1	1
Côté gauche	1860	399	38	02	1	2
Intermédiaire fixe	564	363	16	04	2	1
Derrière	1860	250	16	06	1	2
Côté droit	1860	399	38	07	1	3
Dessus	642	400	38	08	1	1
Tablette fixe	564	340	18	09	1	1
Porte	616	558	18	10	1	1
Tablette de niche	564	363	18	19	2	1
Derrière de porte	580	340	16	26	1	1

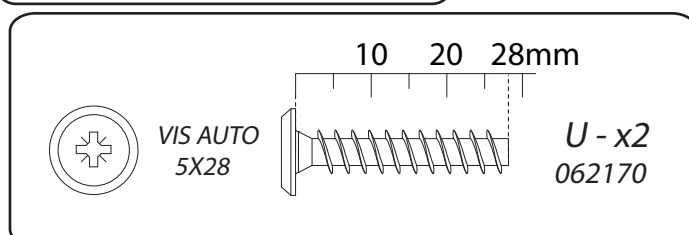
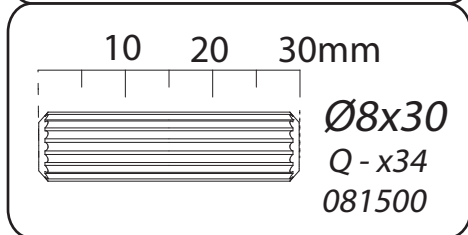
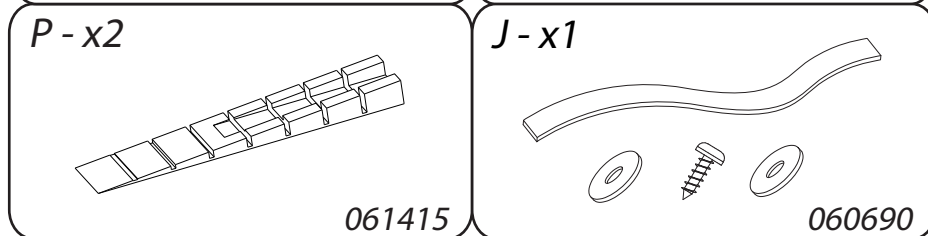
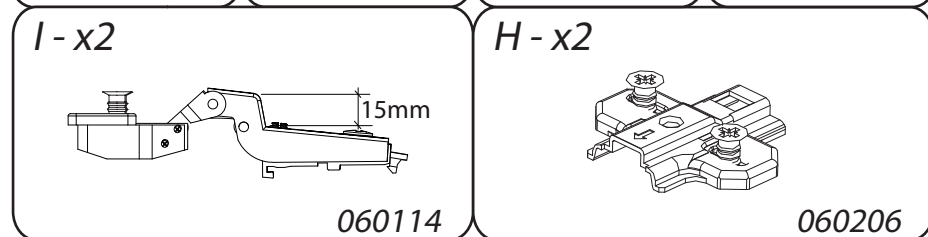
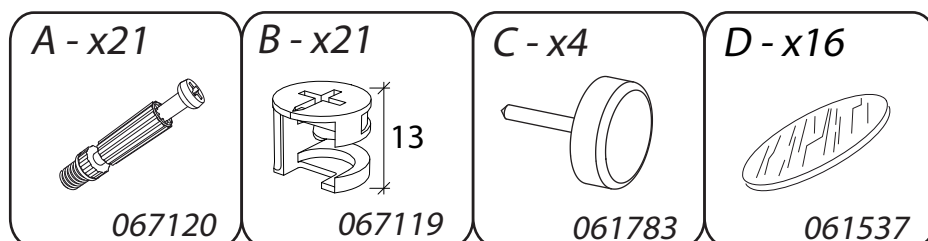

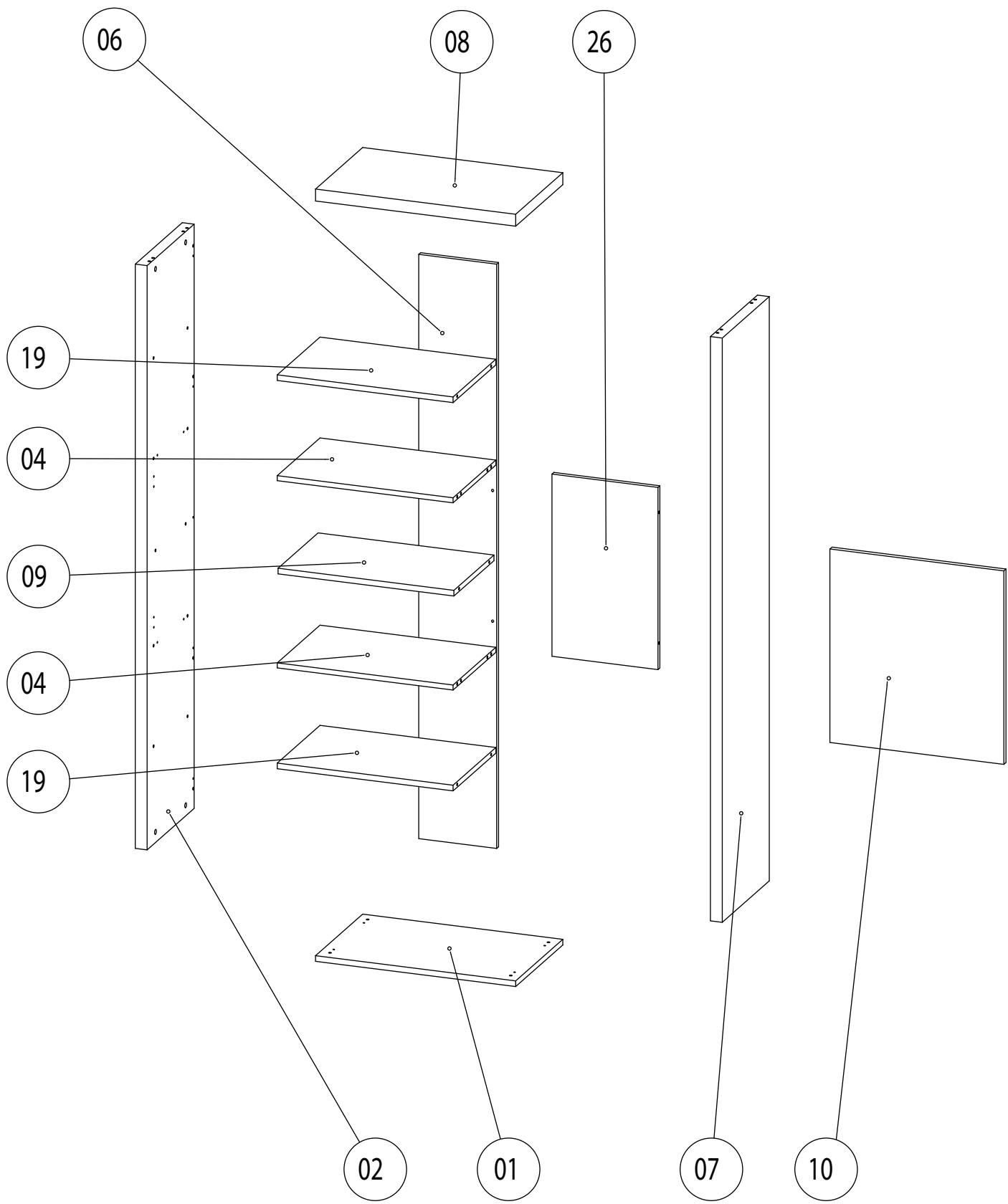

1

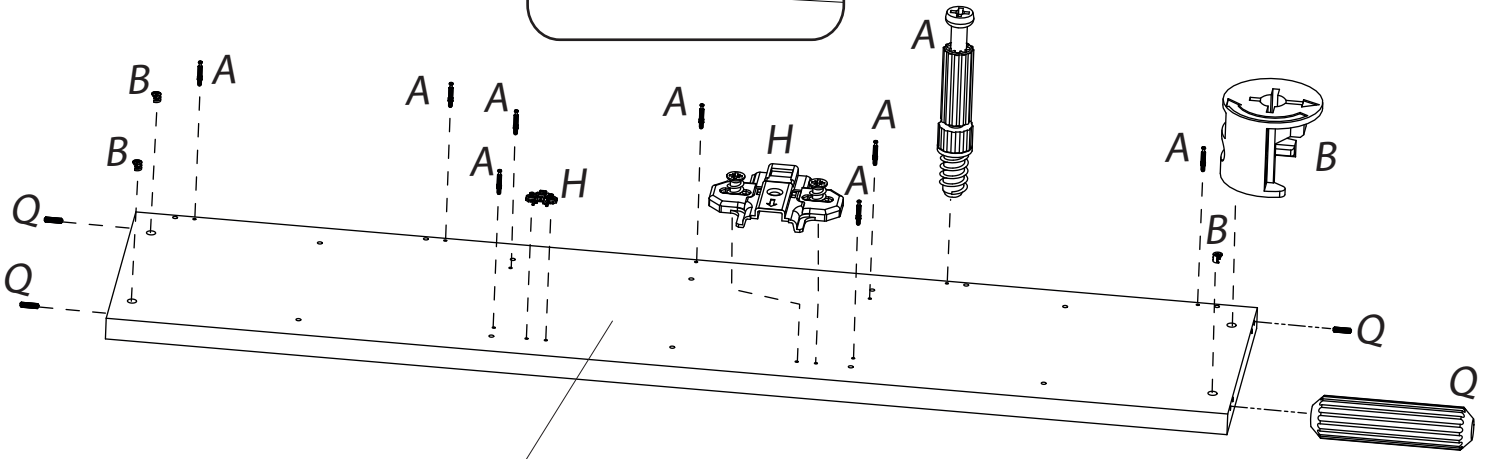
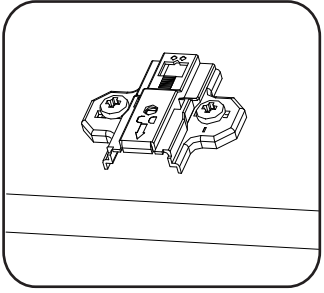
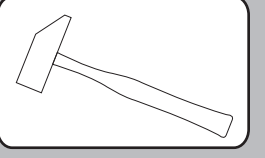
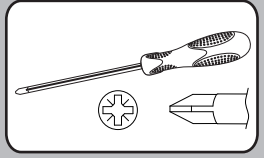
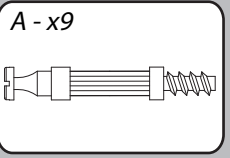
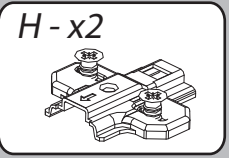
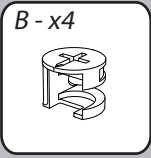
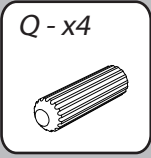

02

2

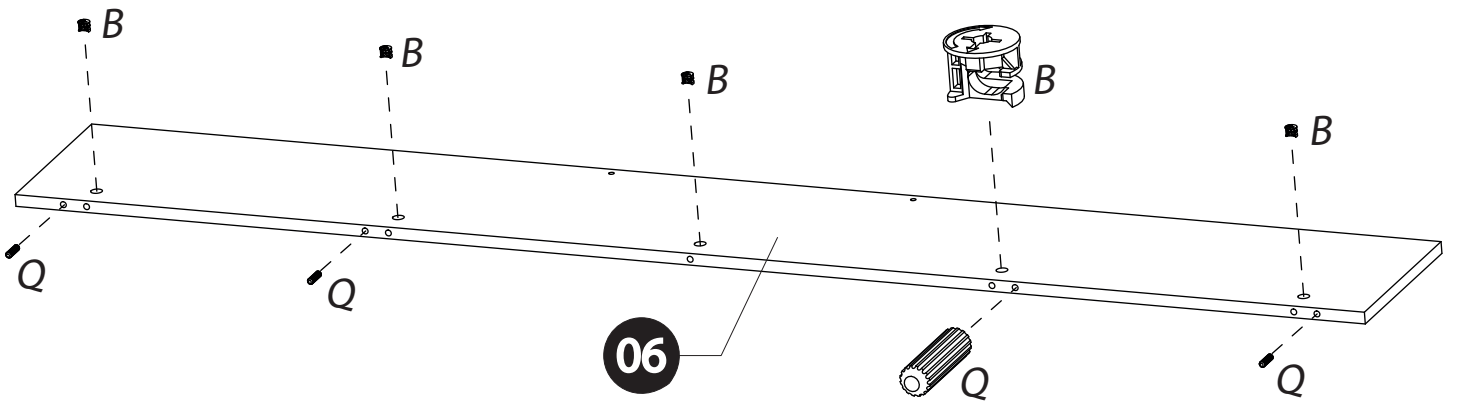
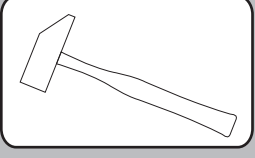
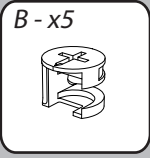
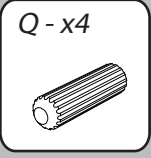

06

3

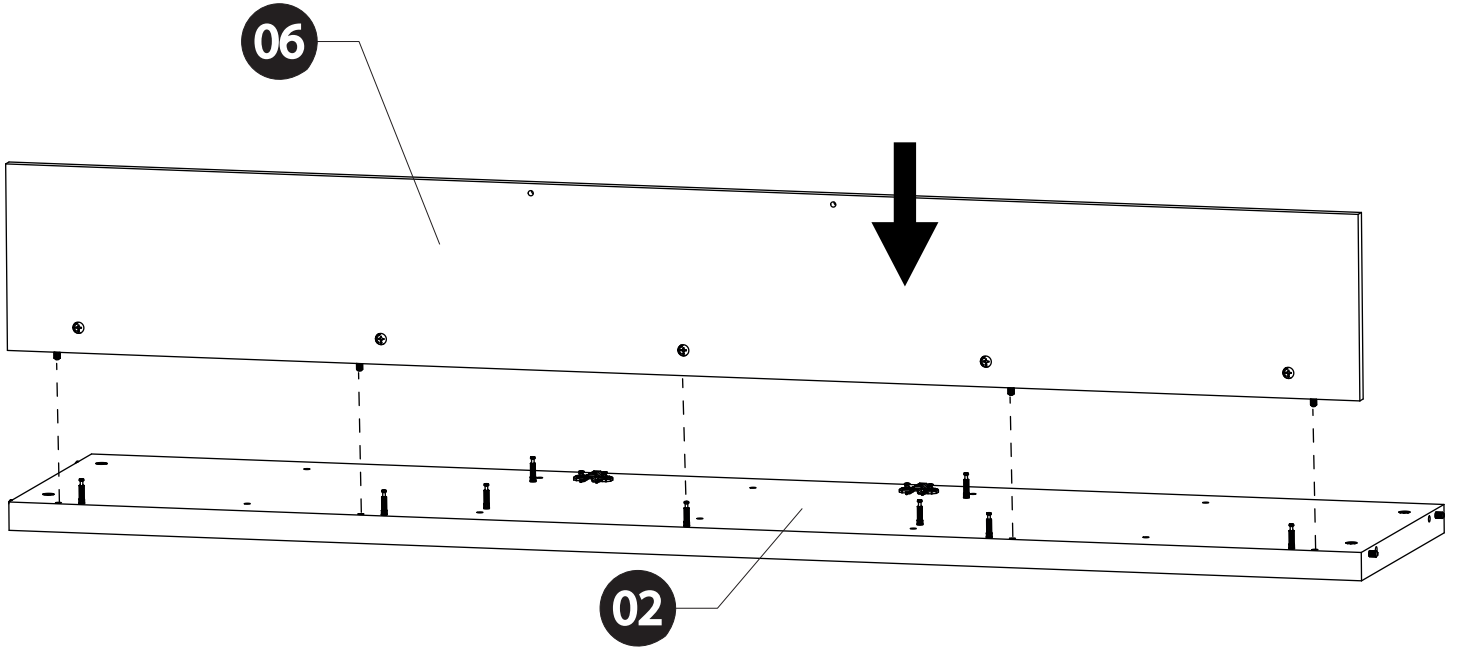
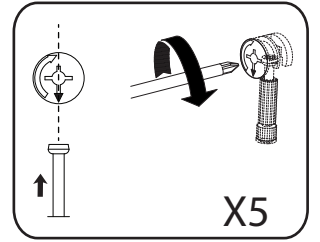
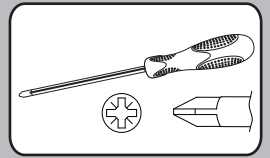

4

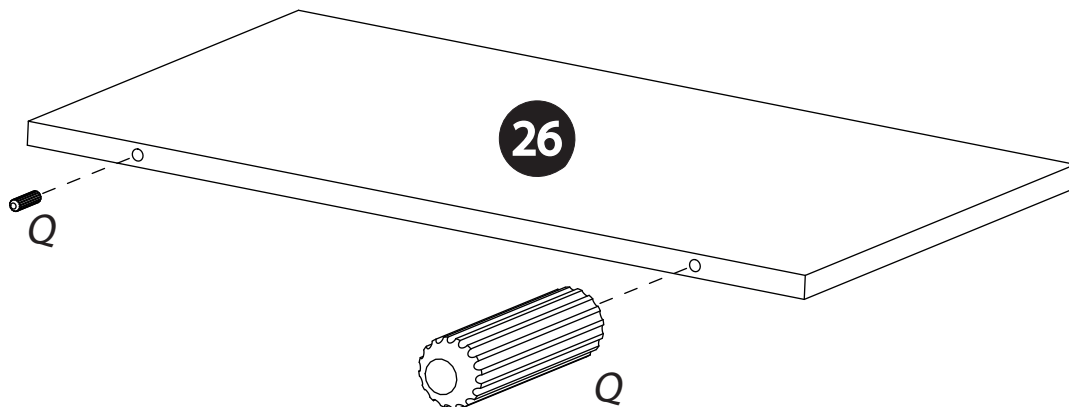
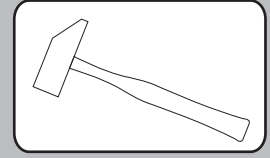
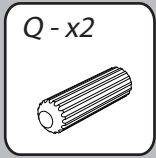

5

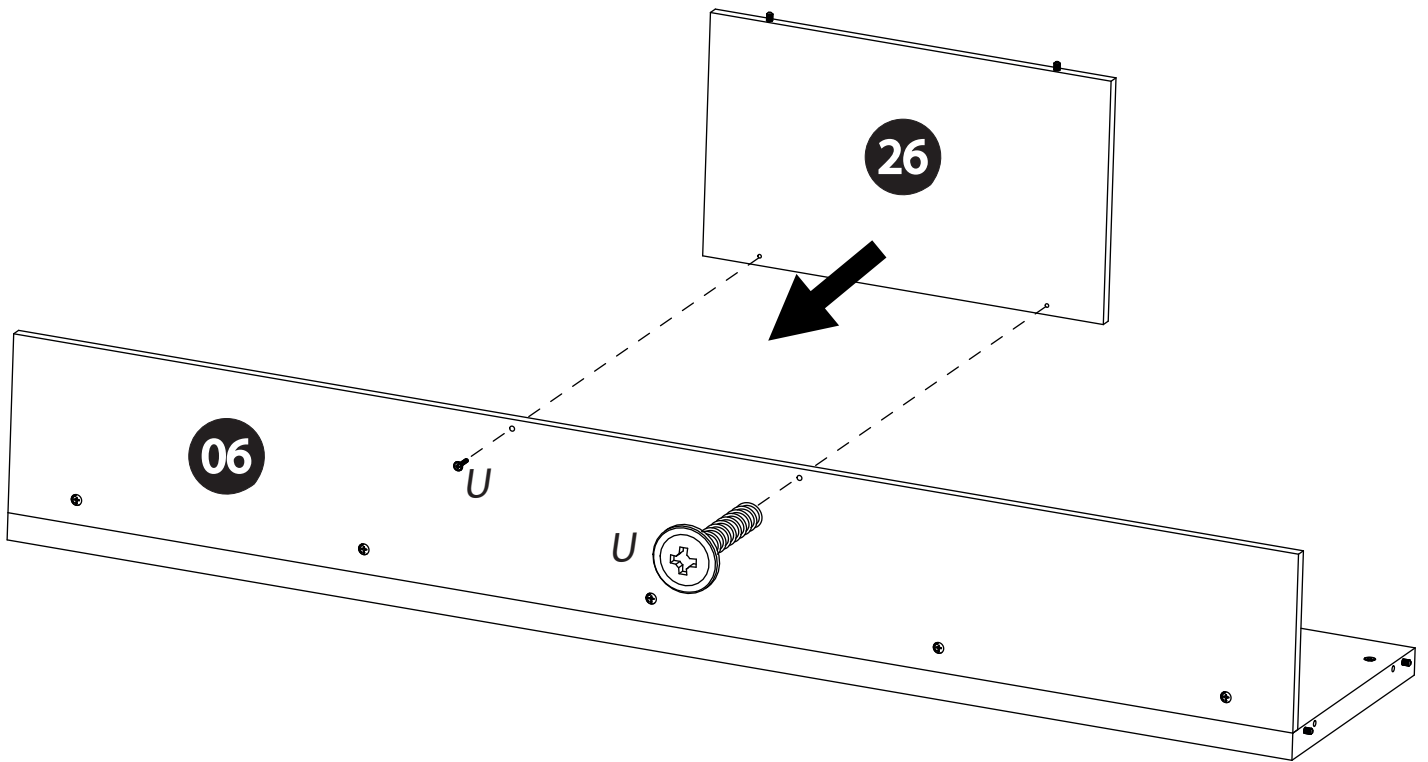
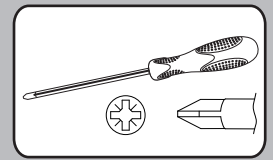
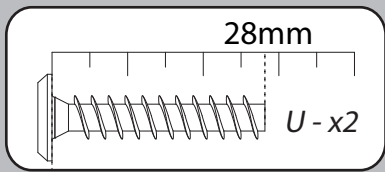

6

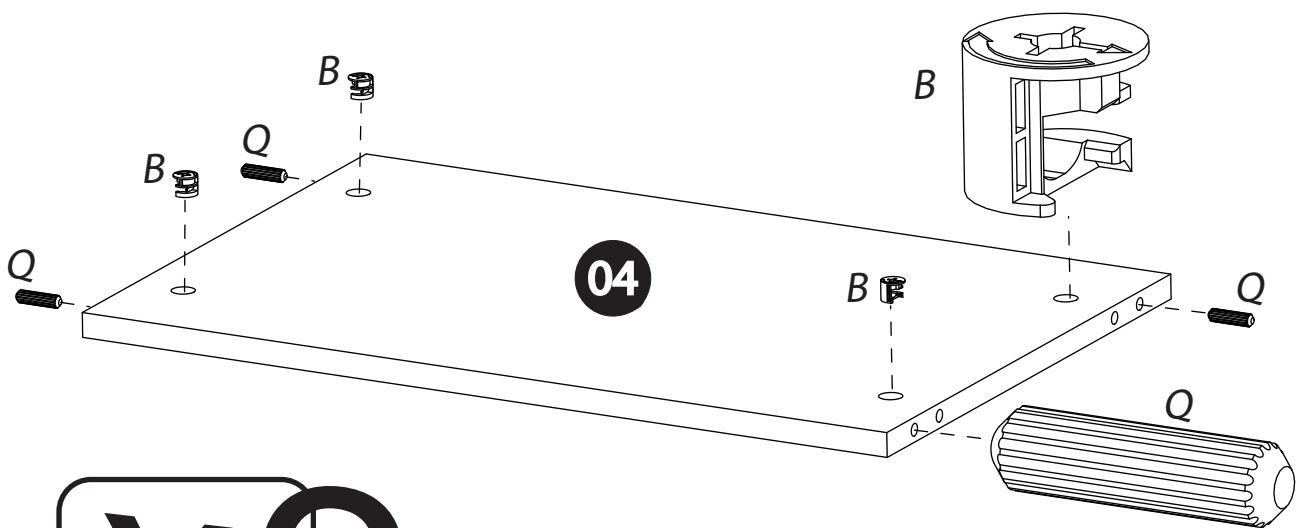
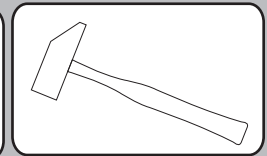
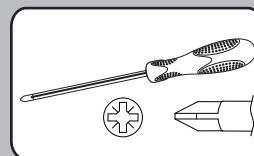
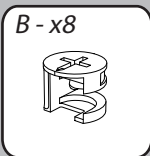
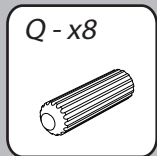

X2

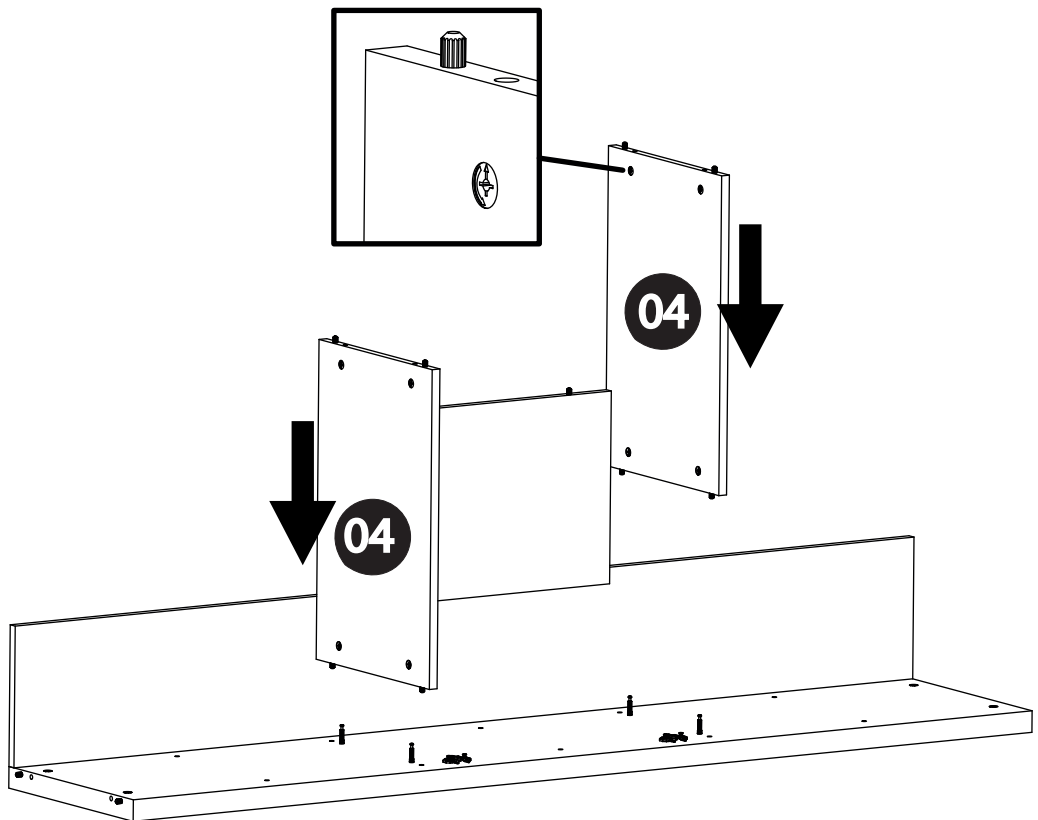
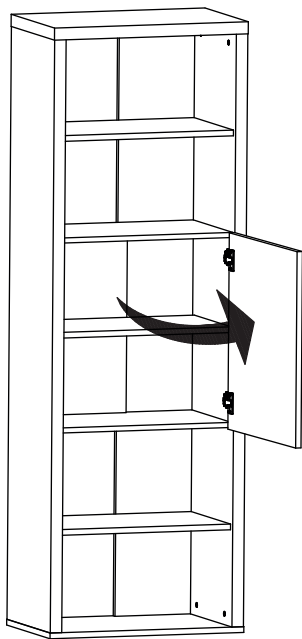
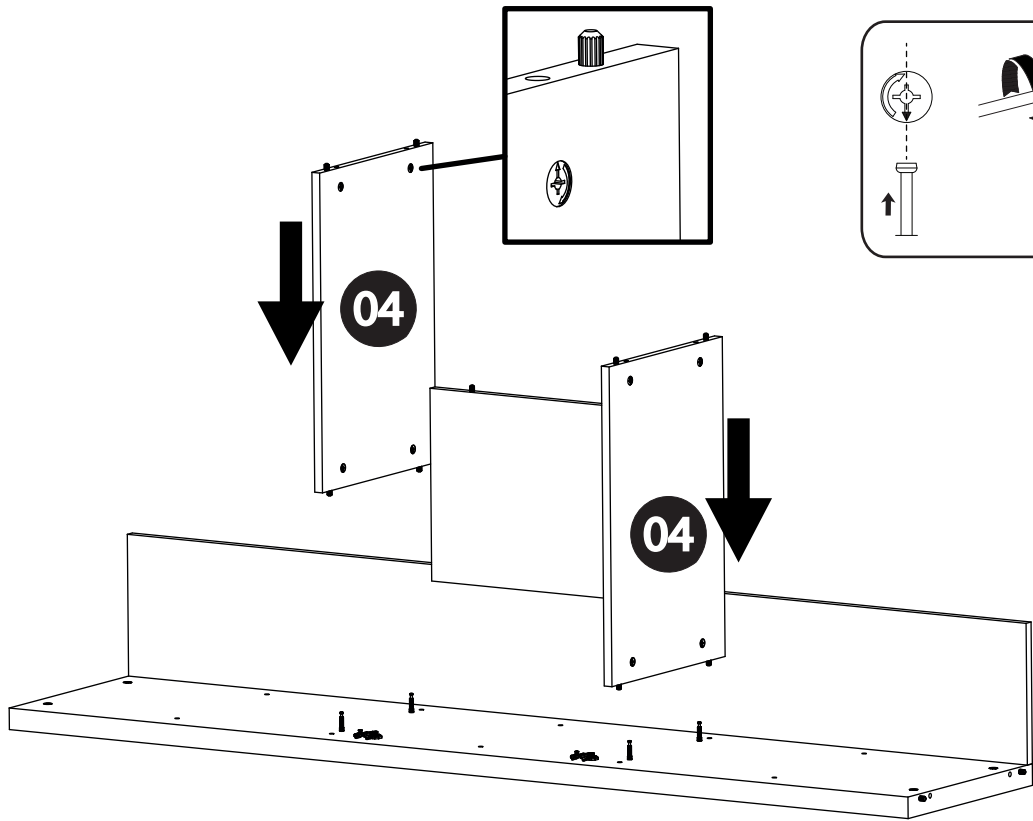
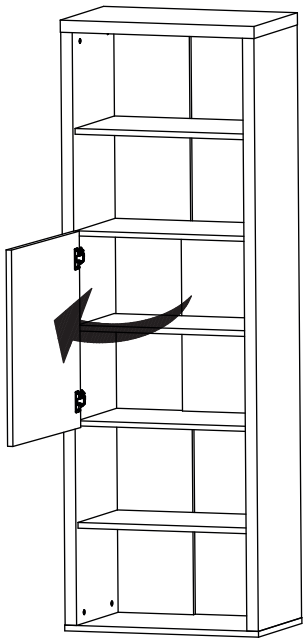
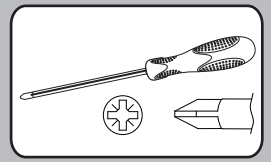

8

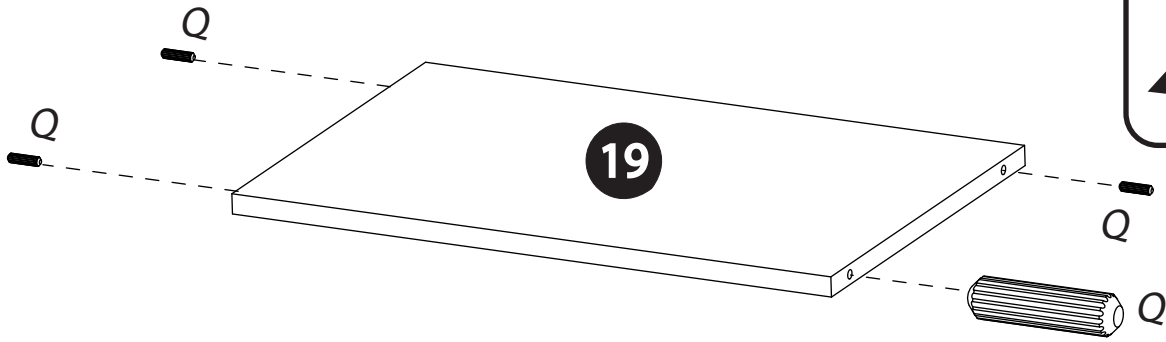
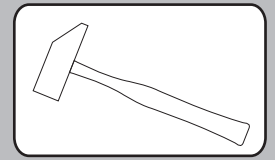
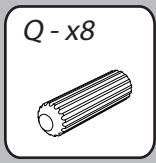

9

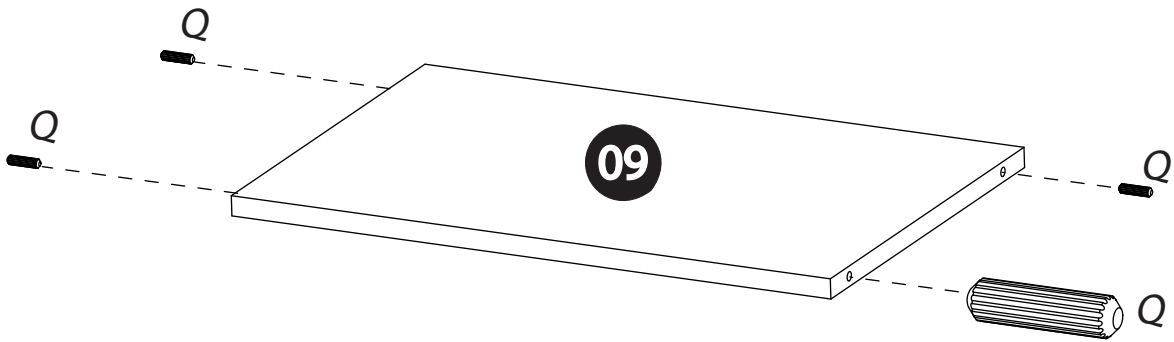
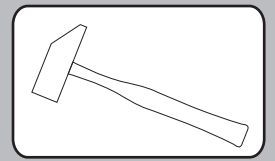
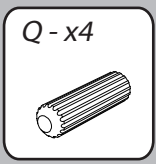

10

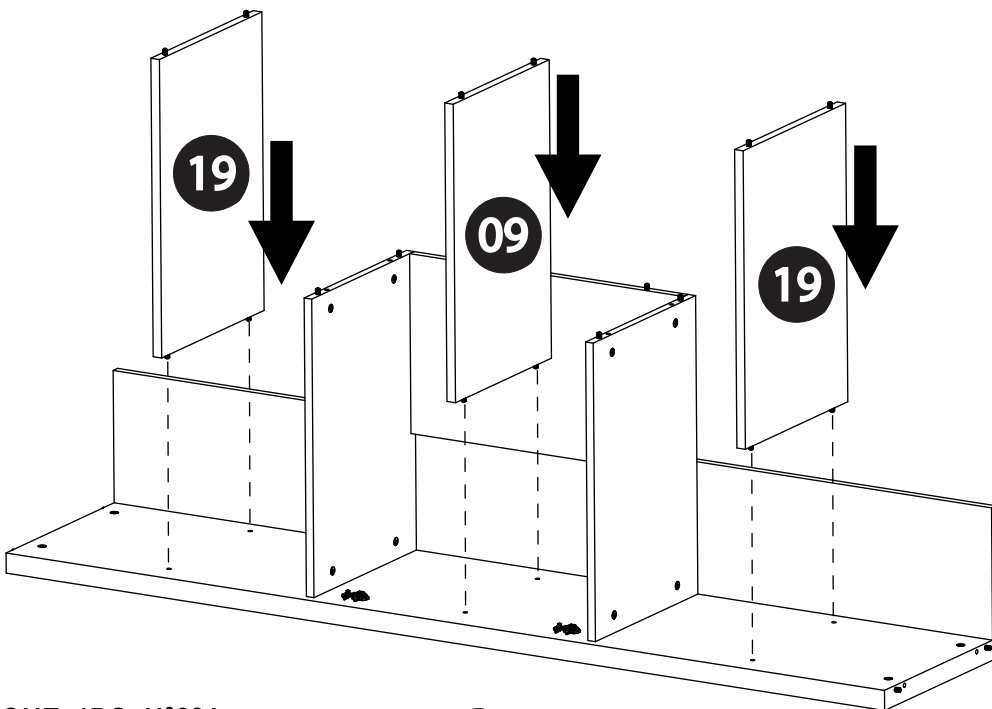

11

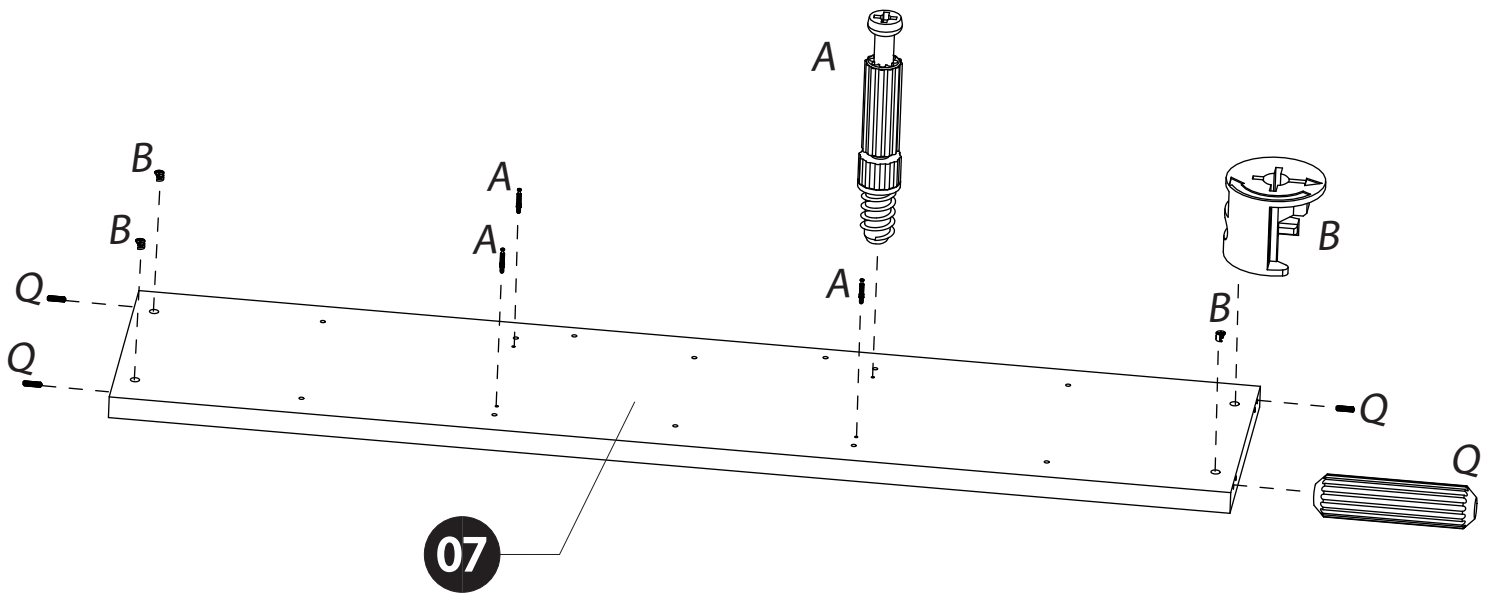
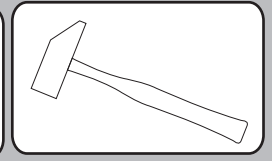
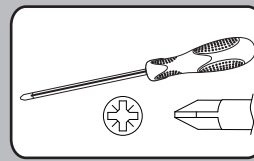
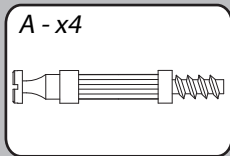
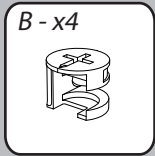
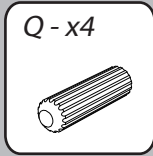

12

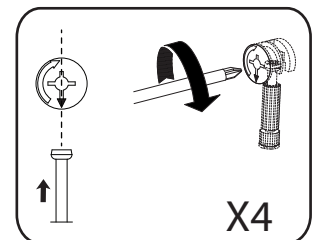
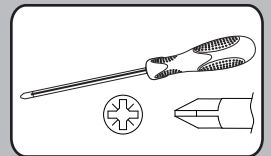

07

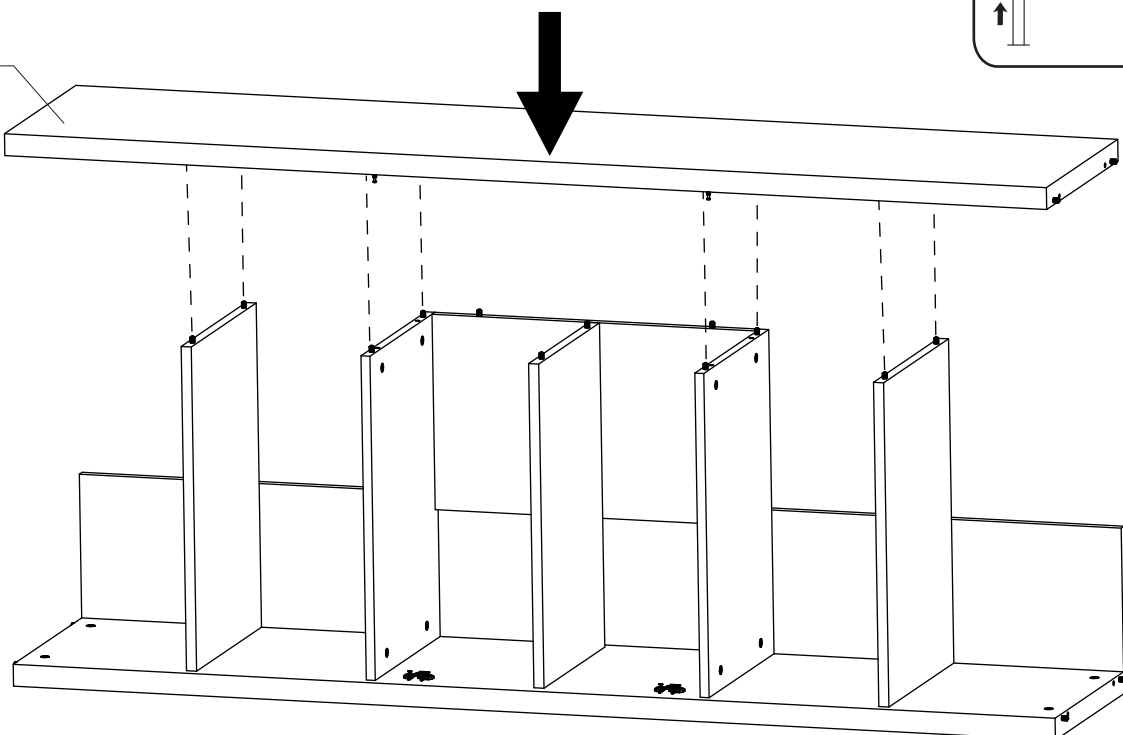

10

CASTEL BIBLIOTHEQUE 1PO N°03A

13

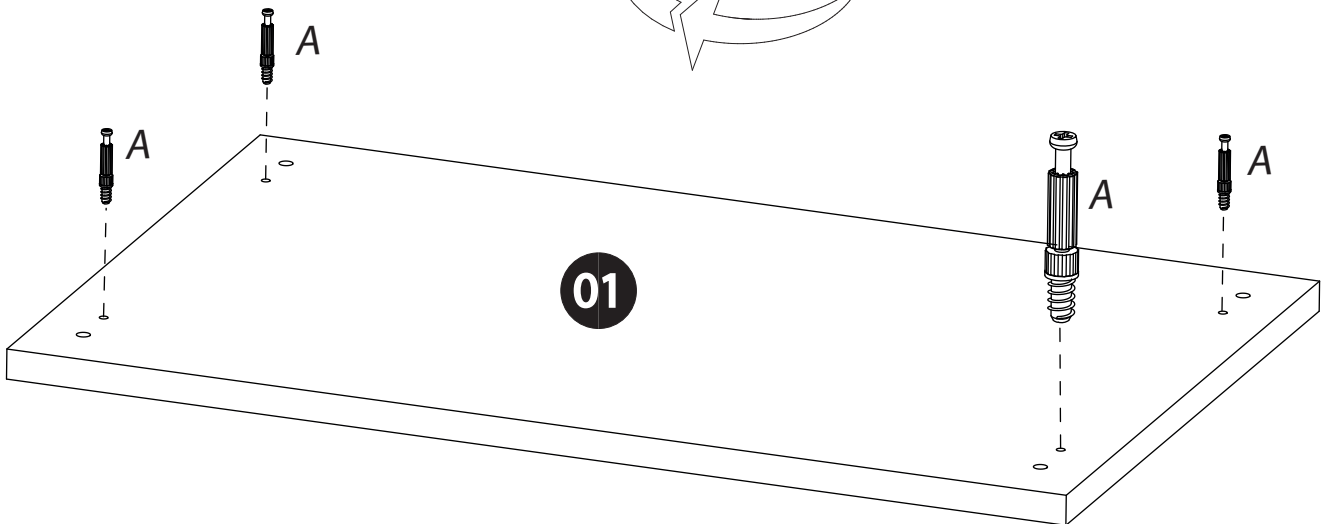
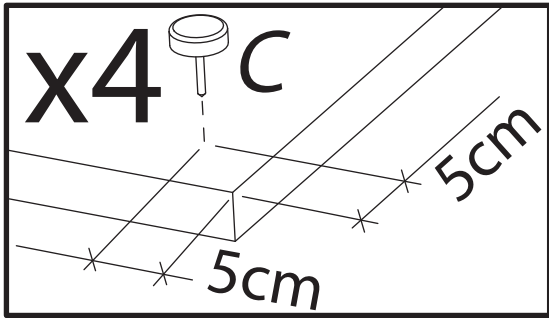
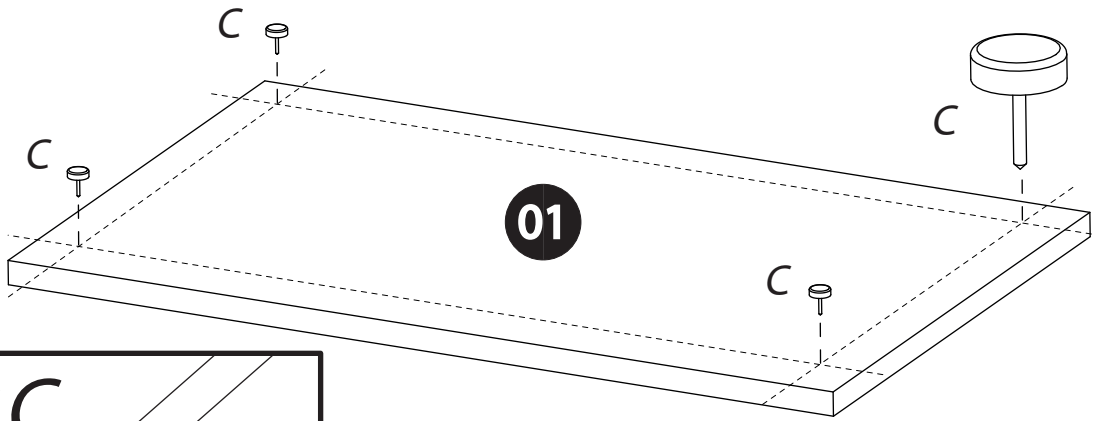
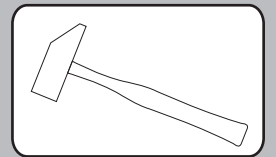
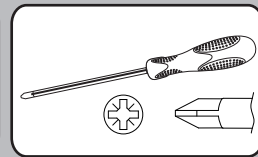
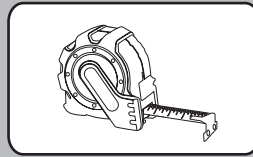
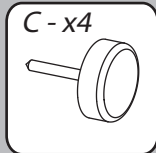
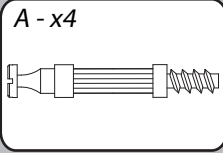

14

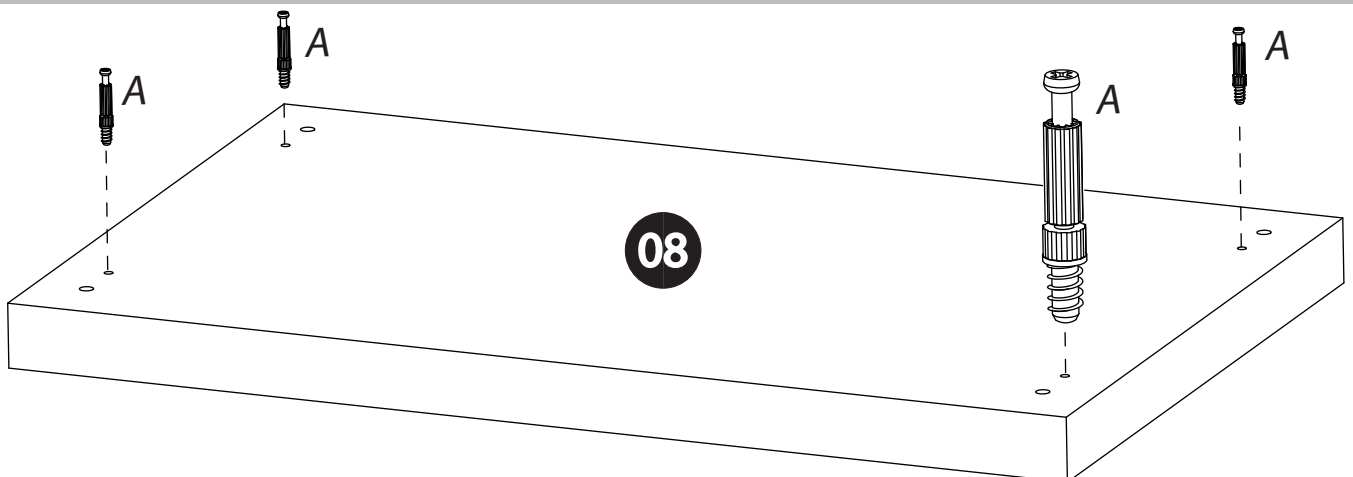
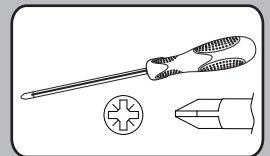
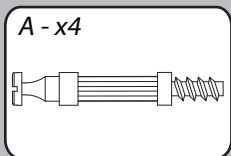

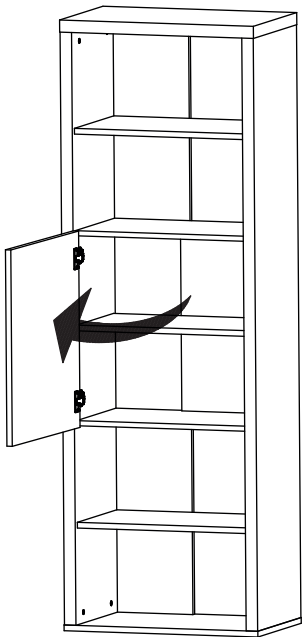
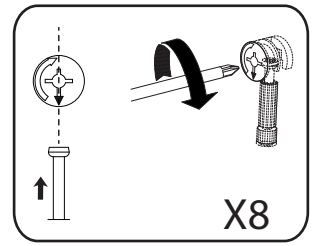
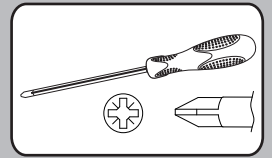

08

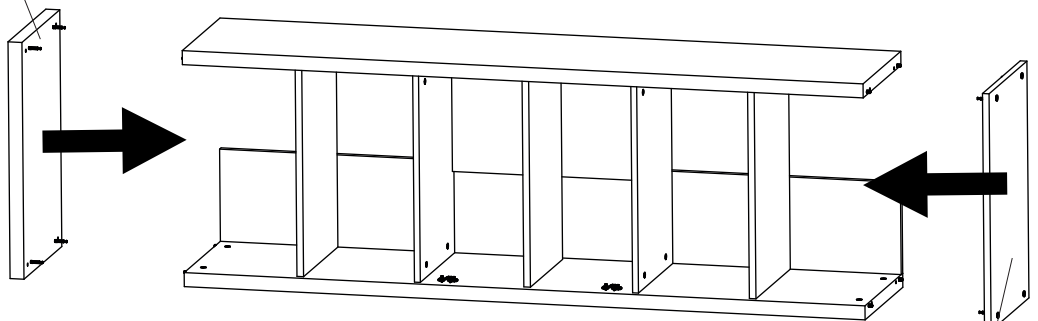

01

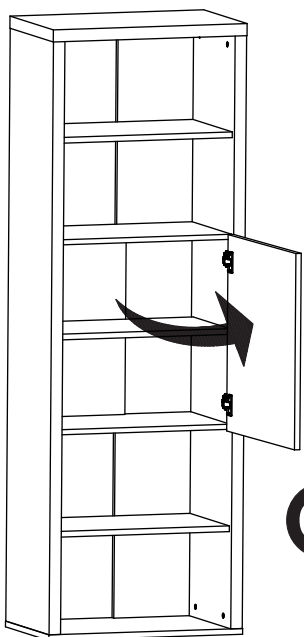

01

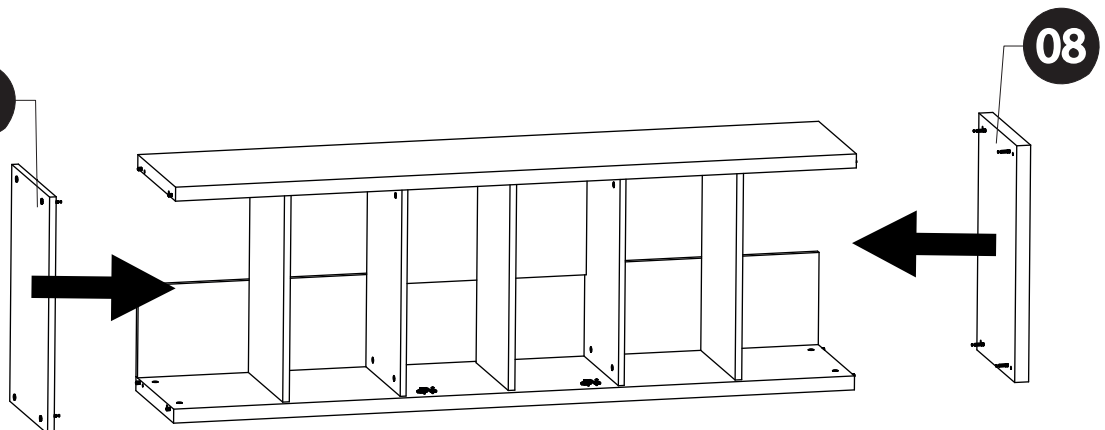

08

16

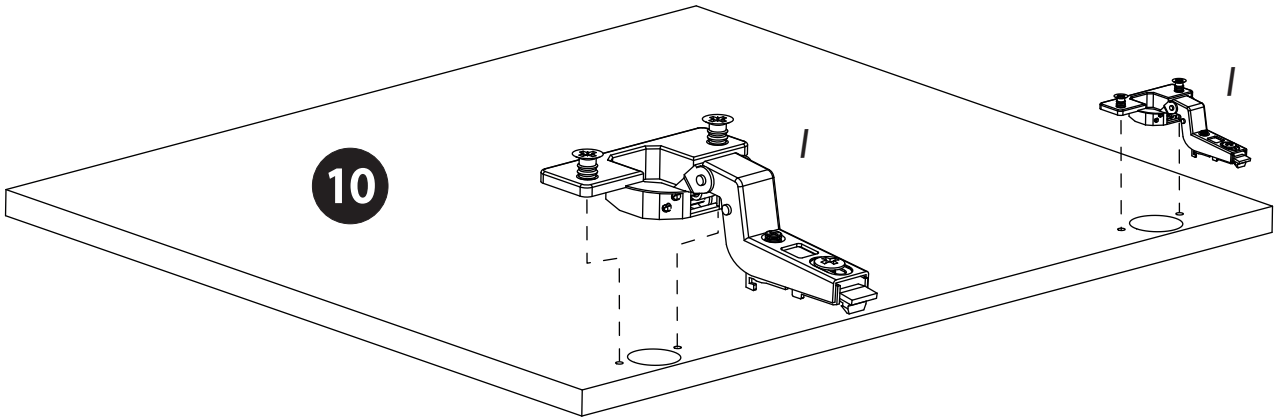
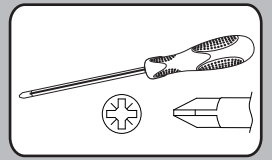
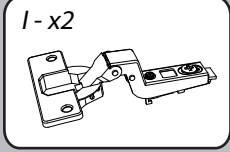

17

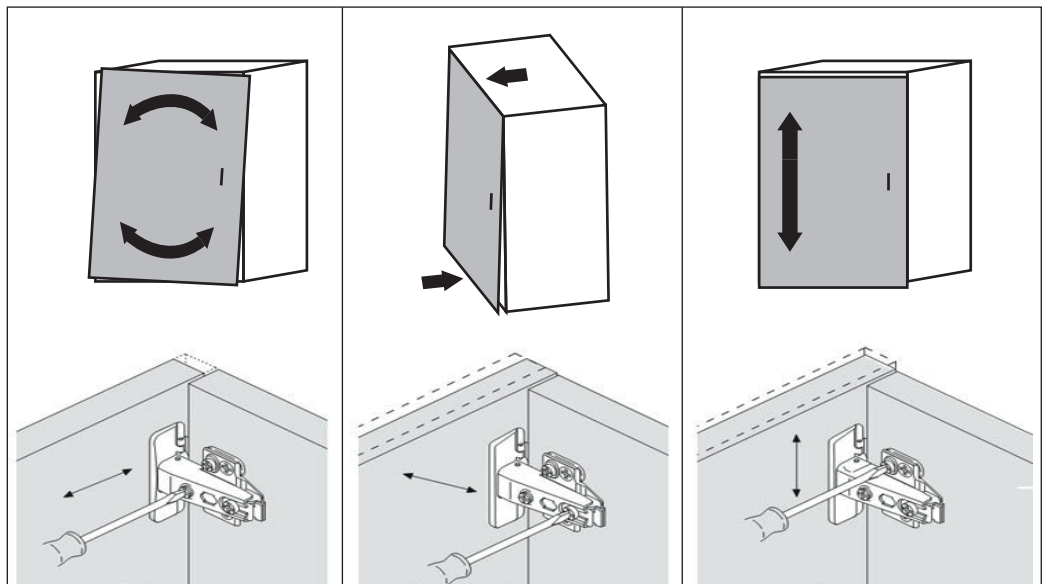
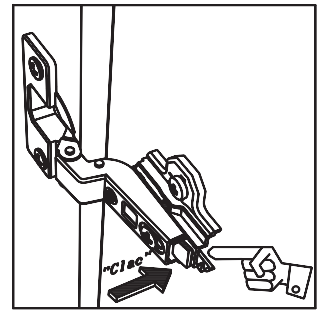
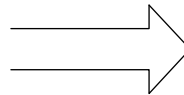
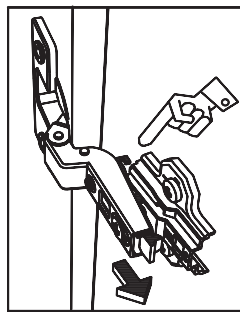
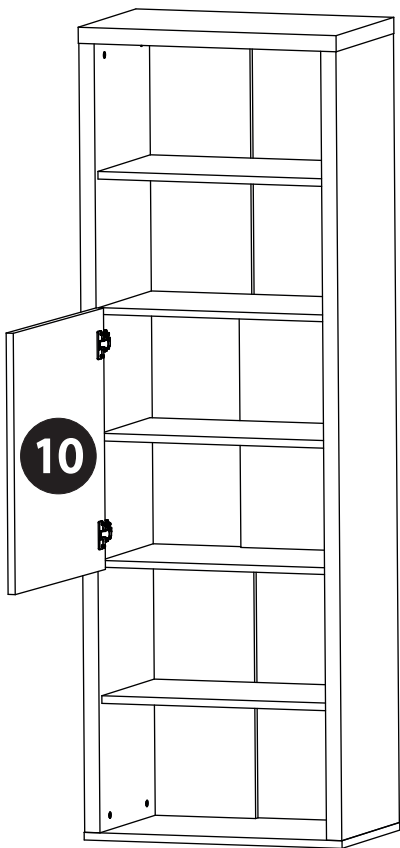
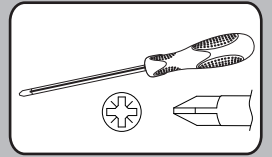

D-x16



P-x2

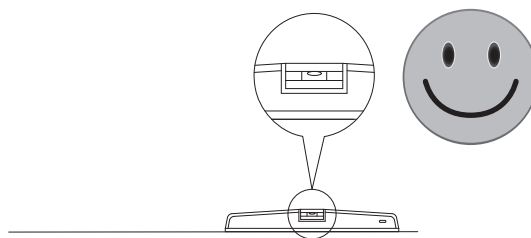
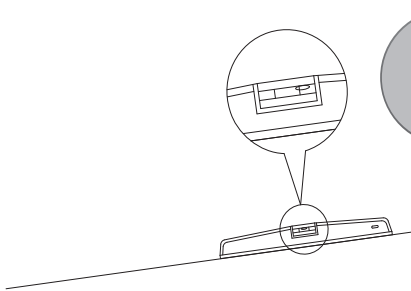
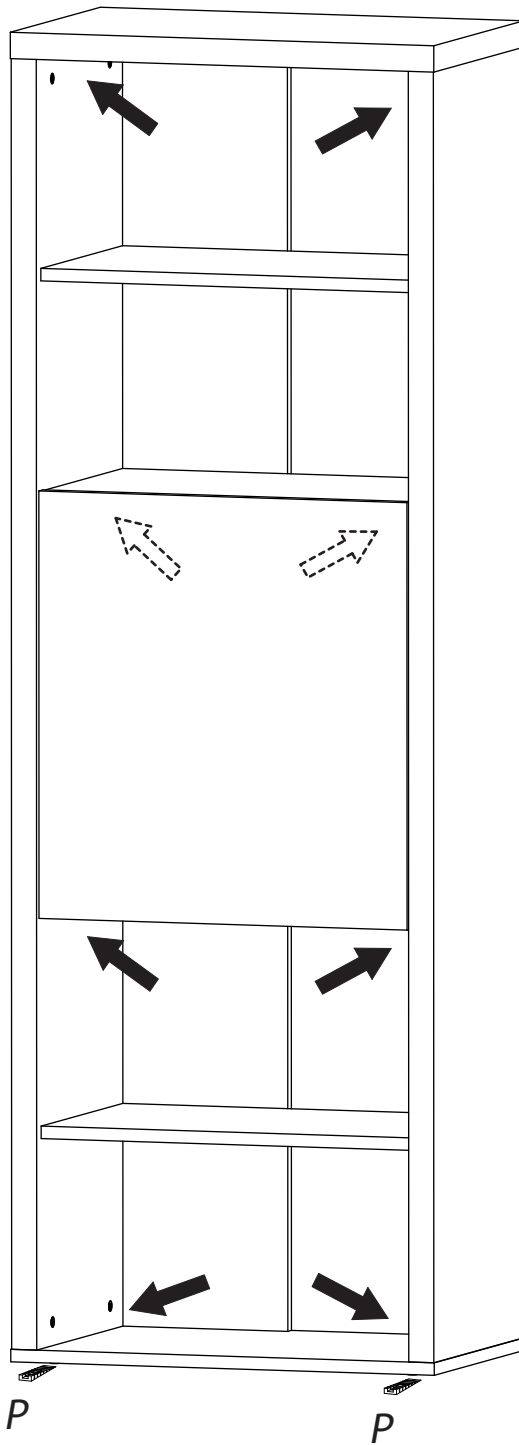
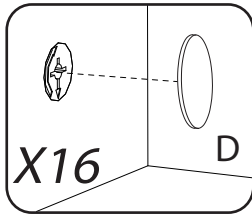
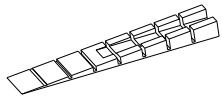

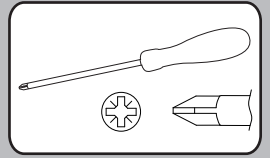
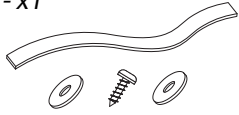

FRANCAIS: Pour votre sécurité il est impératif de fixer votre meuble au mur.
 Pour cela tous les meubles hauts disposent d'un dispositif d'accrochage, disponible à l'intérieure de votre colis.
 Si tel n'est pas le cas, veuillez en faire la demande auprès de votre revendeur.
 Cela empêche toute chute accidentelle du meuble.

ENGLISH: For your safety it is compulsory to fix your furniture to the wall.
 For this reason, all the high cabinets have a hanging system, available inside your package.
 If this is not the case, please contact your reseller.
 This prevents any accidental falling of the furniture.

DEUTSCH: Zu Ihre Sicherheit muss Ihre Möbel an der Wand befestigt.
 Aus diesem Grund verfügen alle Hochschränke über eine Aufhängevorrichtung, die in der verpackung steht.
 Falls nicht, bitte verwenden sie sich an ihren Händler.
 Es vermeidet jede zufällig fallen.

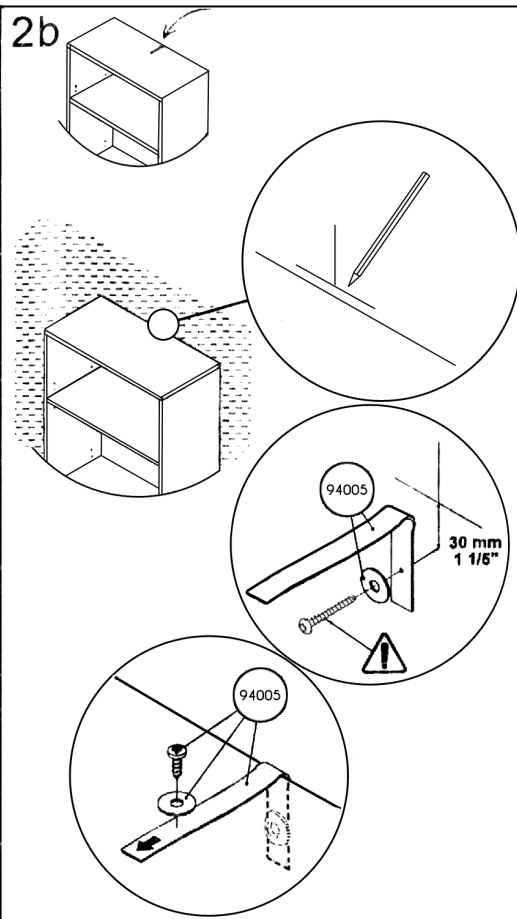
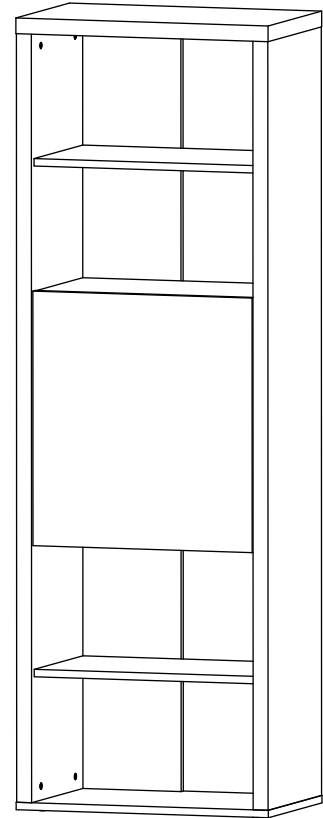

FRANCAIS
IMPORTANT: La vis fournie avec le dispositif anti-bascule est destinée à fixer le dispositif dans le meuble.
 Pour la fixation au mur, compléter par une vis adaptée au support mural.
 En cas de doute, contacter un magasin de bricolage.

ENGLISH
IMPORTANT: The screw supplied together with the anti-topple bracket is to be used only for fixing the anti-topple bracket to the furniture.
 In addition to this, you will need to choose a screw or fitting which is suitable for securing the bracket to the kind of walls you have. If you are unsure about what type of screw to use contact your local hardware store.

DEUTSCH
WICHTIG: Die dem kippschutz beigelegten schrauben sind ausschließlich für die befestigung des kippschutzes am möbelstück vorgesehen. Für die befestigung des kippschutzes an der wand benötigen sie zusätzlich schrauben oder beschläge, die zur beschaffenheit der wand passen. Falls sie nicht sicher sind, welche art von schrauben geeignet sind, wenden sie sich bitte an den fachhandel.



- **FRANCAIS** - Recommandations de démontage :

En cas de déménagement, il convient de procéder au démontage de votre meuble, en ôtant toute la visserie.

- **ENGLISH** - Disassembly advices:

In case of moving, it is needed to dismantle the furniture removing the fittings.

- **DEUTSCH** - Empfehlungen für die Demontage:

Bei Transport bitte alle Beschläge demontieren.



"Les meubles contenant des panneaux à base de bois (panneaux de particules, panneaux de fibres, contreplaqué...) peuvent émettre des substances polluantes dans l'air intérieur. Il est ainsi recommandé, après l'installation du meuble dans son logement, d'aérer fréquemment la pièce concernée pendant au moins quatre semaines afin de réduire son exposition aux polluants émis par le meuble."