

THANK YOU SO MUCH FOR PURCHASING OUR PRODUCT. IF YOU HAVE ANY TROUBLE PUTTING YOUR KIT TOGETHER OR MISSING PIECES PLEASE CONTACT US.

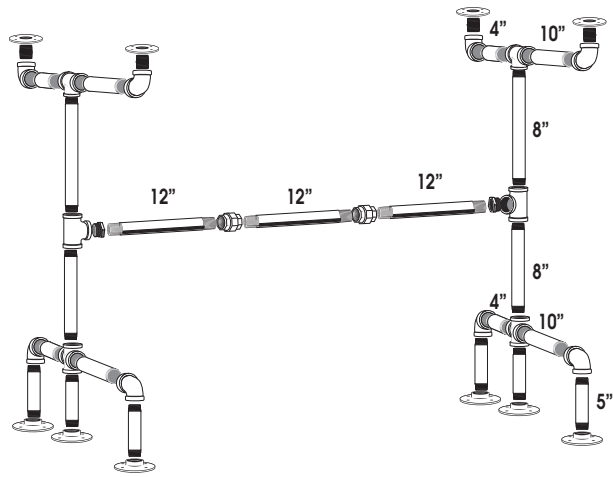

This kit is made of industrial grade authentic pipe. It is coated in oil post production to prevent rust. The kit should be cleaned and sealed to prevent rusting. See Clean and Seal sheet for more information on cleaning and sealing your pipe kit.

1. Connect 2 X ELBOWS, 2 X FLANGES, 2 X CONNECTORS, 1 X 4" PIPE, 1 X 10" PIPE, 1 X TEE, 1 X 8" PIPE into the top part of the leg as shown in box 1. Repeat with other side.
2. Connect 2 X ELBOWS, 3 X FLANGES, 2 X 5" PIPE, 1 X 4" PIPE, 1 X 10" PIPE, 1 X CROSS, 1 X 8" PIPE into the top part of the leg as shown in box 2. Repeat with other-side.
3. Connect a 2 X BUSHINGS, 3 X 12" PIPE, 2 X UNIONS to the legs in part 2. Screw each 12" PIPE as tight as you can by hand into the first UNION. Then screw on the 2nd UNION and 3rd PIPE. Screw this into the TEE. Loosen the UNION and turn the UNION bolt to screw PIPE into the other TEE and tighten UNION.
4. Connect the 2 tops to the bottom of the desk.
5. Loosen flanges to level desk and screw into your desktop.

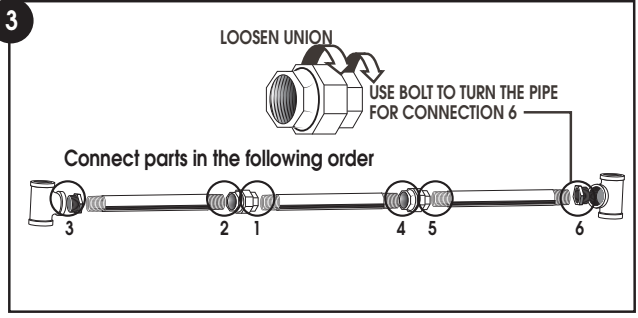
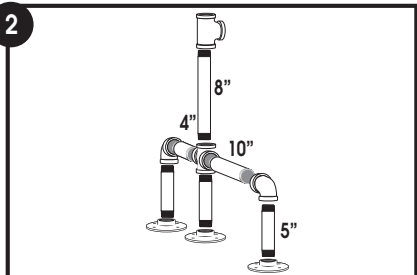
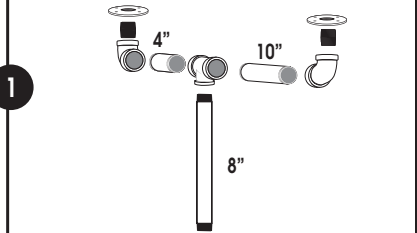

**A - 10 X FLANGES**

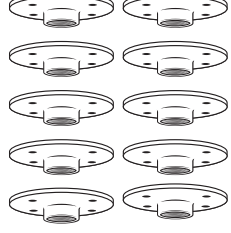

**B - 4 X 8" PIPE(3/4")**

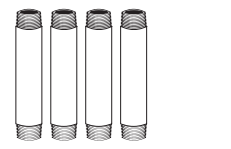

**C - 4 X 10" PIPE(3/4")**

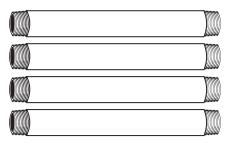

**D - 4 X 4" PIPE(3/4")**



**E - 6 X 5" PIPE(3/4")**

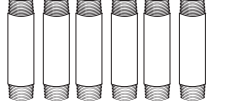

**F - 2 X BUSHINGS**



**G - 4 X -TEES**

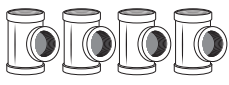

**H - 2 X CROSS**



**I - 8 X ELBOW(3/4")**

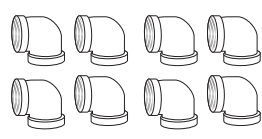

**J - 4 X CONNECTOR**



**K - 2 X UNIONS**

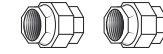

**L - 3 X 12" PIPE**



**M - 16 X 3/4" SCREWS**

**RECOMMENDED TOOLS**

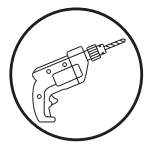

RECOMMENDED FOR ATTACHING LEGS TO TABLE TOP