

Outdoor Chairs Set

SKU WHOF2316-CH2

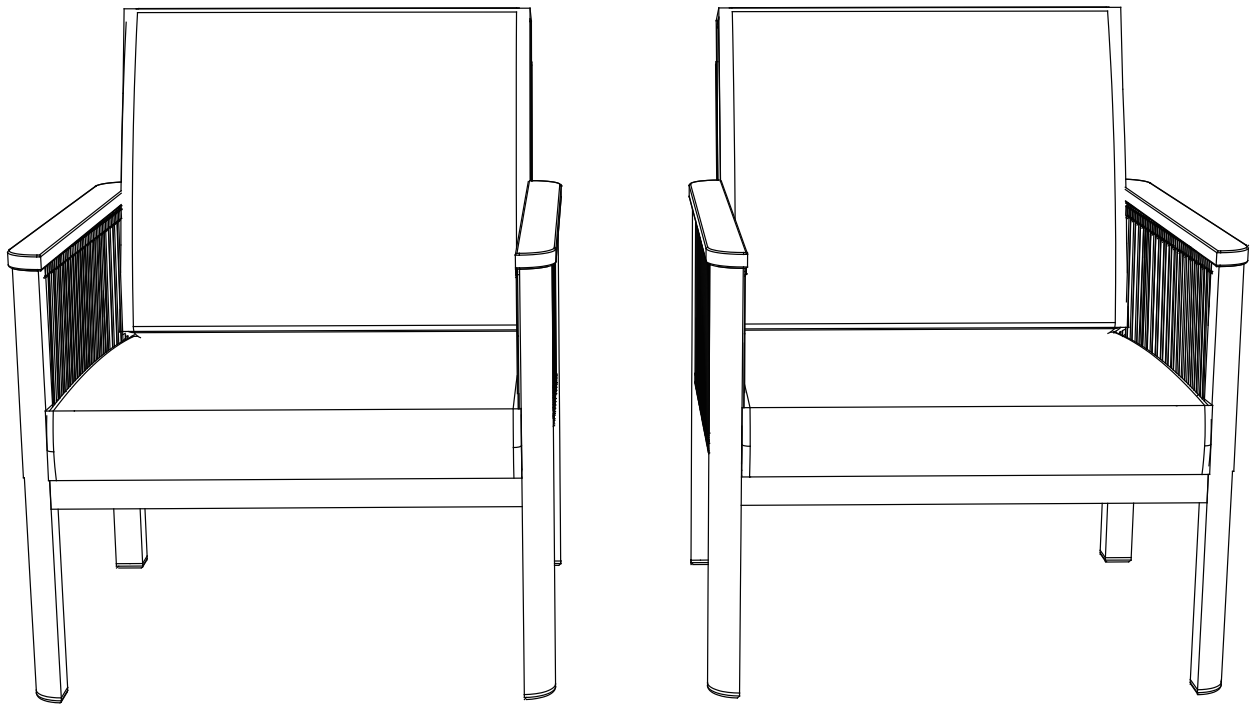

ASSEMBLY INSTRUCTIONS



60 min. assembly

2 person

*The estimated assembly time may vary depending on the individual.

Hey, there

Now is assembly time!

Deeeeep breathe.... and again....
Tools ready,
Easy peasy!

Estimated



60 min. assembly
2 person

Tools Required

- Allen Wrench (included)

important: Cautious when you use power tools

Need Help?

Call us at +1 909 548 6688
Email customerservice@luxenhome.com
Submit a ticket on www.luxenhome.com/help

Thank you for purchasing this LuxenHome product. This product has been manufactured with the highest standards of safety and quality.

PLEASE READ ALL INSTRUCTIONS CAREFULLY BEFORE ASSEMBLY.

Unpack all parts from the packaging inside the carton to ensure there are no missing or damaged parts. Lay out all the parts on a clean, flat, and soft surface to prevent scratches. Refer to the steps provided as assembling guide.

Do not attempt to assemble or use the product if any parts are missing or damaged.

REMINDERS

SAFE USAGE IS KEY

Your well-being is our top priority when you use our product. Please prioritize your safety by diligently following the assembly guidelines and inspecting the product carefully both when it arrives and before each use.

Please be aware that LuxenHome and Winsome House, Inc. cannot be held liable for any injuries or fatalities that occur due to not adhering to the provided instructions or misuse of the product.

DO NOT MODIFY

Our products undergo rigorous testing to ensure they meet established safety standards before being released for sale. Altering the product in any way can lead to serious safety concerns, for which LuxenHome cannot assume responsibility.

What's in the box

Parts

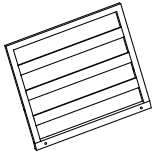

A X 2
Back panel

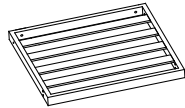

B X 2
Seat panel

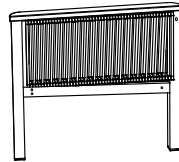

C X 2
Right armrest

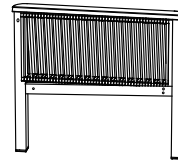

D X 2
Left armrest

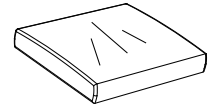

E X 2
Seat cushion

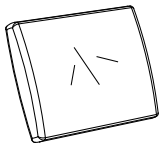

F X 2
Back cushion

Hardware & Accessory

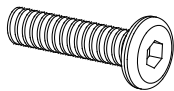

1 X 13
M6 x 30mm

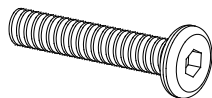

2 X 5
M6 x 35mm

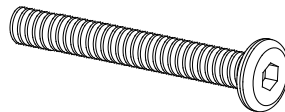

3 X 5
M6 x 55mm



4 X 21
Φ 6mm



5 X 1
4mm

Assembly

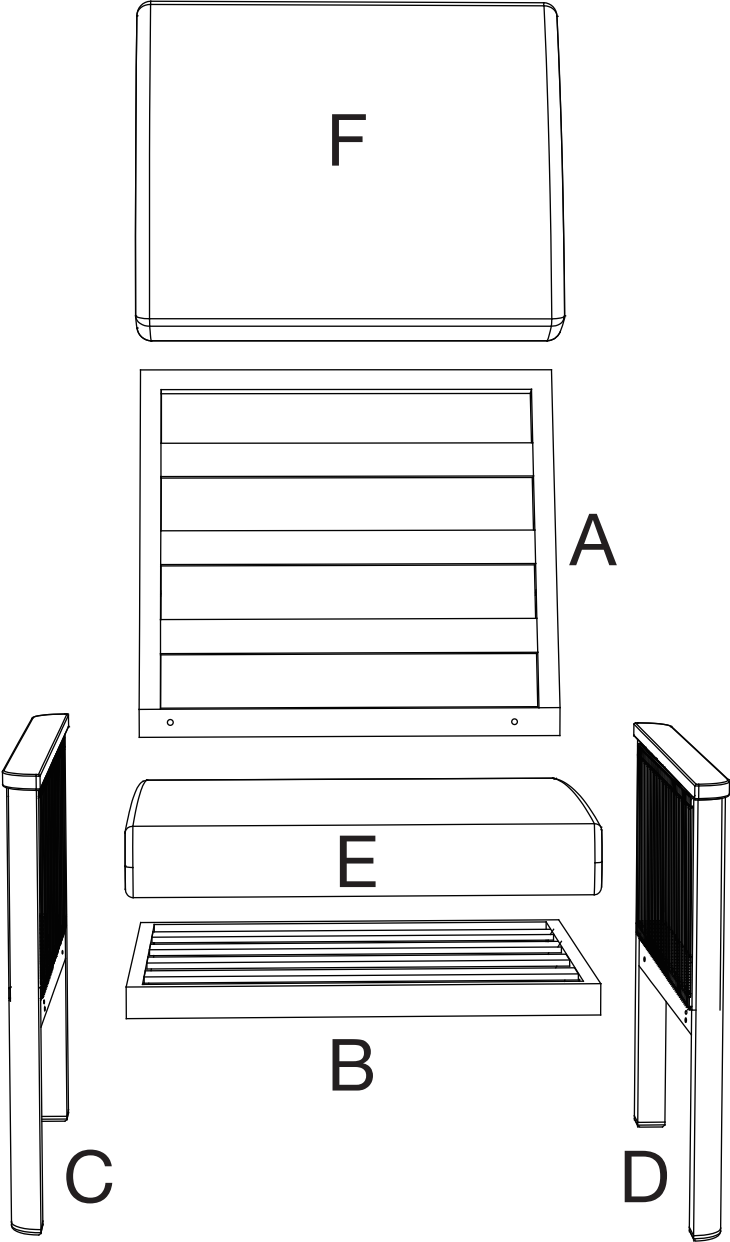

Step 1

Connect the Parts (C) and (D) to the Part (B) as shown.

① X 6	④ X 6	⑤ X 1
M6 x 30mm	Ø6mm	4mm

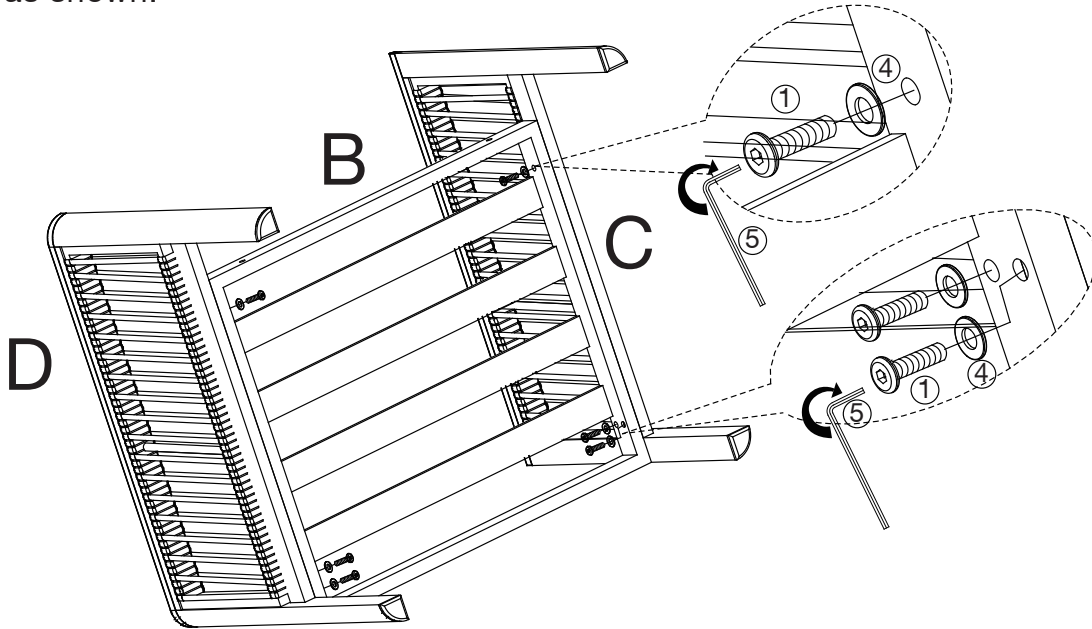

Step 2

Connect the Part (A) to the Parts (C) and (D) and (B) as shown.

② X 2	③ X 2	④ X 4	⑤ X 1
M6 x 35mm	M6 x 55mm	Ø6mm	4mm

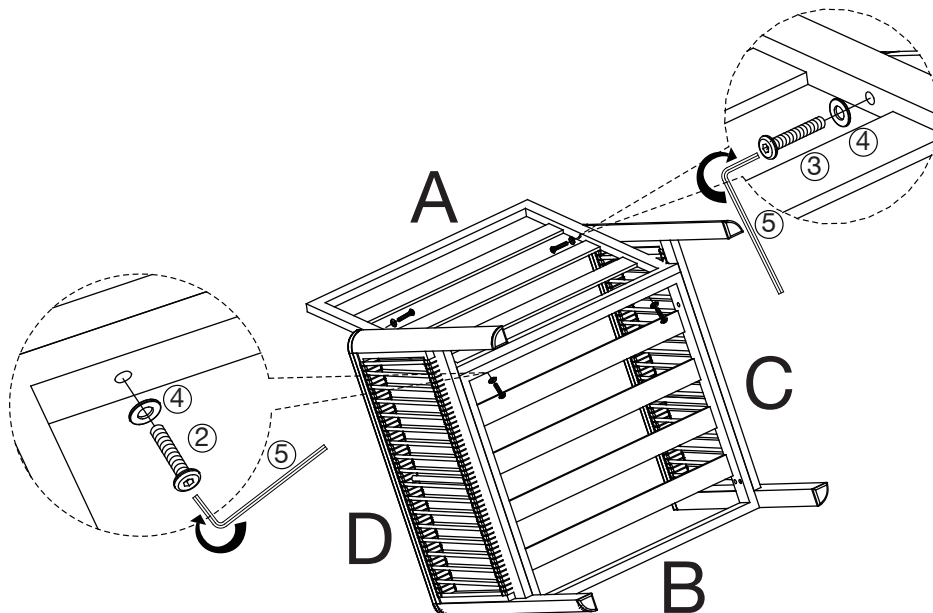

Step 3

Put the Parts (E) and (F) to the chair as shown.

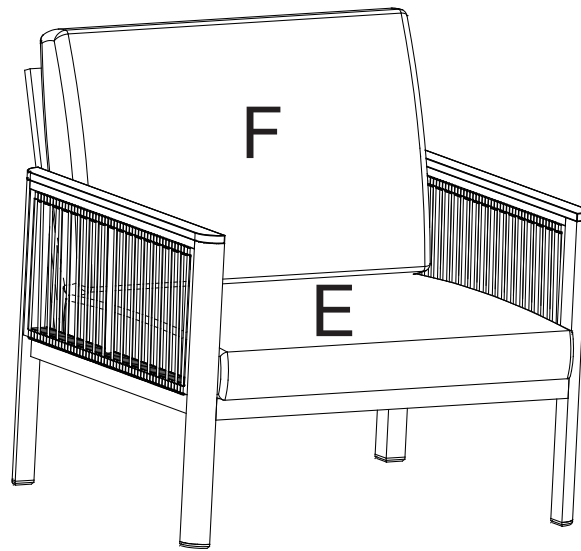

VOILA!
Now enjoy.

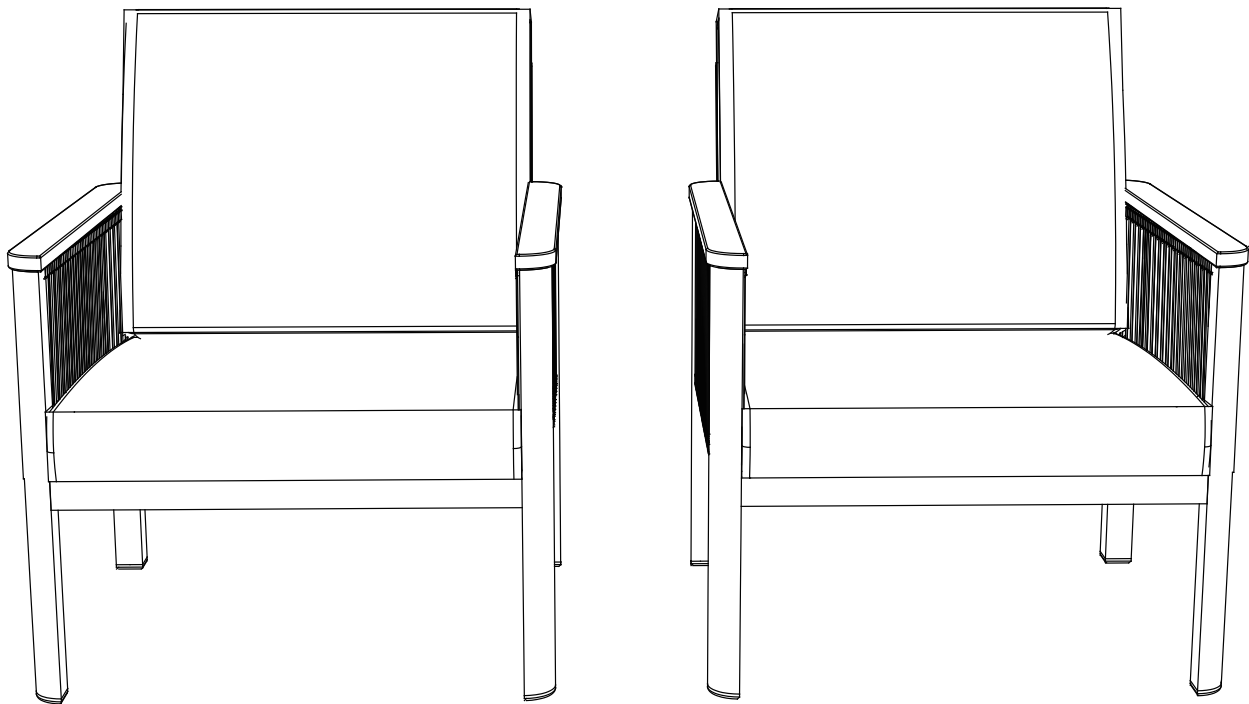

Warning

DO NOT stand on the chair as this may damage the product and cause serious bodily injury.

Something not right?

We are always here to help.

We make mistakes like every human does.

Though we always strive to provide the best possible products at competitive prices and the best service in the industry, it's not possible to completely eliminate mistakes. If you experience any dissatisfaction, feel free to contact us immediately. Our in-house customer care team will respond ASAP.



customerservice@luxenhome.com
Get response within 24 hrs



909.548.6688
Mon-Fri 9am-5pm PST/PDT



www.luxenhome.com/help
Submit a ticket on our website

Things to do to expediate the process

- Have your order# ready
- Take photos/videos to help us better identify the issues
- DO NOT throw away the packaging

Happy with our product?

Leave us a review

It really help us as a small business

- Find the product you purchased on our website (tip: search by SKU) and leave us a review.
- Alternatively, you can always return to the marketplace where you purchased it and leave a review there.

Share with others

Our customers look for REAL stuff



- Follow us on IG @ luxen.home
- Share your #liveluxen moments



Please save this manual
for future reference.

Outdoor Sofa and Table

SKU WHOF2316-ST

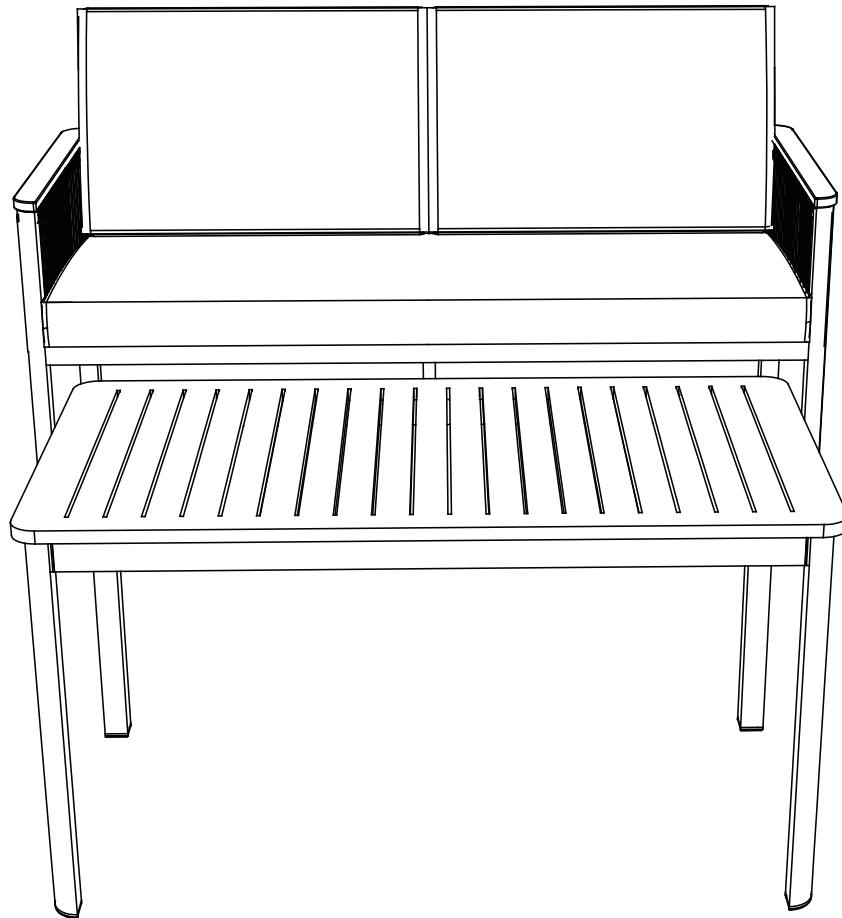

ASSEMBLY INSTRUCTIONS



60 min. assembly

2 person

*The estimated assembly time may vary depending on the individual.

Hey, there

Now is assembly time!

Deeeeeeep breathe.... and again....
Tools ready,
Easy peasy!

Estimated



60 min. assembly
2 person

Tools Required

- Allen Wrench (included)

important: Cautious when you use power tools

Need Help?

Call us at +1 909 548 6688
Email customerservice@luxenhome.com
Submit a ticket on www.luxenhome.com/help

Thank you for purchasing this LuxenHome product. This product has been manufactured with the highest standards of safety and quality.

PLEASE READ ALL INSTRUCTIONS CAREFULLY BEFORE ASSEMBLY.

Unpack all parts from the packaging inside the carton to ensure there are no missing or damaged parts. Lay out all the parts on a clean, flat, and soft surface to prevent scratches. Refer to the steps provided as assembling guide.

Do not attempt to assemble or use the product if any parts are missing or damaged.

REMINDERS

SAFE USAGE IS KEY

Your well-being is our top priority when you use our product. Please prioritize your safety by diligently following the assembly guidelines and inspecting the product carefully both when it arrives and before each use.

Please be aware that LuxenHome and Winsome House, Inc. cannot be held liable for any injuries or fatalities that occur due to not adhering to the provided instructions or misuse of the product.

DO NOT MODIFY

Our products undergo rigorous testing to ensure they meet established safety standards before being released for sale. Altering the product in any way can lead to serious safety concerns, for which LuxenHome cannot assume responsibility.

What's in the box

Parts

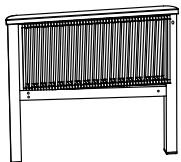

A X 1
Right armrest

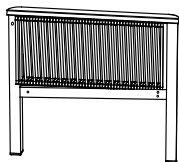

B X 1
Left armrest

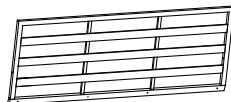

C X 1
Back panel



D X 1
Seat panel

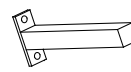

E X 1
Middle leg

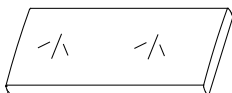

F X 1
Seat cushion

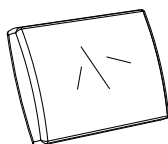

G X 2
Back cushion

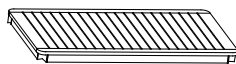

H X 1
Table top



I X 4
Table leg

Hardware & Accessory

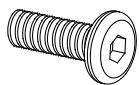

1 X 3
M6 x 20mm

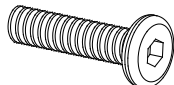

2 X 7
M6 x 30mm

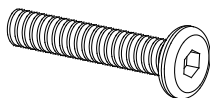

3 X 5
M6 x 35mm

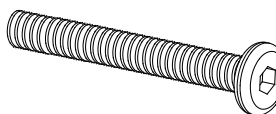

4 X 3
M6 x 55mm

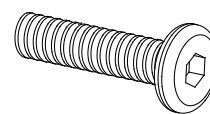

5 X 9
M8 x 30mm



6 X 15
Φ 6mm



7 X 9
Φ 8mm



8 X 1
4mm



9 X 1
5mm

Assembly

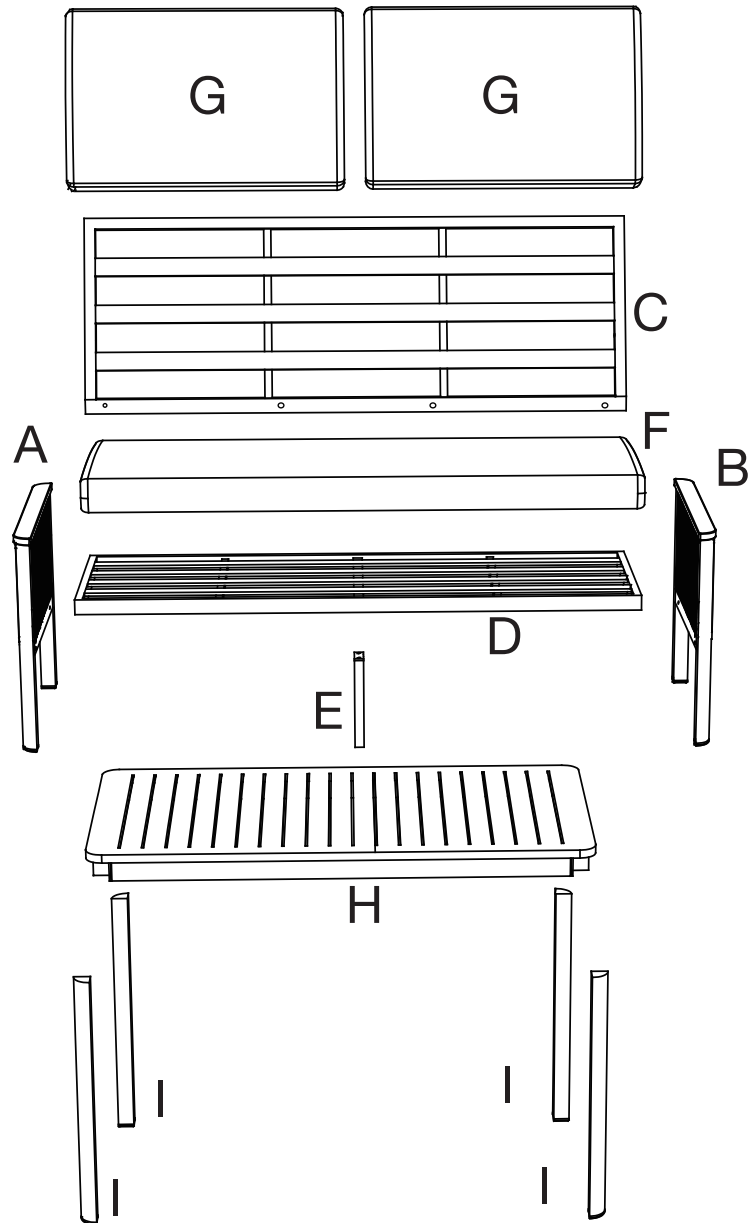

Step 1-1

Connect the Parts (A) and (B) to the Part (D) as shown, and also connect the Part (E) to the Part (D) as shown.

① X 2	② X 6	⑥ X 8	⑧ X 1
M6 x 20mm	M6 x 30mm	Ø6mm	4mm

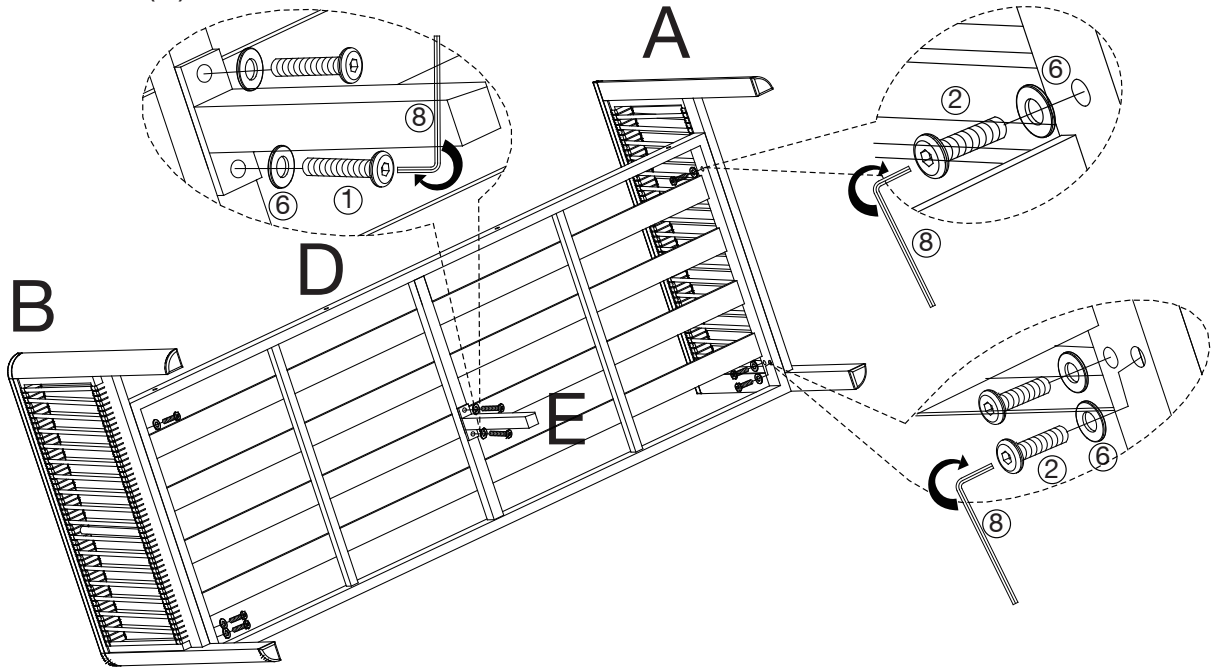

Step 1-2

Connect the Part (C) to the Parts (A) and (B) and (D) as shown.

③ X 4	④ X 2	⑥ X 6	⑧ X 1
M6 x 35mm	M6 x 55mm	Ø6mm	4mm

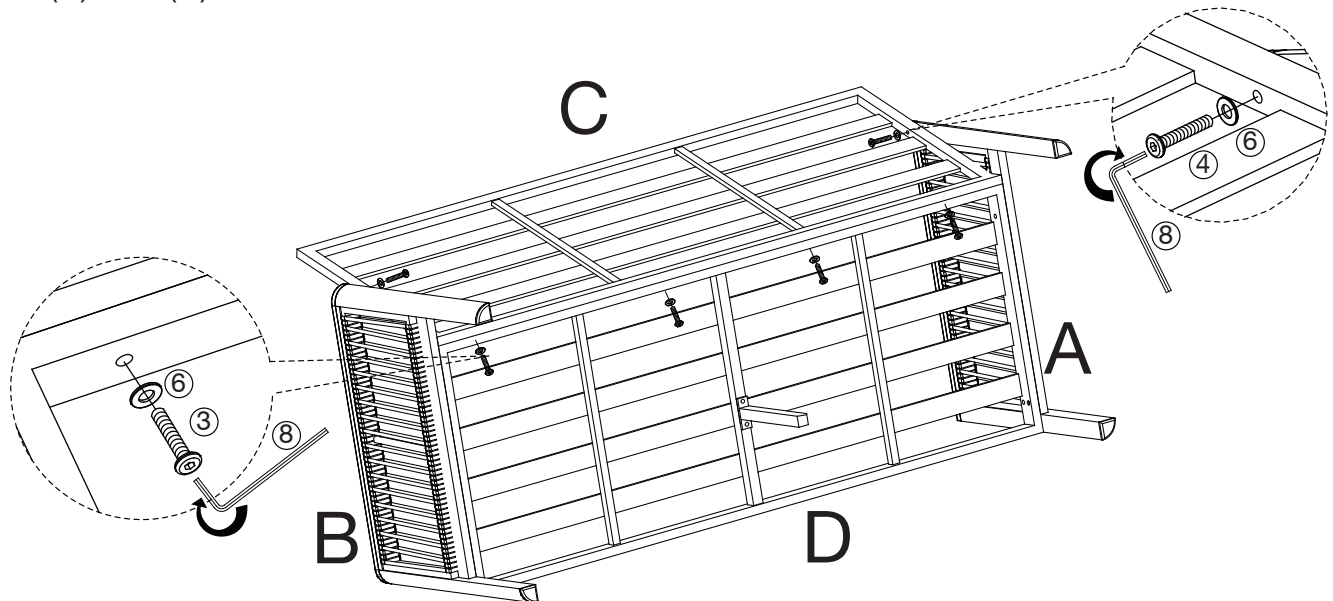

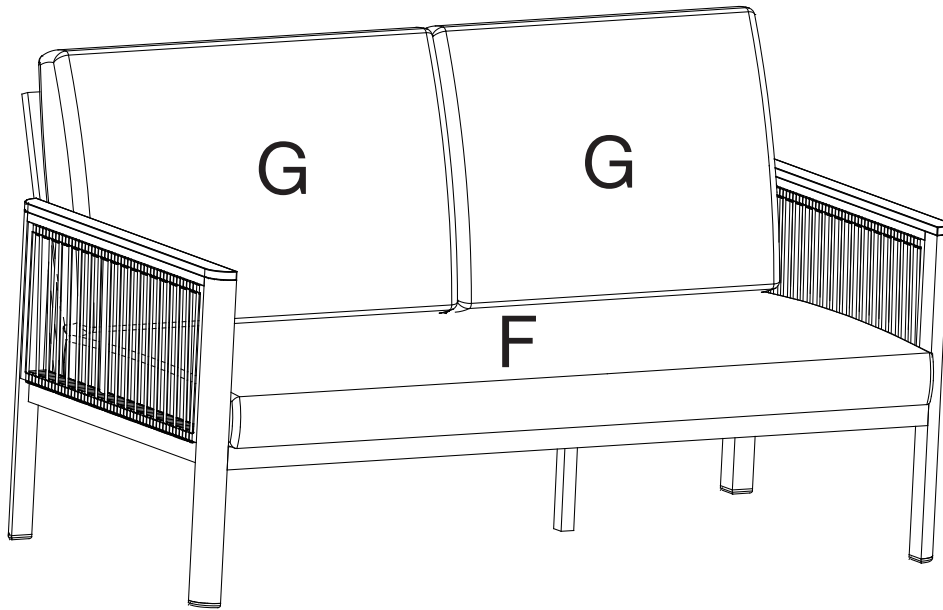

Step 1-3

Put the Parts (G) and (F) to the sofa as shown.



Step 2-1

Connect the Parts (I) to the Part (H) as shown.

⑤ X 8	⑦ X 8	⑨ X 1
 M8 x 30mm	 Ø8mm	 5mm

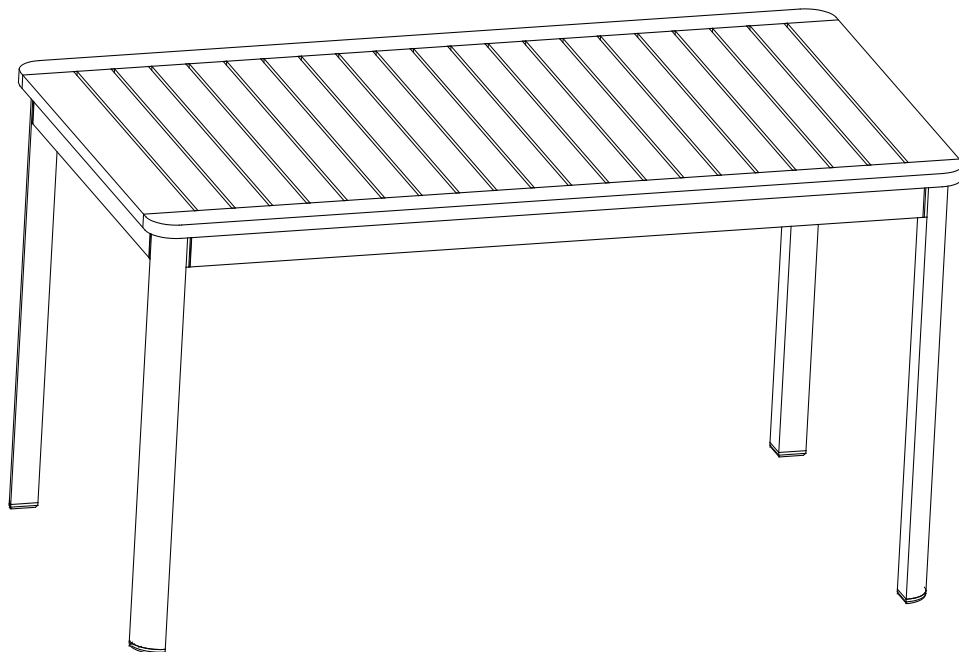
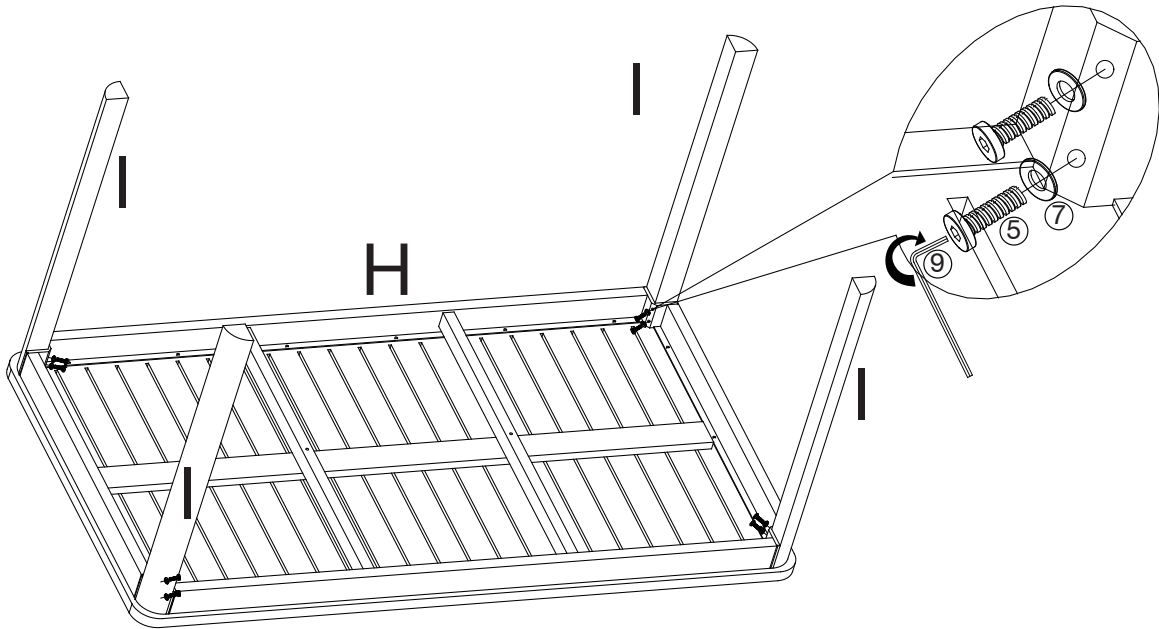

VOILA!
Now enjoy.

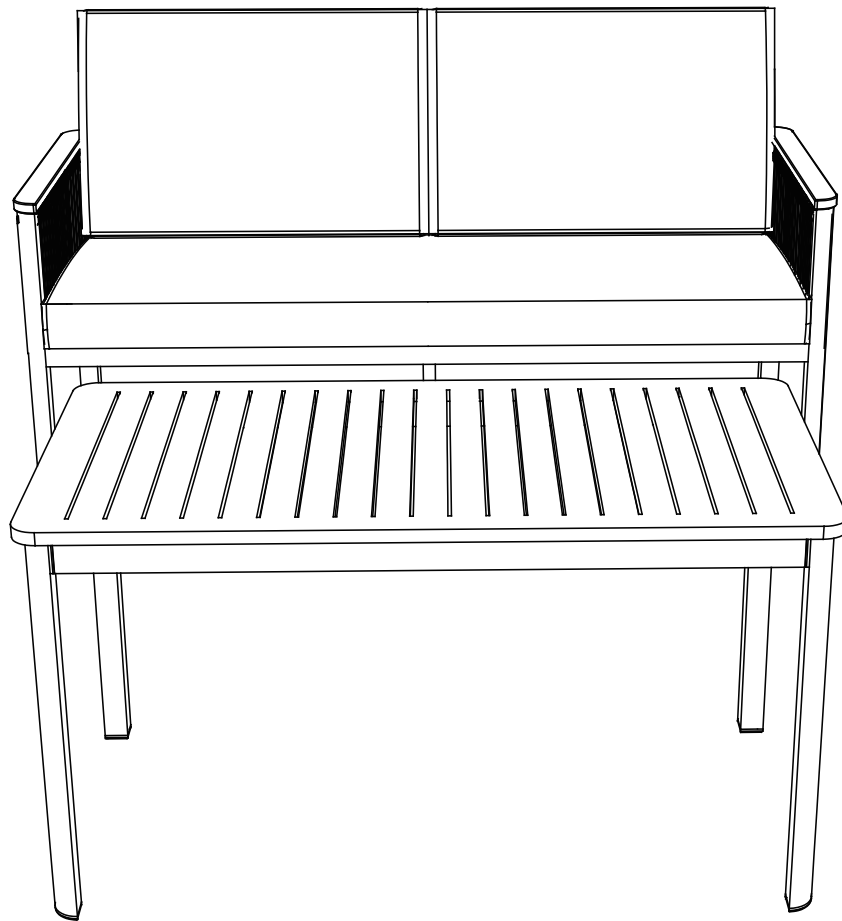

Warning

DO NOT stand or jump on the loveseat or table as this may damage the product and cause serious bodily injury.

Something not right?

We are always here to help.

We make mistakes like every human does.

Though we always strive to provide the best possible products at competitive prices and the best service in the industry, it's not possible to completely eliminate mistakes. If you experience any dissatisfaction, feel free to contact us immediately. Our in-house customer care team will respond ASAP.



customerservice@luxenhome.com
Get response within 24 hrs



909.548.6688
Mon-Fri 9am-5pm PST/PDT



www.luxenhome.com/help
Submit a ticket on our website

Things to do to expediate the process

- Have your order# ready
- Take photos/videos to help us better identify the issues
- DO NOT throw away the packaging

Happy with our product?

Leave us a review

It really help us as a small business

- Find the product you purchased on our website (tip: search by SKU) and leave us a review.
- Alternatively, you can always return to the marketplace where you purchased it and leave a review there.

Share with others

Our customers look for REAL stuff



- Follow us on IG @ luxen.home
- Share your #liveluxen moments



Please save this manual
for future reference.