



**INSTRUCTIONS D'ASSEMBLAGE
ASSEMBLY INSTRUCTIONS**

**TABLE D'APPOINT -
47"L / CONSOLE D'ENTREE ESPRESSO**

**ACCENT TABLE -
47"L / ESPRESSO HALL CONSOLE**



**POUR DE L'ASSISTANCE OU POUR COMMANDER
DES PIÈCES CONTACTEZ NOTRE DÉPARTEMENT
DE SERVICE À LA CLIENTÈLE.**

**FOR ASSISTANCE OR TO ORDER PARTS
CONTACT OUR CUSTOMER SERVICE DEPARTMENT**

LISTE DES PIÈCES
PARTS LIST

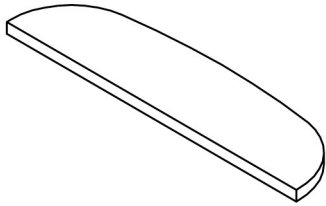
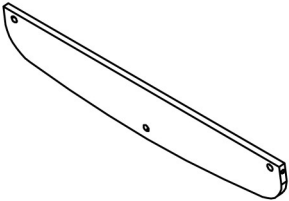
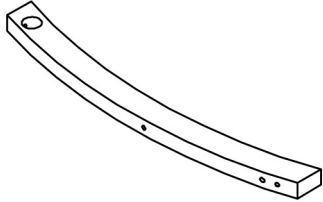
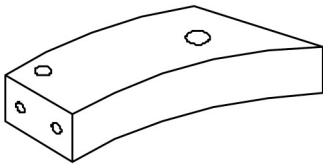
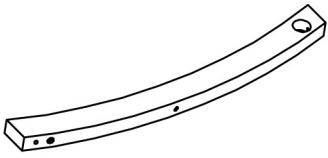
PIÈCE / PART #	IMAGE	DESCRIPTION	QTY / QTÉ
1		TABLE TOP SURFACE DE TABLE	1
2		SHELF ÉTAGÈRE	1
3		SUPPORT LEG PATTE DE SOUTIEN	1
4		BRACE ATTACHE	1
5		FRONT FACING LEFT LEG PATTE AVANT GAUCHE	1

LISTE DES PIÈCES
PARTS LIST

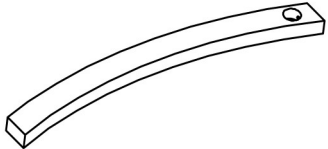
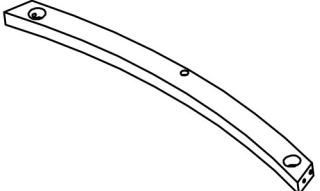
PIÈCE / PART #	IMAGE	DESCRIPTION	QTY / QTÉ
6		FRONT FACING RIGHT LEG PATTE AVANT DROITE	1
7		CROSSBAR BARRE TRANSVERSALE	1

LISTE DES PIÈCES DE MONTAGE
HARDWARE LIST

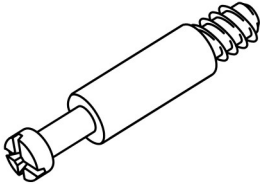
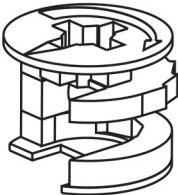
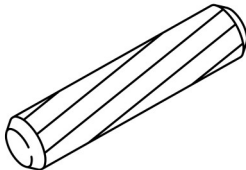
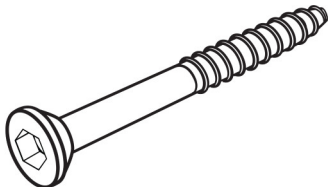
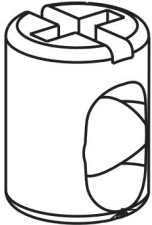
PIÈCE / PART #	IMAGE	DESCRIPTION	QTY / QTÉ
A		CAM LOCK SCREW - 1 1/8" VIS CAM LOCK - 1 1/8"	4
B		CAM LOCK CONNECTOR - Ø5/8" ÉCROU CAM LOCK - Ø5/8"	4
C		WOOD DOWEL - Ø3/8" X 1" GOUJON DE BOIS - Ø3/8" X 1"	7
D		ASSEMBLING SCREW - Ø1/4" X 2 5/8" VIS D'ASSEMBLAGE - Ø1/4" X 2 5/8"	1
E		BARREL NUT - Ø3/8" X 5/8" ÉCROU DE CANON - Ø3/8" X 5/8"	1

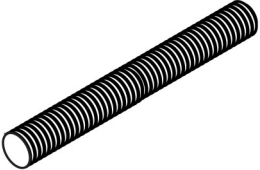
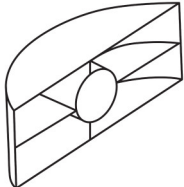
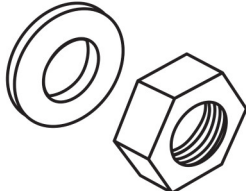
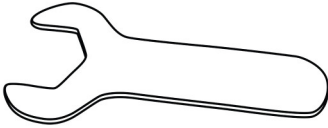
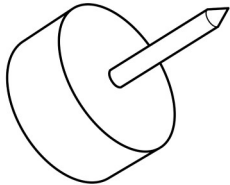

LISTE DES PIÈCES DE MONTAGE
HARDWARE LIST

PIÈCE / PART #	IMAGE	DESCRIPTION	QTY / QTÉ
F		THREADED ROD - Ø3/8" X 2 3/4" TIGE FILETÉE - Ø3/8" X 2 3/4"	5
G		NUT ÉCROU	5
H		NUT SET ENSEMBLE D'ÉCROU	5
I		SPANNER CLÉ ANGLAISE	1
J		FLOOR PROTECTOR - Ø5/8" PROTECTEUR DE PLANCHER - Ø5/8"	3

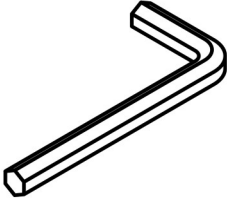
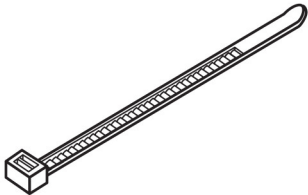
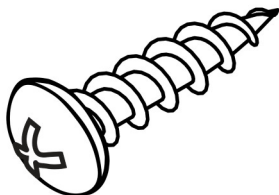
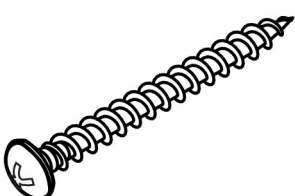
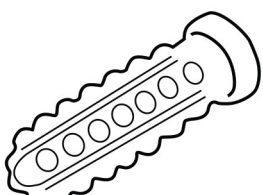
LISTE DES PIÈCES DE MONTAGE
HARDWARE LIST

PIÈCE / PART #	IMAGE	DESCRIPTION	QTY / QTÉ
K		<p style="text-align: center;">HEX KEY CLÉ HEXAGONALE</p>	1
L		<p style="text-align: center;">ZIP TIE - 7 3/4" X 1/8" ATTACHE AUTOBLOQUANTE - 7 3/4" X 1/8"</p>	1
M		<p style="text-align: center;">ASSEMBLING SCREW - Ø1/8" X 1" VIS D'ASSEMBLAGE - Ø1/8" X 1"</p>	1
N		<p style="text-align: center;">ASSEMBLING SCREW - Ø1/4" X 1 1/2" VIS D'ASSEMBLAGE - Ø1/4" X 1 1/2"</p>	1
O		<p style="text-align: center;">ANCHOR - Ø3/8" X 1 1/2" ANCRE - Ø3/8" X 1 1/2"</p>	1

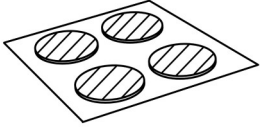
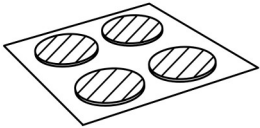
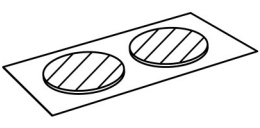
LISTE DES PIÈCES DE MONTAGE
HARDWARE LIST

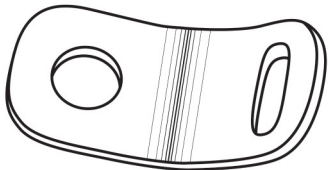
PIÈCE / PART #	IMAGE	DESCRIPTION	QTY / QTÉ
P		FINISHING STICKER - Ø1 3/4" COLLANT DE FINITION - Ø1 3/4"	5
Q		FINISHING STICKER - Ø3/4" COLLANT DE FINITION - Ø3/4"	5
R		FINISHING STICKER - Ø1/2" COLLANT DE FINITION - Ø1/2"	1
S		GLUE COLLE	1
T		METAL BRACKET - 1/2" X 1/2" SUPPORT DE MÉTAL - 1/2" X 1/2"	2

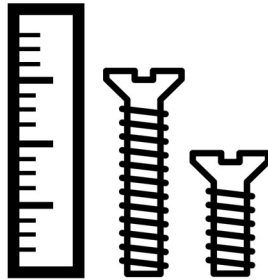

**OUTIL DE VÉRIFICATION DE DIMENSIONS DES PIÈCES
HARDWARE DIMENSIONS VERIFICATION TOOL**

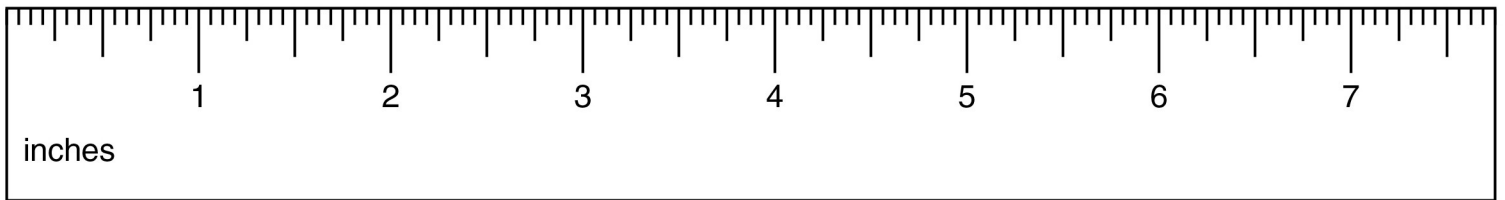

ÉTAPE / STEP 1

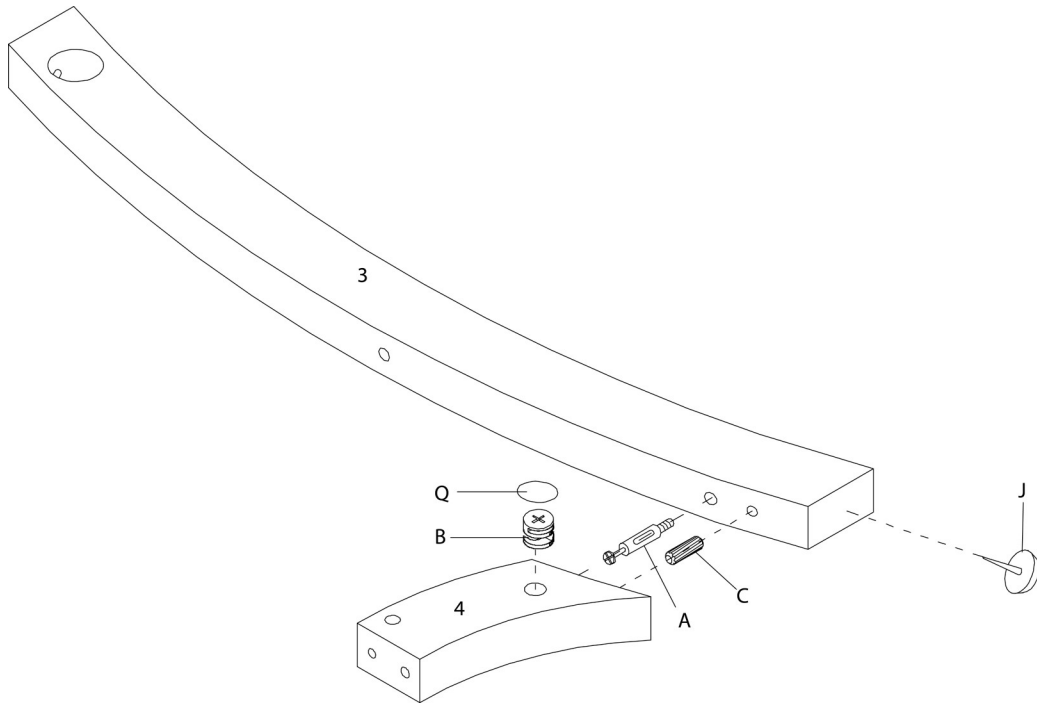

ÉTAPE / STEP 2

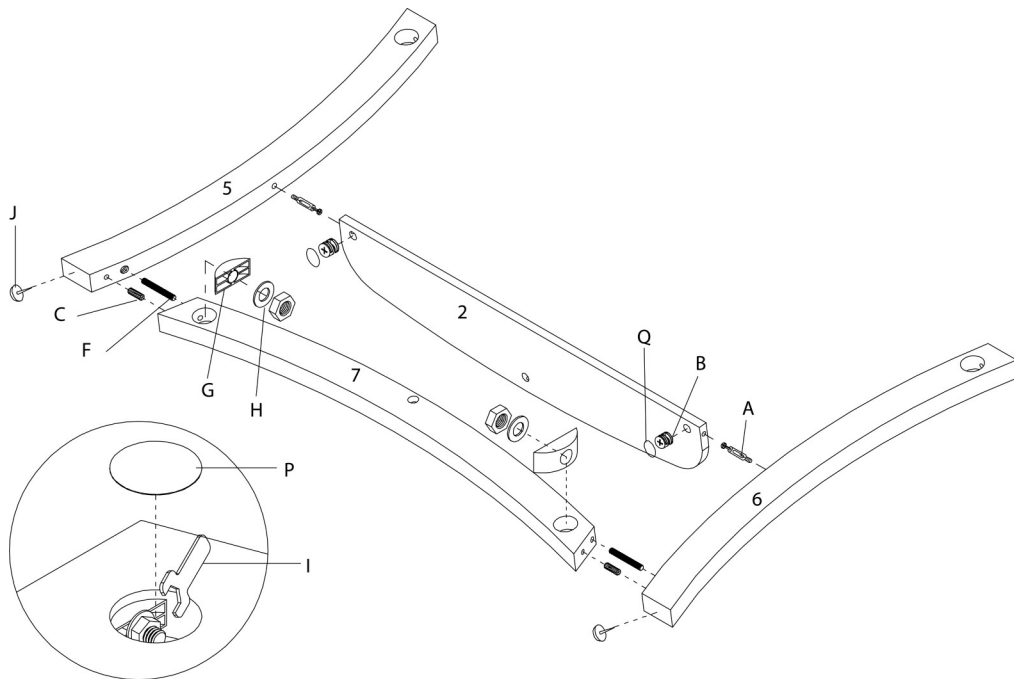

ÉTAPE / STEP 3

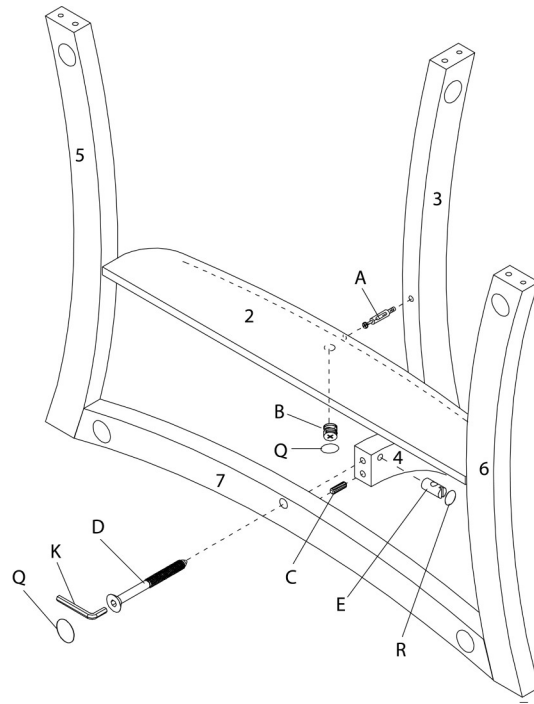

ÉTAPE / STEP 4

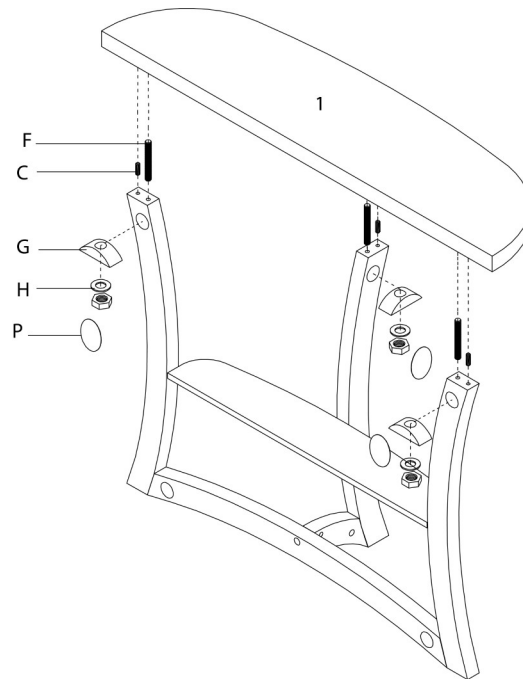

ÉTAPE / STEP 5

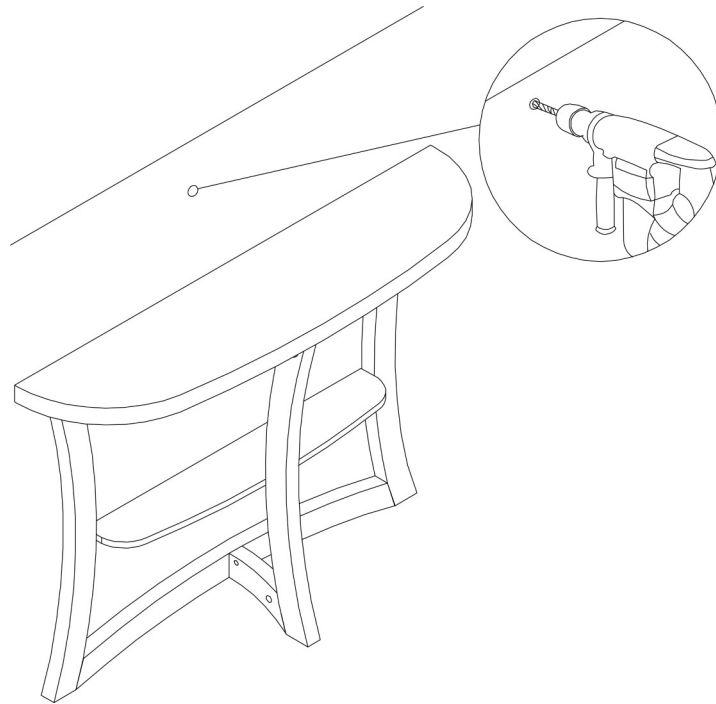

ÉTAPE / STEP 6

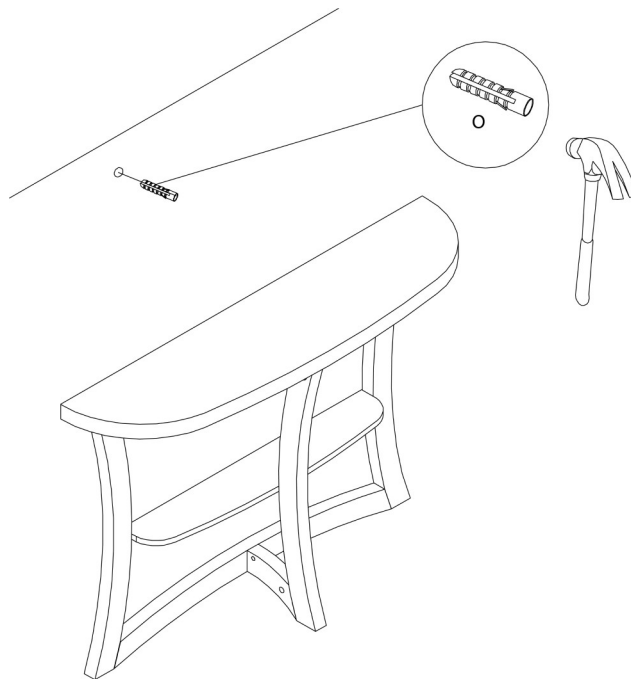

ÉTAPE / STEP 7

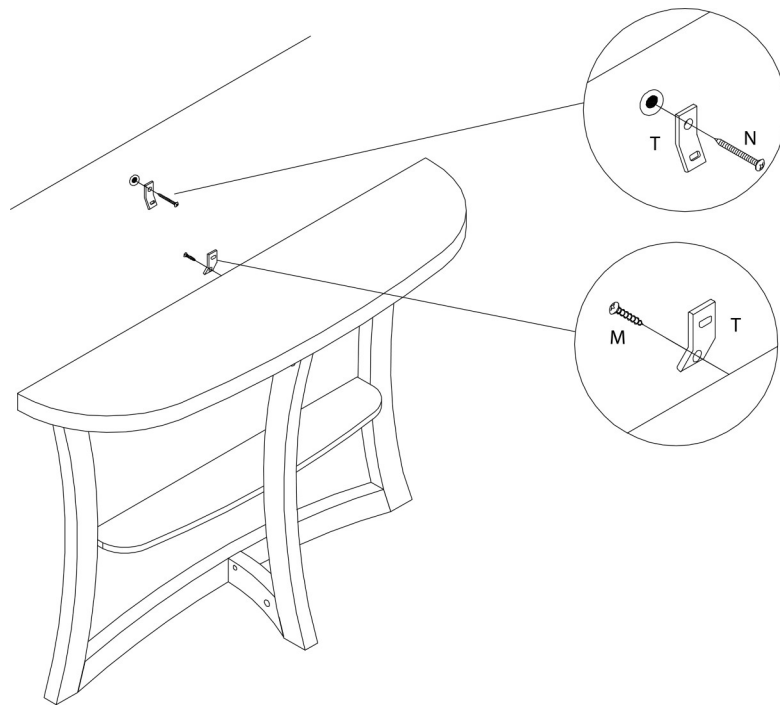

ÉTAPE / STEP 8

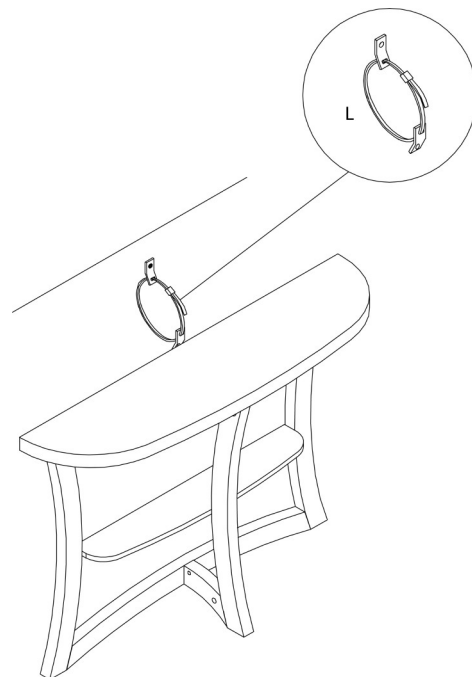

ÉTAPE / STEP 9

