

EN:

CAUTION:

- * Before using the bar stool, ensure that all screws are fully tightened.
- * Retighten all screws every 6 months or as needed.

To remove odor, air the chair outdoors in shade for 1-2 days.

Periodically retighten all screws. Do not use an electric screwdriver.

ES:

PRECAUCIÓN:

- * Antes de usar el taburete, asegúrese de que todos los tornillos estén bien apretados.
- * Vuelva a apretar todos los tornillos cada 6 meses o cuando sea necesario.

Para eliminar el olor, aeree la silla al aire libre, a la sombra, durante 1-2 días.

Vuelva a apretar periódicamente todos los tornillos. No utilice un atornillador eléctrico.

FR :

ATTENTION :

- * Avant d'utiliser le tabouret de bar, assurez-vous que toutes les vis sont bien serrées.
- * Resserrez toutes les vis tous les 6 mois ou selon les besoins.

Pour éliminer les odeurs, aérez la chaise à l'extérieur à l'ombre pendant 1 à 2 jours.

Resserrez périodiquement toutes les vis. N'utilisez pas de tournevis électrique.

Installation & Assembly

A X1	B X1	C X1	D X1	E X1	F X1
1 X4	2 X6	3 X2	4 X8	5 X8	6 X1
M6 x 60 mm	M6 x 35 mm	M6 x 40 mm			

Safety Information / Información de seguridad / Informations Relatives à la Sécurité





EN:  : Partially tighten the screws.

 : Fully tighten the screws.





ES:  : Apriete parcialmente los tornillos.

 : Apriete completamente los tornillos.

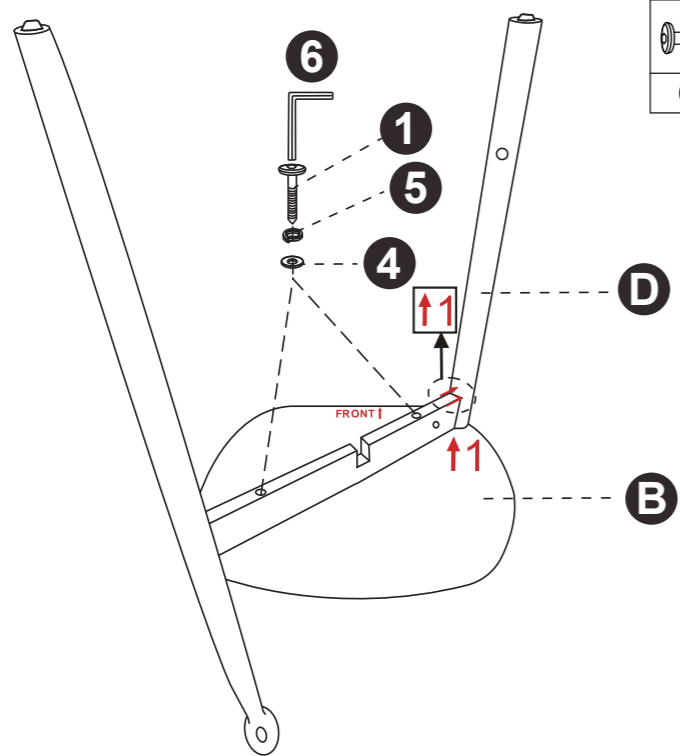
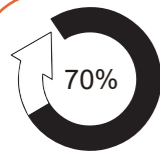
FR:  : Serrez d'abord les vis partiellement.

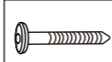



 : Serrez les vis complètement.

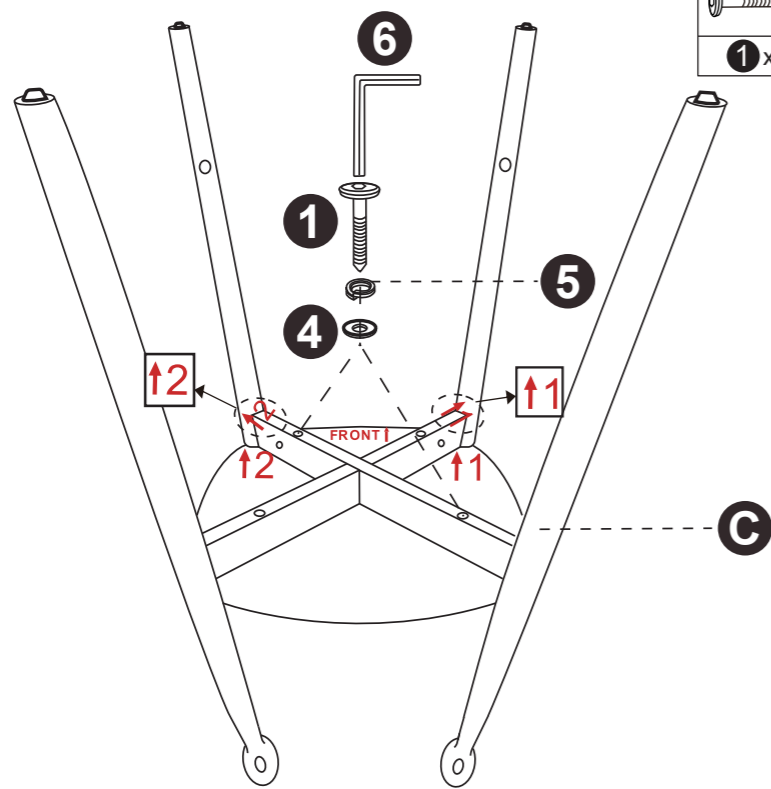
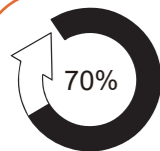

			
1 x2	4 x2	5 x2	6 x1

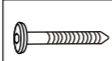



1

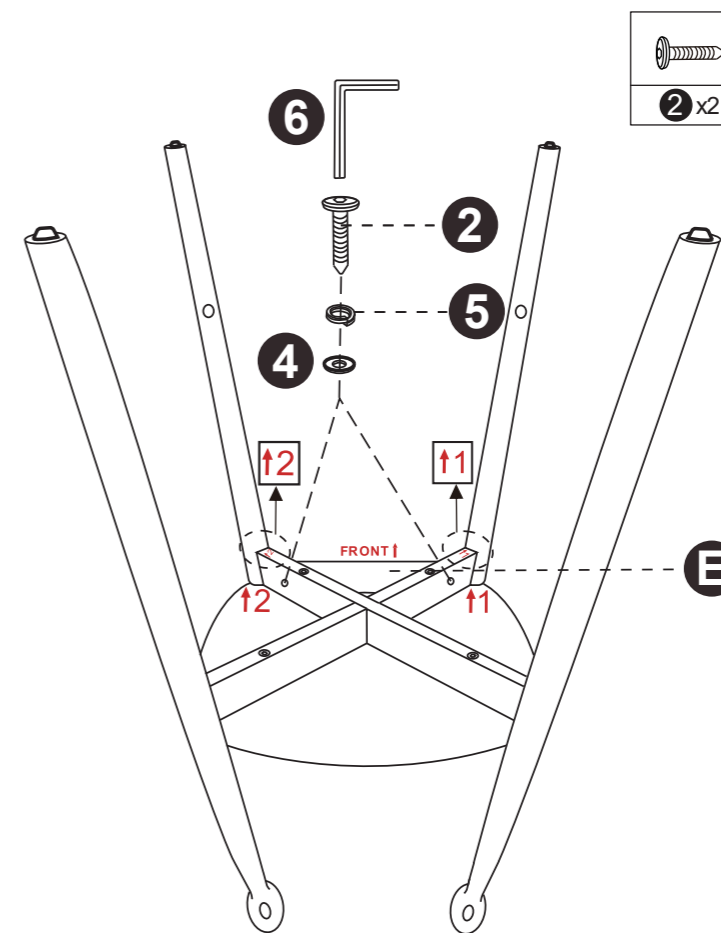
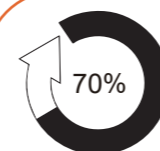

			
1 x2	4 x2	5 x2	6 x1



2

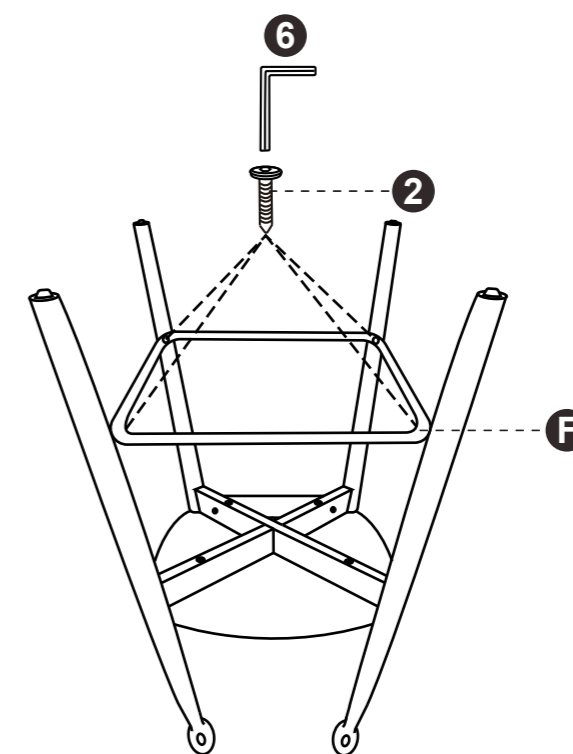
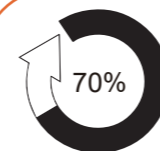

			
2 x2	4 x2	5 x2	6 x1

3



	
2 x4	6 x1

4

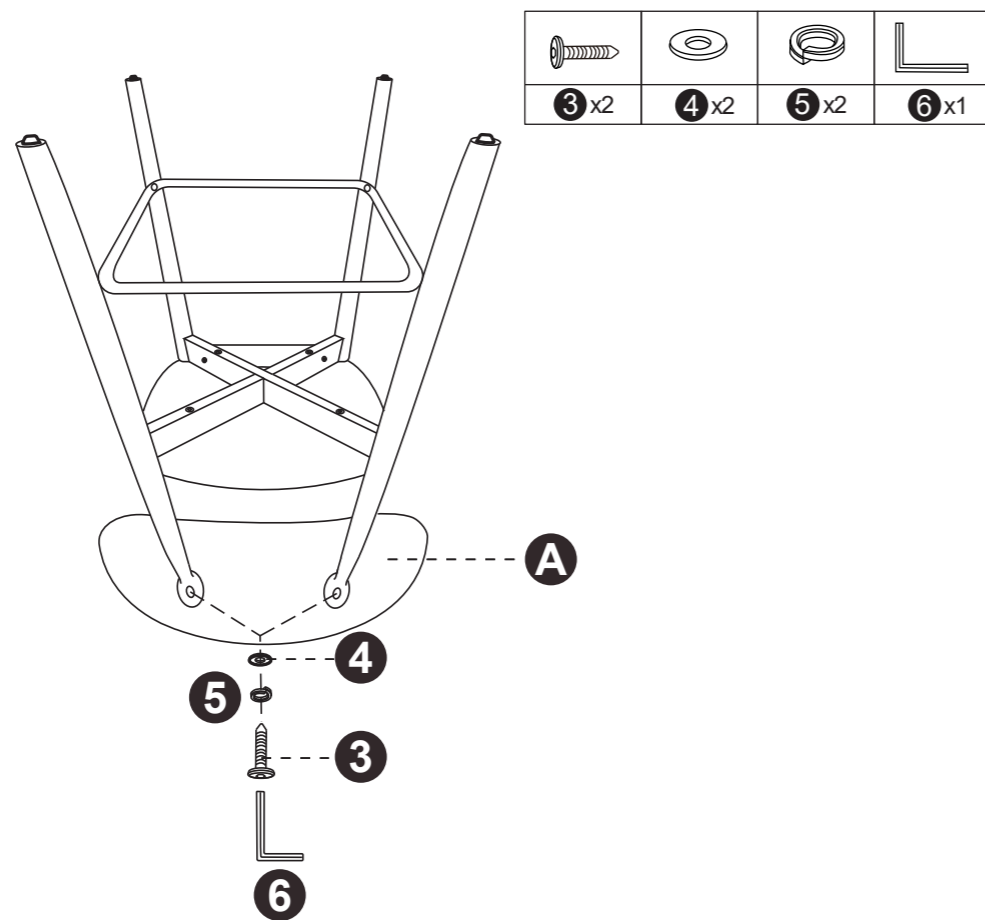

5

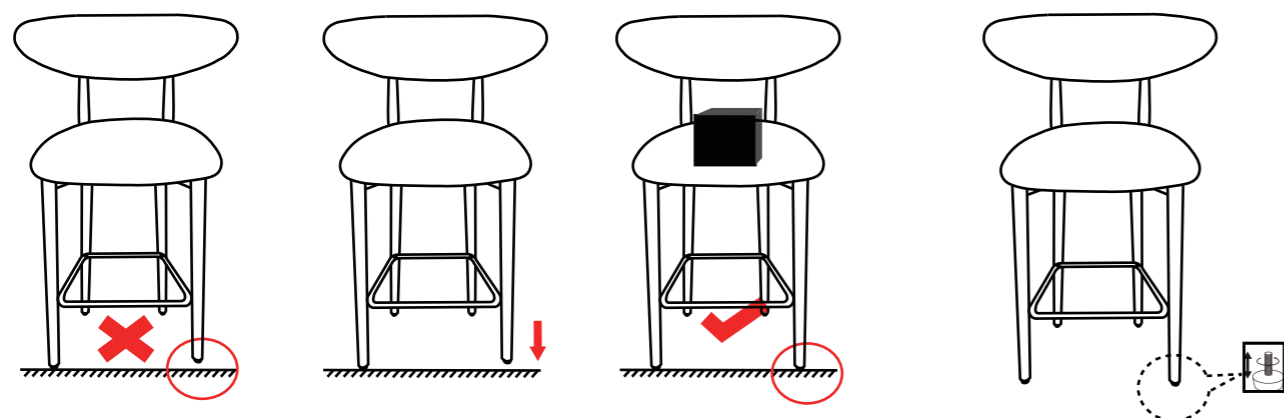

EN: Place an appropriate load on the stool and adjust the feet until it is level and stable.

ES: Coloque una carga adecuada en el taburete y ajuste las patas hasta que el taburete esté nivelado y estable.

6 FR: Placez une charge appropriée sur le tabouret et ajustez les pieds jusqu'à ce qu'il soit stable et de niveau.

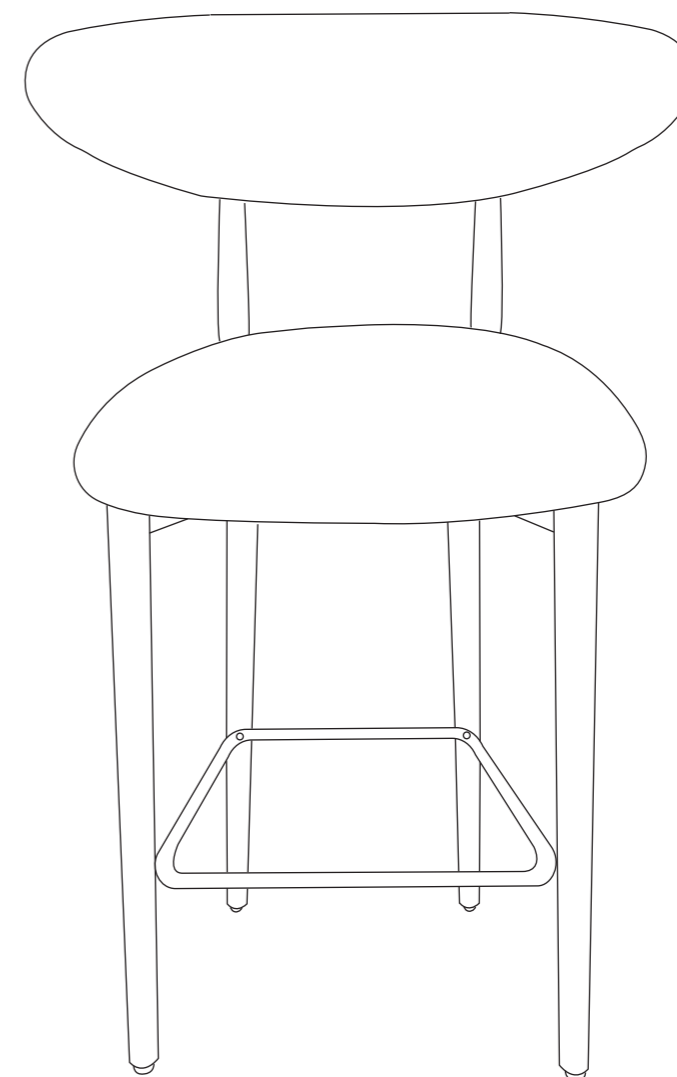

EN: After all parts are in place and the stool is leveled, tighten all screws.

ES: Después de que todas las piezas estén colocadas y el taburete esté nivelado, apriete todos los tornillos.

7 FR: Une fois toutes les pièces en place et le tabouret mis à niveau, serrez toutes les vis.