







CONSOLE TABLE ASSEMBLY INSTRUCTION

PARTS LIST Before you begin , please layout all parts and ensure you have the correct count .

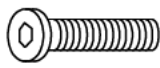
#	DESCRIPTION	QTY	ILLUSTRATION
A	TABLE TOP	1	
B	TABLE BASE	1	
C	ALLEN KEY (4MM)	1	
D	ALLEN BOLT (M8x30)	3	
E	LOCK WASHER (M8)	3	
F	FLAT WASHER (M8)	3	
G	TIPPING RESTRAINT	2	

ASSEMBLY INSTRUCTIONS

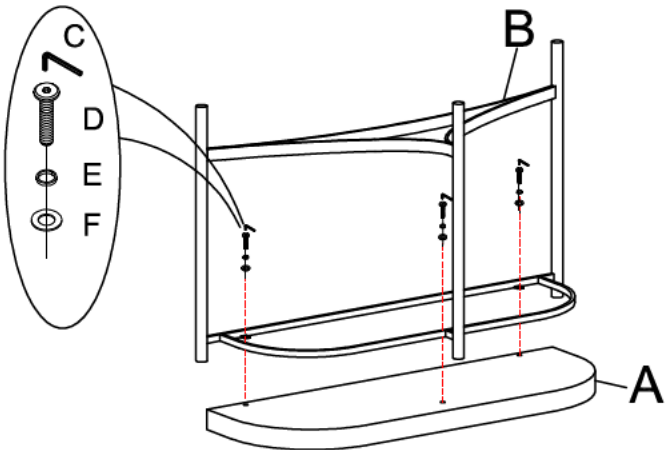
STEP	INSTRUCTIONS	ILLUSTRATION
1	<p>ON A FLAT, LEVEL AREA LAY DOWN A CLEAN BLANKET OR TOWEL. PLACE THE TABLE TOP (A) TOPSIDE DOWN. ATTACH THE TABLE BASE (B) TO THE TOP WITH THREE ALLEN BOLTS (D), LOCK WASHERS (E) AND FLAT WASHERS (F). TIGHTEN WITH PROVIDED ALLEN KEY (C).</p> <p>NOTE! DO NOT OVERTIGHTEN THE BOLTS OR YOU CAN RISK DAMAGING THE TABLE.</p>	

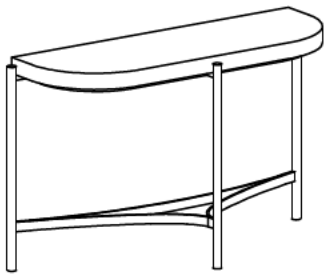

CONSOLE TABLE
ASSEMBLY INSTRUCTION

ASSEMBLY INSTRUCTIONS

STEP

INSTRUCTIONS

ILLUSTRATION

2

WITH THE HELP OF A SECOND PERSON, FLIP THE ASSEMBLED TABLE RIGHT SIDE UP.

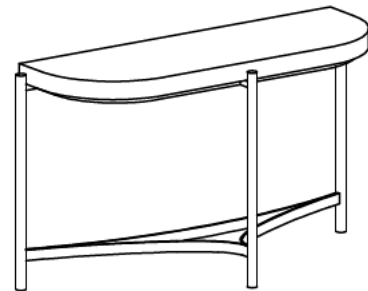

3

NOTE! IF YOU ARE PLANNING ON USING YOUR TABLE ADJACENT TO A WALL, SEE INSTRUCTION BELOW.

PLEASE ATTACH THE CONSOLE TABLE TO A WALL WITH THE PROVIDED TIPPING RESTRAINTS (G).

