













ASSEMBLY INSTRUCTION

IMPORTANT NOTE:

**PLACE ALL PARTS ON A CLEAN AND SMOOTH SURFACE SUCH AS A RUG OR CARPET TO AVOID THE PARTS FROM BEING SCARATCHED.







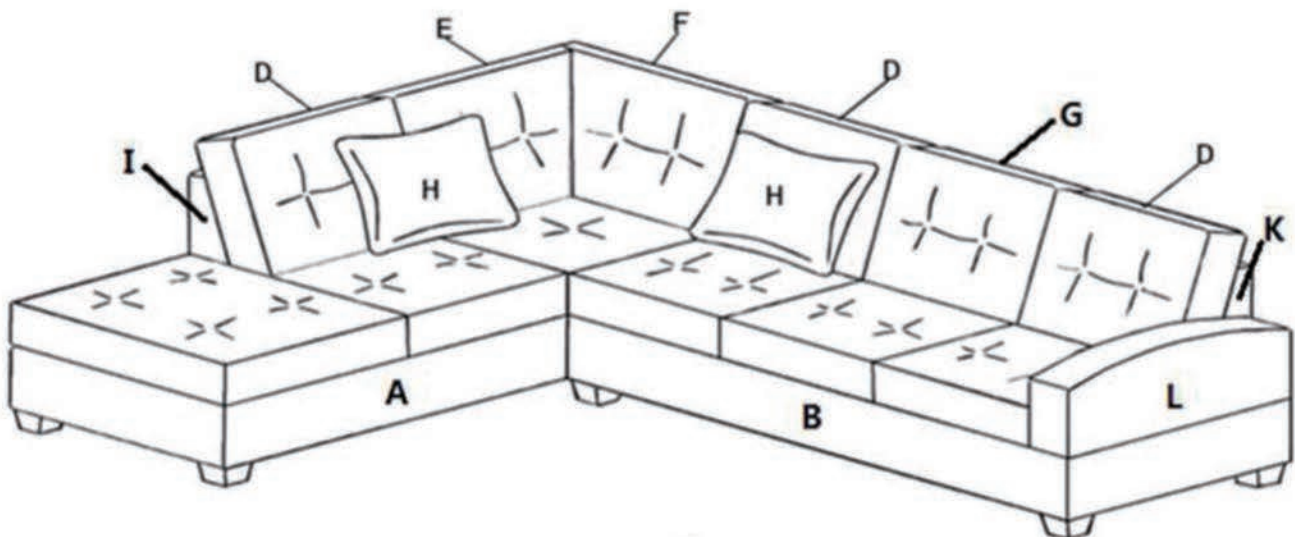

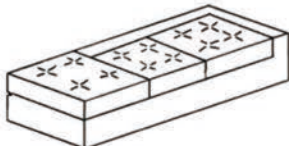
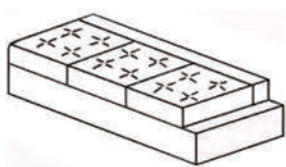
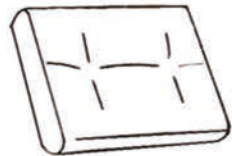

**BEFORE YOU BEGIN, KINDY FOLLOW THE ASSEMBLY INSTRUCTIONS STEP BY STEP.

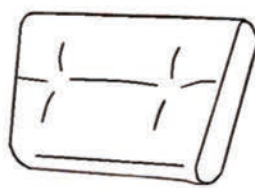
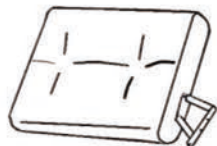
** DO NOT TIGHTEN ALL SCREWS UNIT THE SOFA IS FULLY SET-UP.

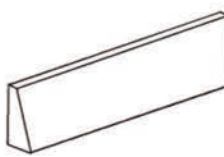
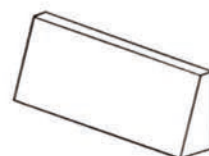
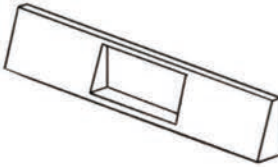
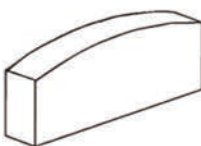
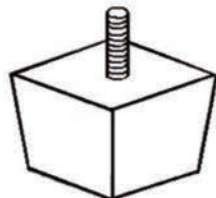
- CH BOX 1 OF 3(CHAISE):** A-  X1 + D-  X1 + G-  X1
+ H-  X2 + I-  X1 + J-  X1
- S1 BOX 2 OF 3(SOFA SEAT):** B-  X1 + D-  X2 + E-  X1
+ F-  X1 + L-  X1 + M-  X8 + HARDWARE
- S2 BOX 3 OF 3 (SOFA BACKREST):** K-  X1

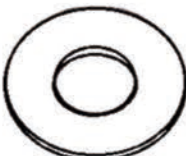

PARTS AND HARDWARE

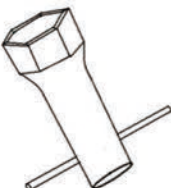
| | | |
|--|--|--|
| A  1PCS | B  1PCS | D  3PCS |
| E  1PCS | F  1PCS | G  1PCS |
| H  2PCS | I  1PCS | J  1PCS |
| K  1PCS | L  1PCS | M  8PCS |
| N  4PCS | O  4PCS | P  1PCS |
| Q  9PCS | R  9PCS | S  9PCS |
| T  1PCS | | |

ASSEMBLY INSTRUCTION

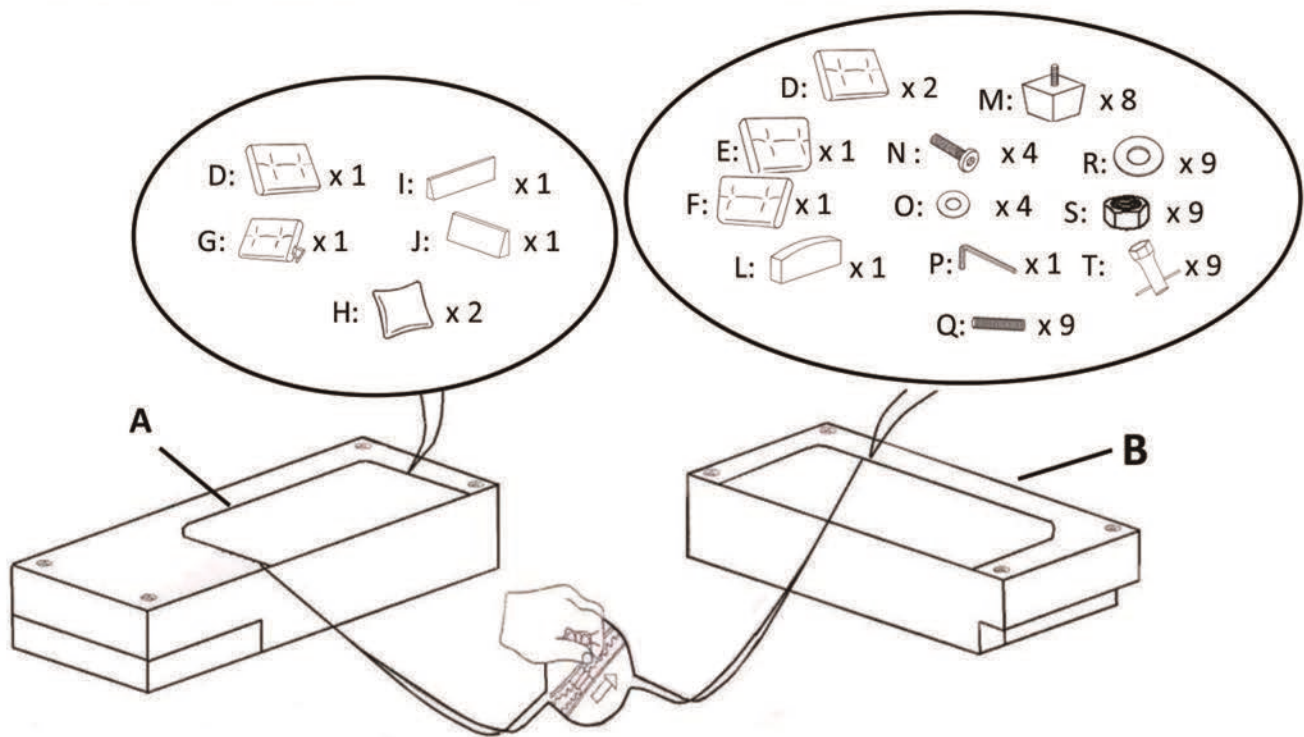

STEP 1:
TAKE OUT ALL THE PARTS FROM INSIDE OF THE SOFA AND CHAISE.

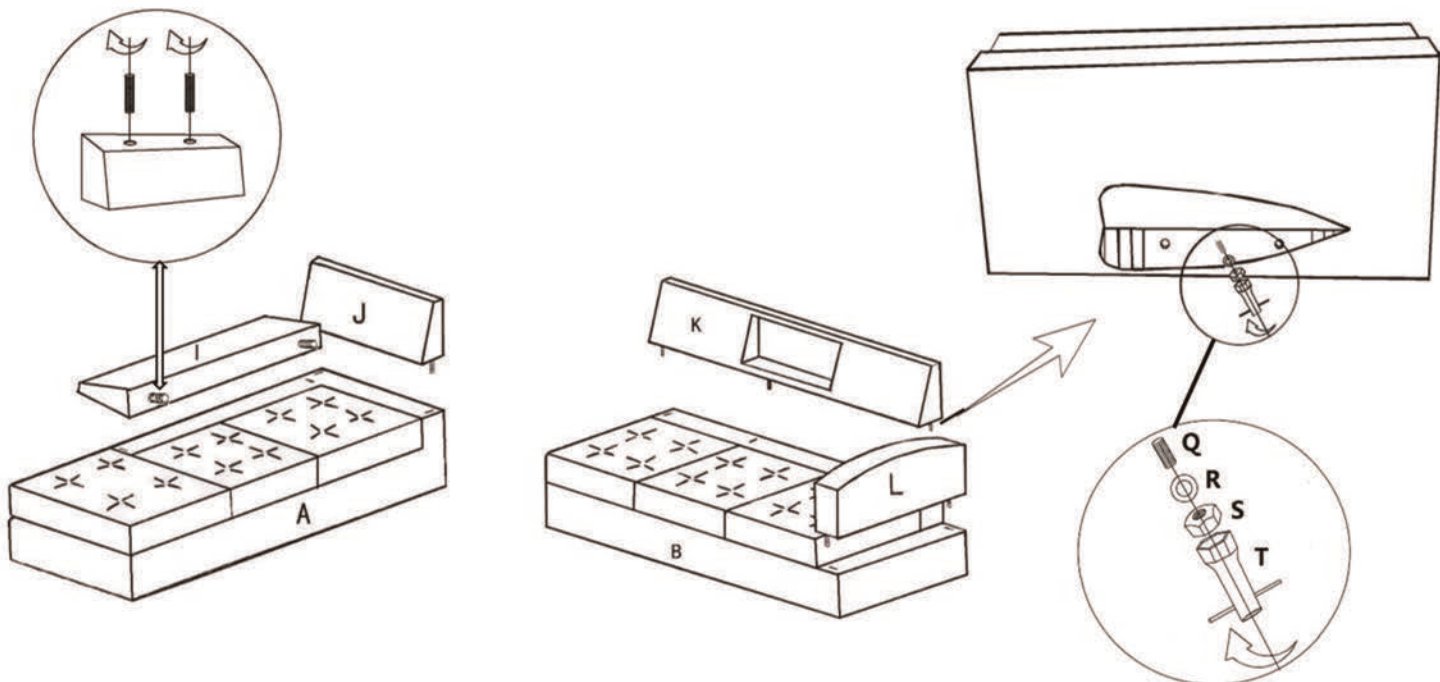

STEP 2:
ATTACH THE BACKREST TO THE CHAISE

STEP 3:
ATTACH THE BACKREST AND ARM TO THE SOFA

ASSEMBLY INSTRUCTION

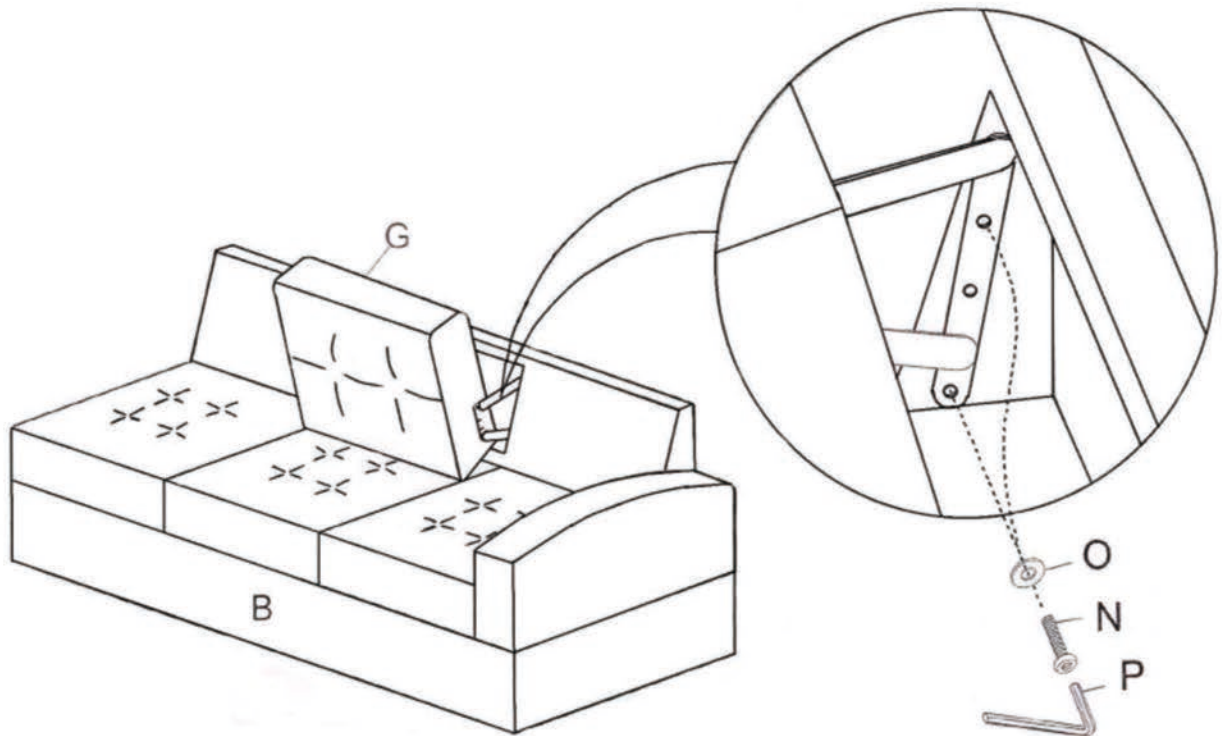

STEP 4:
ATTACH THE DROP DOWN TABLE TO THE BACKREST OF SOFA

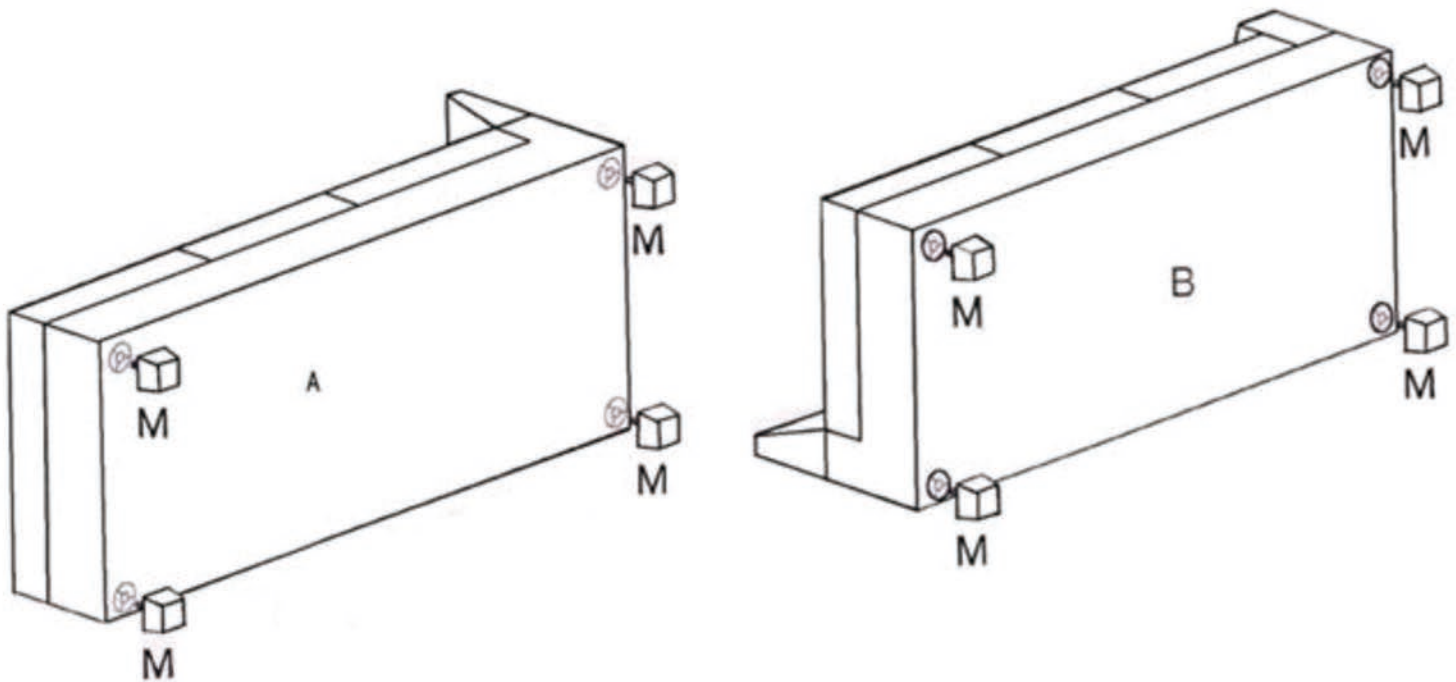

STEP 5:
ATTACH THE LEGS TO SOFA AND CHAISE.

ASSEMBLY INSTRUCTION

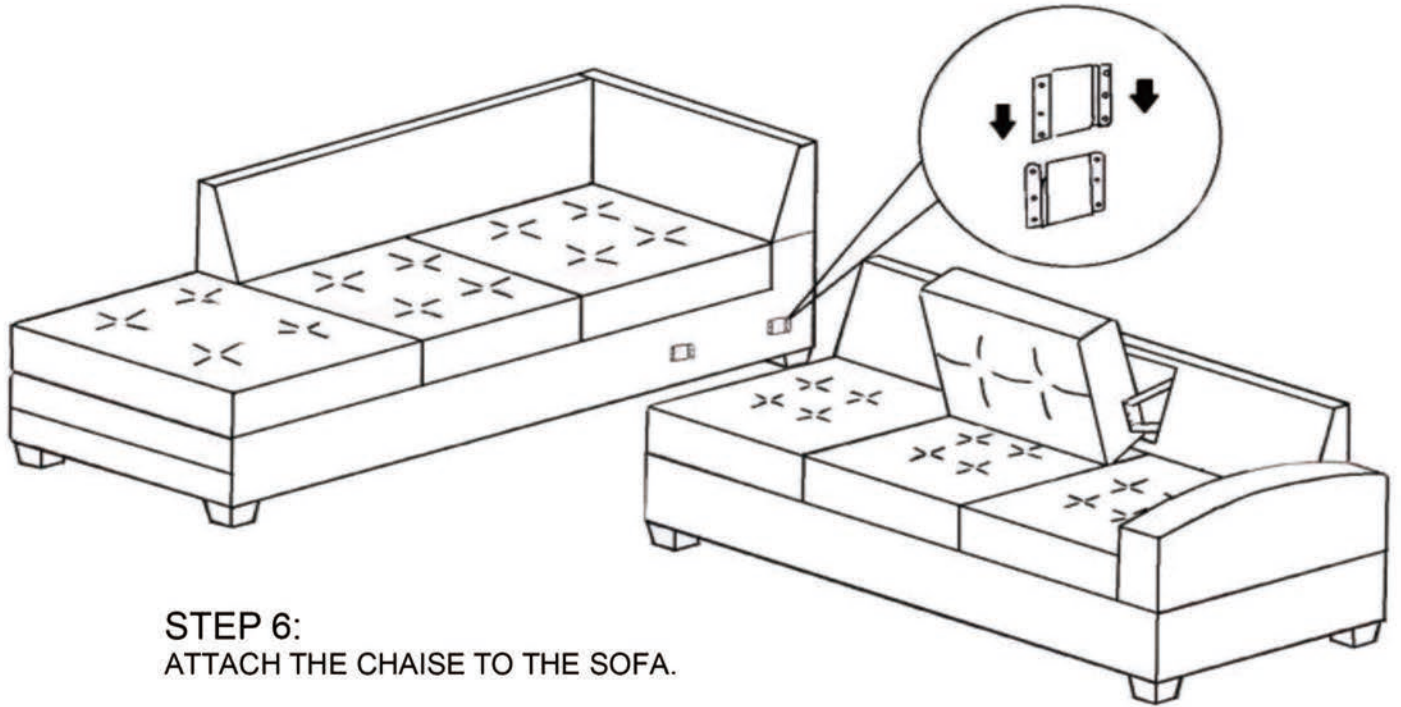

STEP 6:
ATTACH THE CHAISE TO THE SOFA.

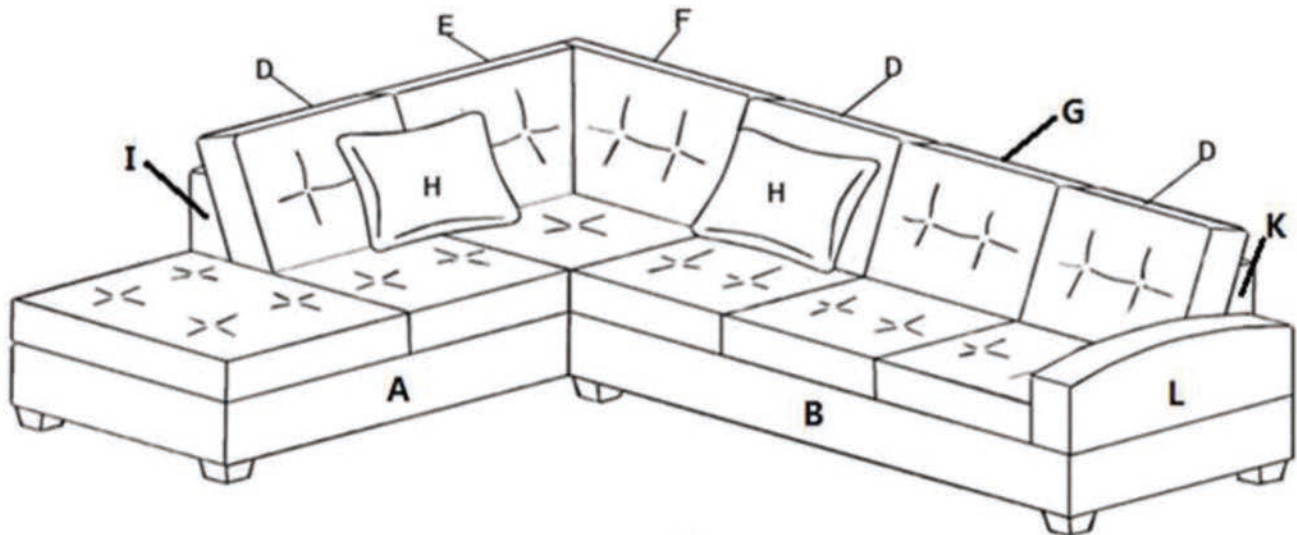

STEP 7:
PUT ALL THE PILLOWS TO THE SOFA AND CHAISE UNTIL NOW IS COMPLETED.