

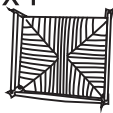





Ax1 	Bx1 	Cx2 	Dx8  6x16mm
Ex4 	Fx1 		

SPARE (Ersatzteile)

Dx1  6x16mm	Ex1 
-----------------------------------------------------------------------------------------------------	--------------------------------------------------------------------------------------------

STEP 1

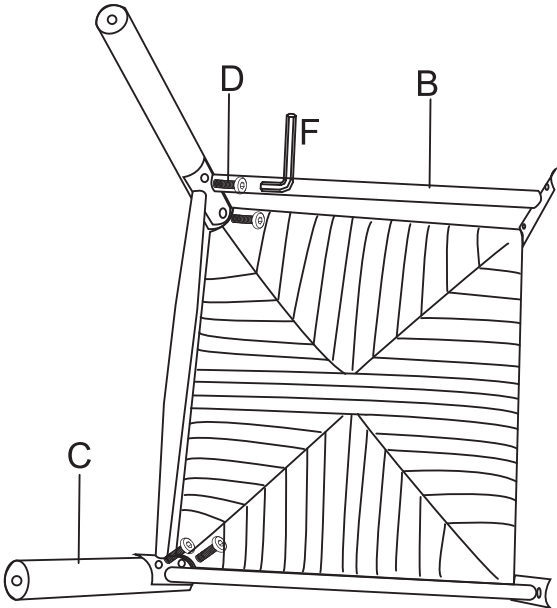

STEP 2

