

# Owner Manual

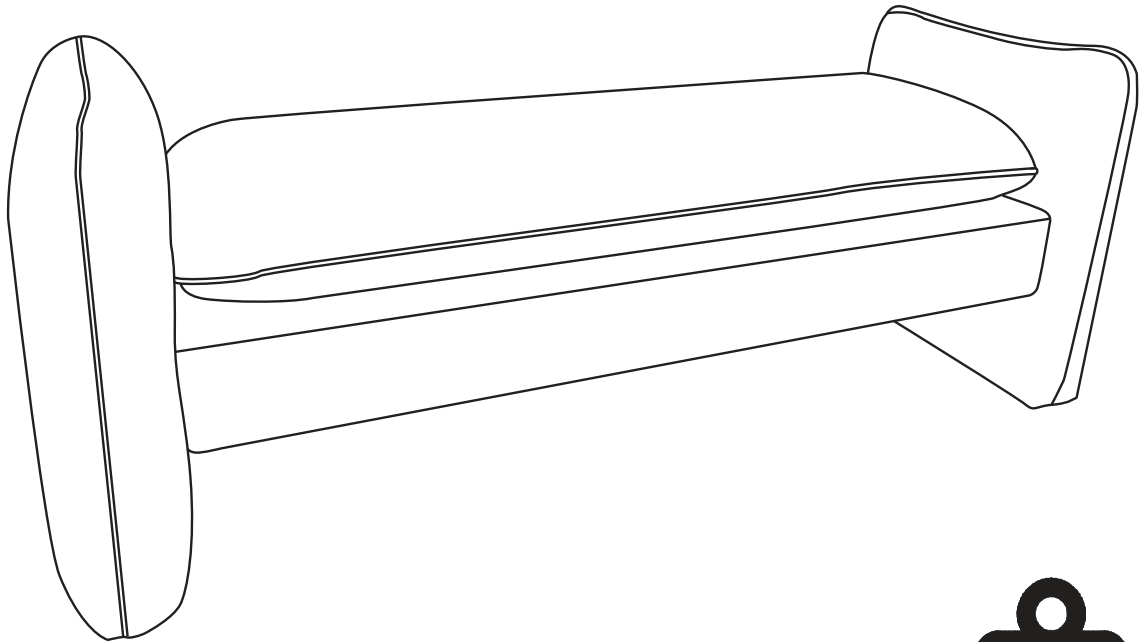

Per Seat Weight Limitation

**500 LBS**

---

**Thank You For Choosing Our Furniture**

▾ If you have any questions or concerns,  
don't hesitate to reach out to us. ▴

## **NOTE:**







**This brochure contains  
IMPORTANT safety info.  
Please read and keep it  
for future reference.**

# MAINTENANCE AND WARNINGS



## Before You Start

*Please follow the steps below:*



-  **Un box the package and check if all parts and accessories are complete.**
-  **Place the parts of the chair on a flat surface.**
-  **Ensure the chair is placed on a stable, flat surface to prevent it from tilting.**
-  **Avoid placing sharp or heavy objects directly on the chair to prevent tears or deformation.**
-  **Clean the installation area in advance and ensure the ground is level and there is enough space to avoid damaging the furniture or making installation difficult.**
-  **Lay a protective mat on the ground to prevent scratching the floor during installation.**

### After-Sales Service

- **If you encounter any issues or need technical support during use, please contact our after-sales team. We offer long-term maintenance and warranty services.**





## Precautions

-  This chair is for indoor use only. Do not expose it to outdoor elements or high-humidity environments.
-  Keep the product away from high heat or open flames to prevent fire hazards.
-  Do not allow children or pets to play on the chair unsupervised to avoid accidents.



## Safety Warnings

-  If you notice any loose or damaged parts, stop using the sofa immediately and contact customer service.
-  Do not attempt to disassemble or replace any components yourself, as this may affect the stability and safety of the product.



### Daily Maintenance

- Regularly clean the surface of the sofa with a chair cloth to prevent dust accumulation.
- For fabric chairs, it is recommended to vacuum weekly and clean the fabric as needed.
- For leather chairs, use a leather cleaner regularly to clean and maintain the material. Avoid direct sunlight to prevent leather aging.
- In case of spills, immediately blot the area with a clean, dry cloth

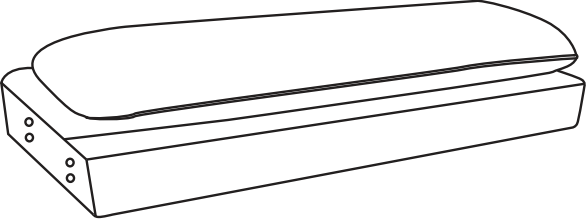
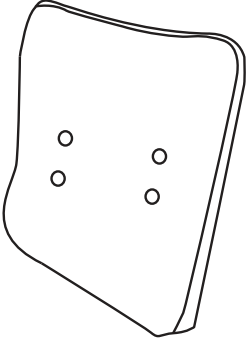

## Parts List

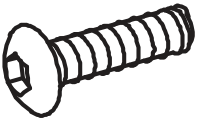
<p><b>A</b></p>  <p>Seat cusion x1</p>	<p><b>B</b></p>  <p>Arms x2</p>
---	---

## Hardware List

<p><b>1</b> X8</p>  <p>Bolt ø8x35mm</p>	<p><b>2</b> X8</p>  <p>Gaskets</p>	<p><b>3</b> X1</p>  <p>Allen Key M8</p>
---	---	--

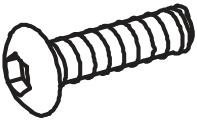
## Hardware Spare List

<p><b>1</b> X1</p>  <p>Bolt ø8x35mm</p>	<p><b>2</b> X1</p>  <p>Gaskets</p>	
--	---	--



Step 1

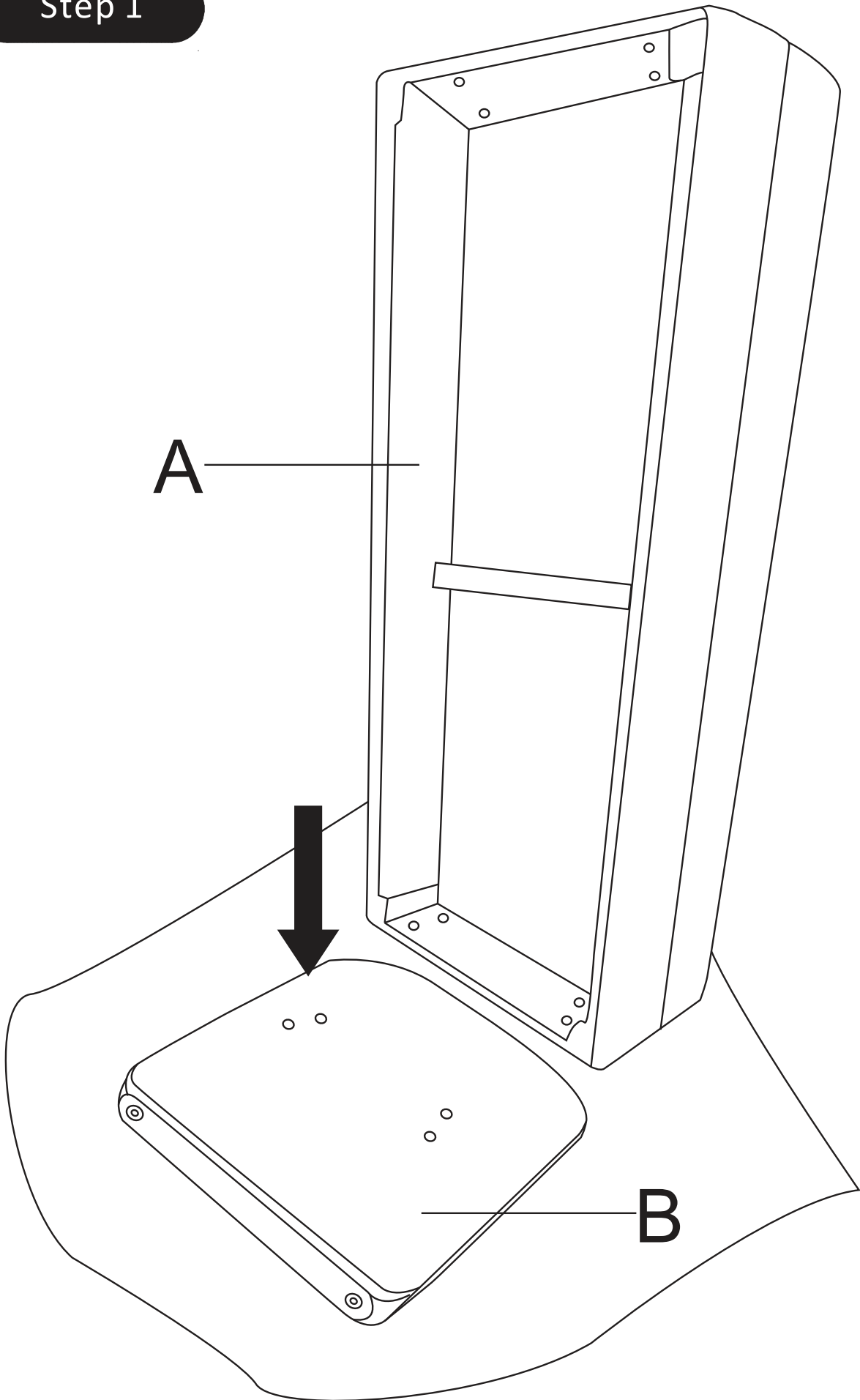

# Step 2

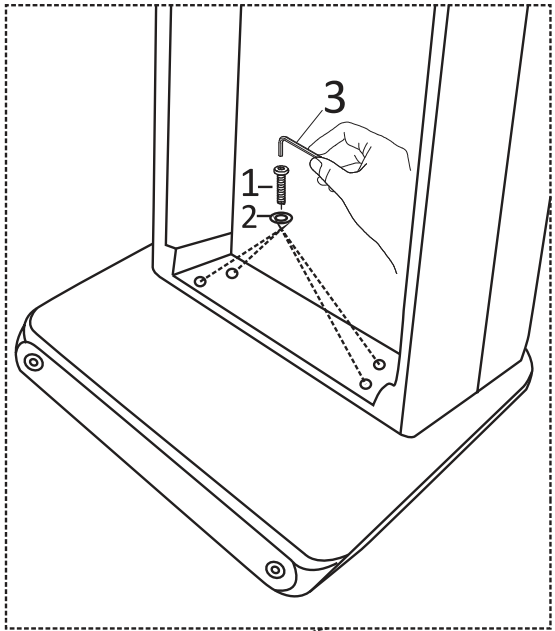
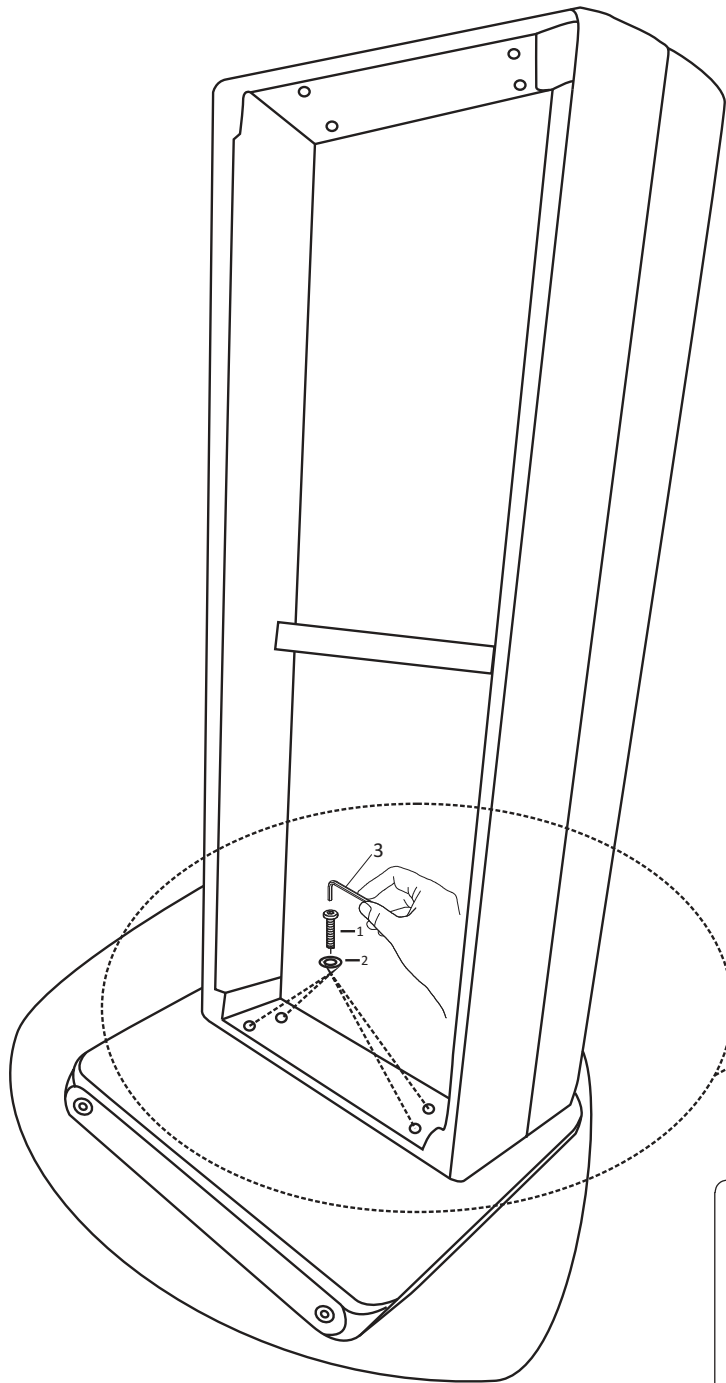

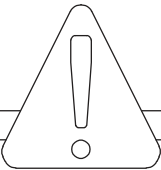
  
**Ensure the screws are 100% tightened to prevent loosening!**

# Step 3

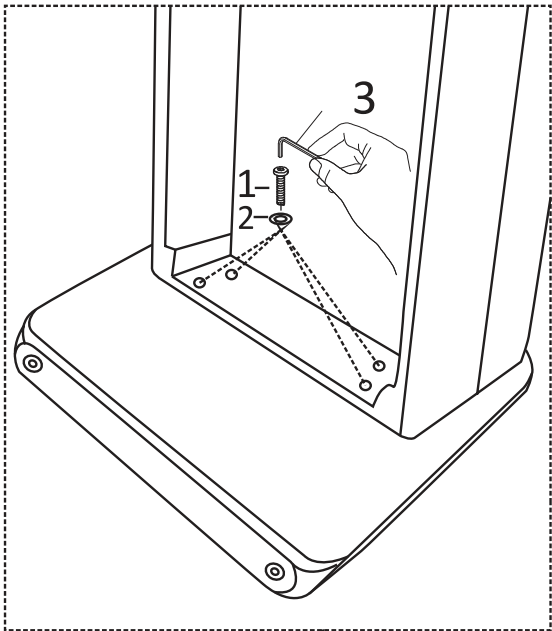
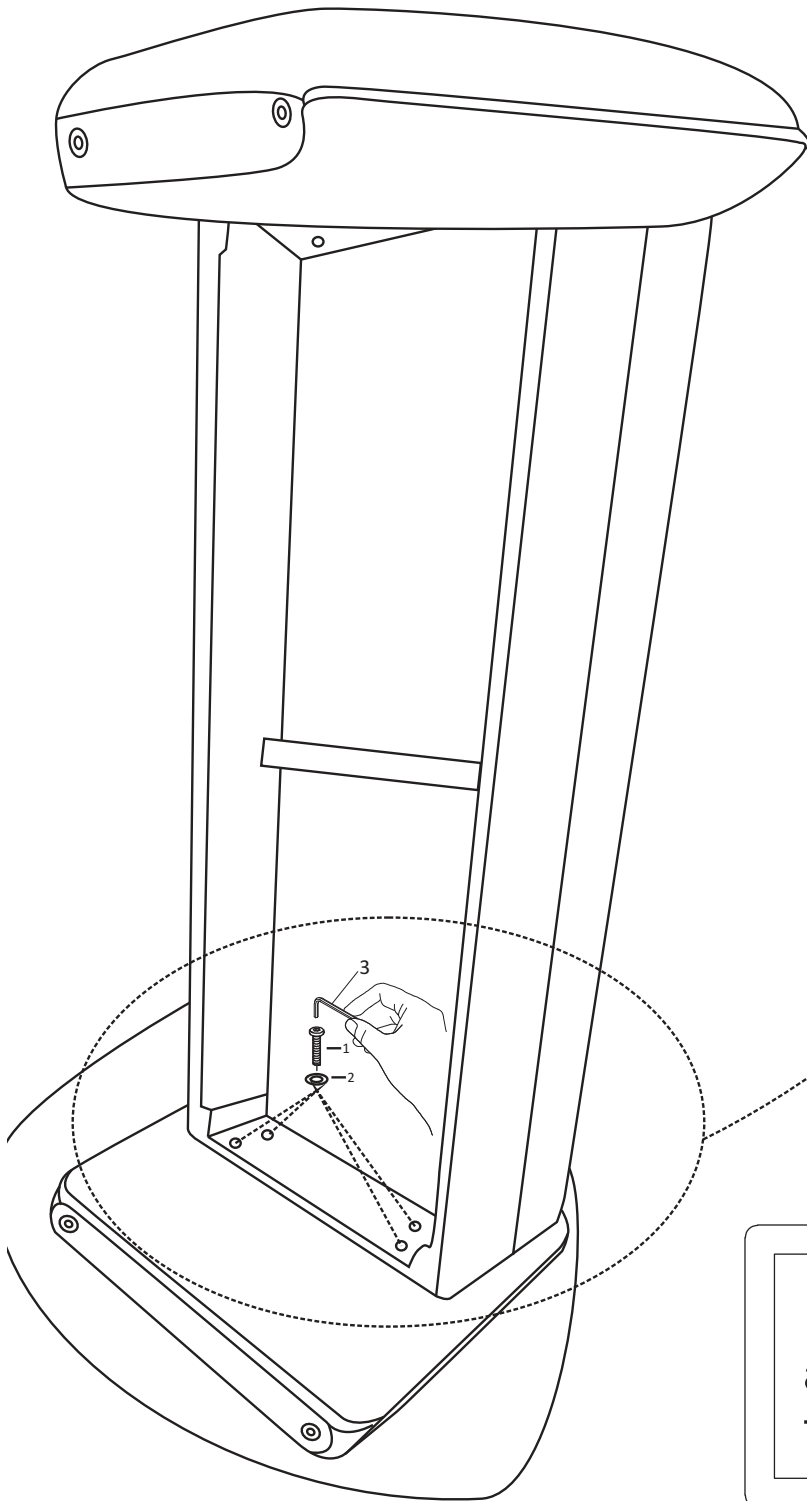

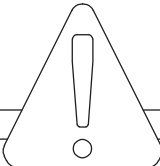
  
**Ensure the screws are 100% tightened to prevent loosening!**

Step 4

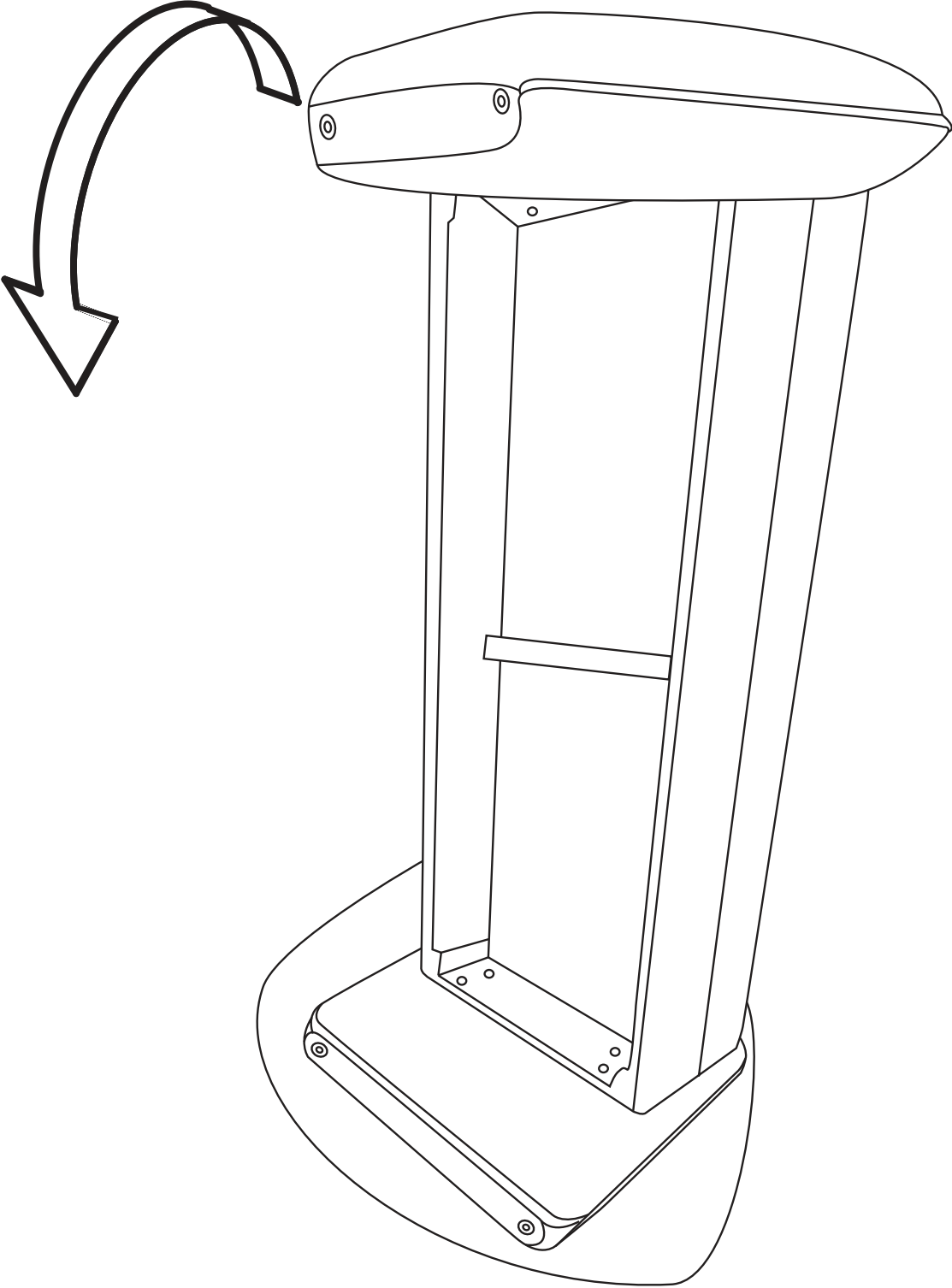

Step 5

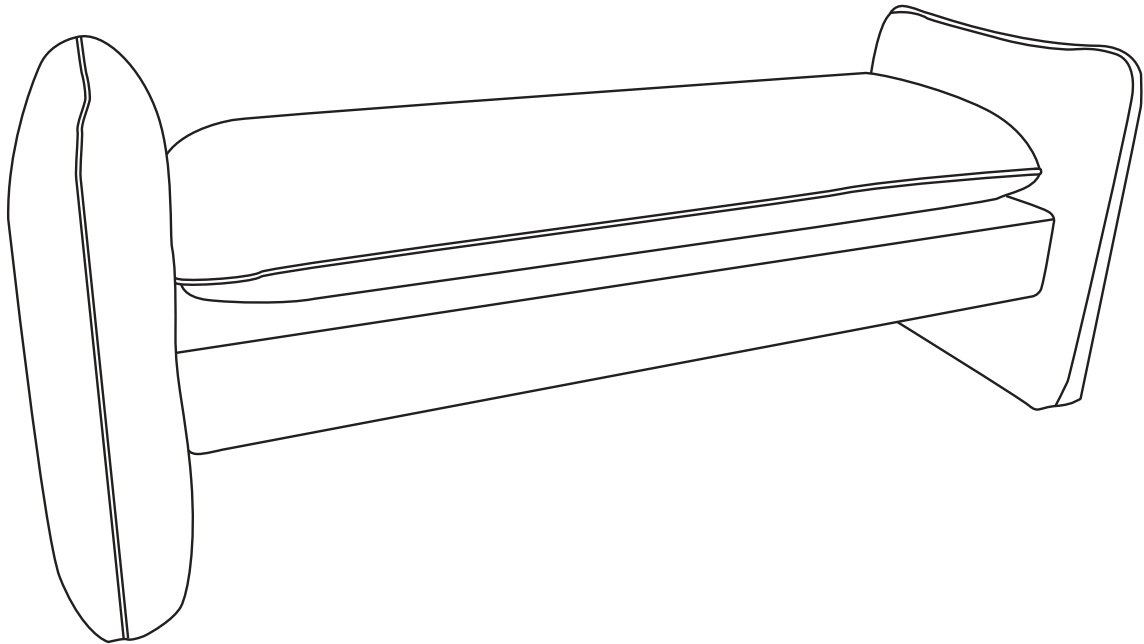

Assembly completed.

# WARRANTY

- We strive to offer quality products, and we also try our best to satisfy every customer who orders from us with products or services as needed.
- We provide 30 days warranty starting from the time you receive the item. Each customer must provide a record of their orders such as the order number, or item receipt for any items that are out of the warranty period you may also still receive.
- Replacement parts by purchasing them from our company if they are available.
- For return, please check the return policy with the retailer or market place you bought from.

**Appreciate your purchasing from us.  
Pop up your life by our furniture piece!**