

NOTICE

- * Please make sure that you have all parts indicated and they are in good condition before you begin assembly of this item. Refer to part list and hardware list below for guidance.
- * This item should be assembled on a soft surface to prevent scratching the finish during assembly.
- * Do not fully tighten the bolts until the product is assembled.
- * This item may require periodic tightening.
- * If you are having difficulty, our friendly Customer Care team is always here to help. Please email customersupport@safavieh.com





PREPARATION

- * Before beginning assembly of product, make sure all parts are present. Compare parts with part contents list and hardware contents list.
- * If any part is missing or damaged, do not attempt to assemble the product.
- * Estimated Assembly Time: 10 minutes.
- * Tools Required for Assembly (included): Allen Key

CARE AND MAINTENANCE

Leather surfaces on Safavieh Furniture should be dusted regularly with a dry or slightly damp soft cloth. Avoid using saddle soap or other cleaners. Leather desks and tabletops have a lacquer coating, therefore they can be lightly waxed. Suede surfaces should only be cleaned with a dry, stiff brush. Exposure to liquid spills should be avoided since suede cannot be washed or cleaned like leather. 100% Safavieh Bicast Leather.

Part List and Hardware List

PIECE	DESCRIPTION	PICTURE	QUANTITY
A	SEAT		1X
B	LEG		1X
HW 1	HEXBOLT: M6X1X20MM		4X
HW 2	ALLEN KEY		1X

SAFAVIEH FURNITURE

Model# BST7511

Product Dimensions:19.7"Wx21.7"Dx38"H

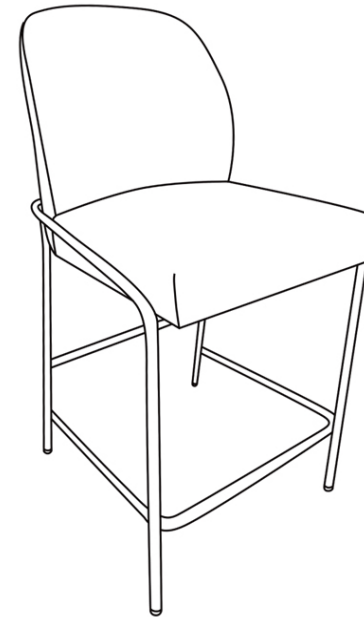

Weight capacity- 275LBS

WARNING: Do not stand on the Chair.

WARNING: Do not over touque bolts.

PREPARATION

- * Before beginning assembly of product, make sure all parts are present. Compare parts with part contents list and hardware contents list.
- * If any part is missing or damaged, do not attempt to assemble the product.
- * Estimated Assembly Time: 10 minutes.
- * Tools Required for Assembly (included): Allen Key
- * If you are having difficulty, our friendly Customer Care team is always here to help. Please email customersupport@safavieh.com

1

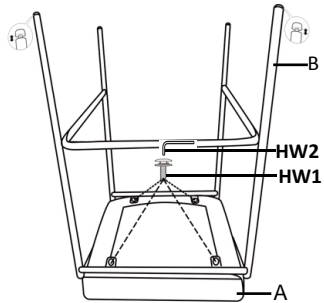

Step 1

Use the Allen Key(HW2) attach the leg(B) on the seat(A) backside with 4 screws(HW1).

2

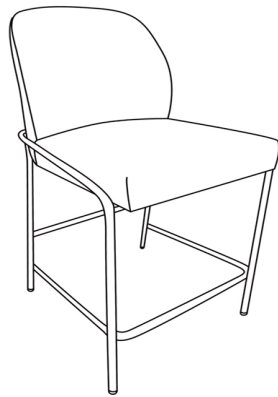

Step 2

Finished the whole assemble