

PATIO DINING CHAIR ASSEMBLY MANUAL

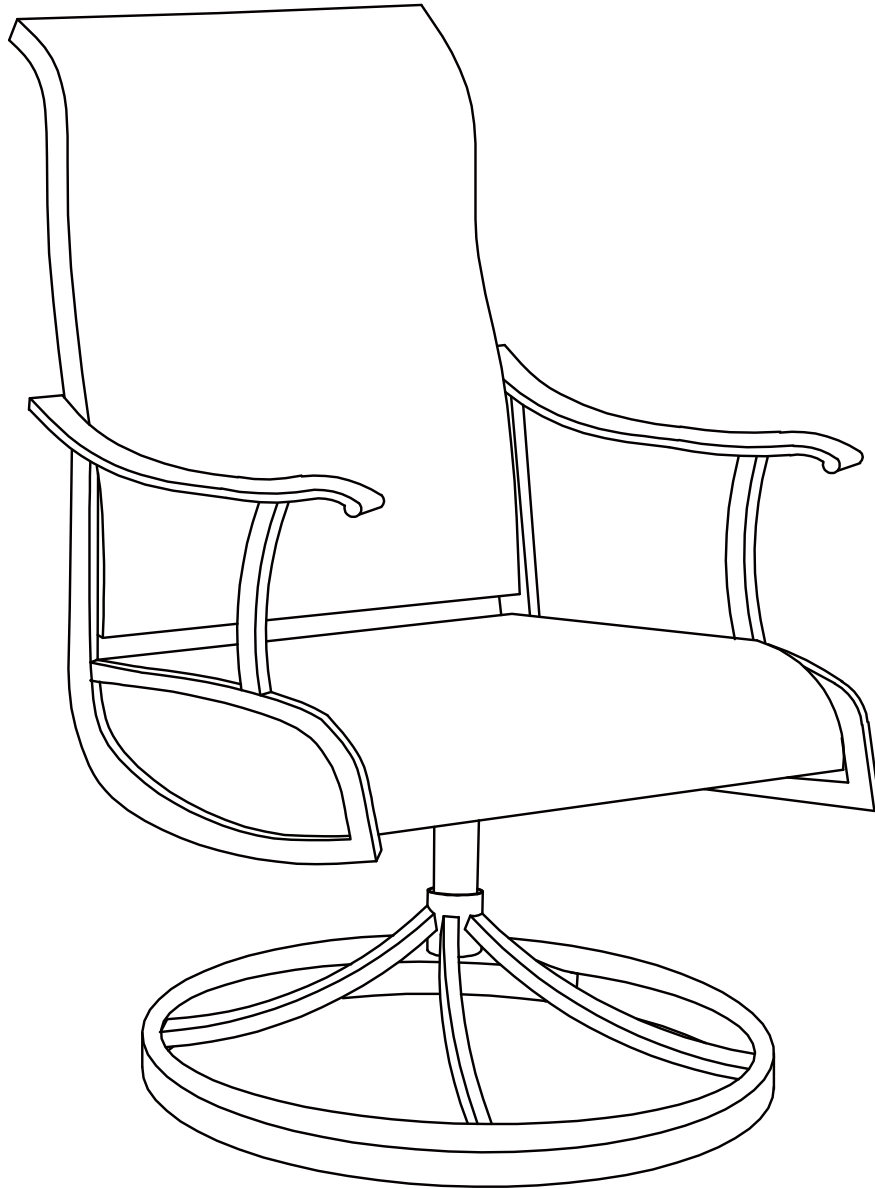

Dear Customer,

Thank you for choosing our product. Please read this manual carefully before assembling or using this product. If there are parts missing, please kindly send us messages to let us know the name of missing part regarding to the Parts List of instructions. We will send replacement to you asap.

PARTS LIST



NOTE!

This icon means how tight the screws should be tightened. Please follow this icon to ensure the installation is complete.

TOOLS REQUIRED

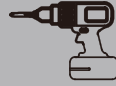

POWERDRILL



2 PERSON
ASSEMBLY









UP TO 15 MIN
ASSEMBLY

1PC	1PC	1PC	1PC	1PC
		<p>M6x35MM</p>	<p>M8x35MM</p>	<p>M6</p>
1PC	2PCS	8PCS	4PCS	8PCS
<p>M8</p>	<p>M8</p>	<p>M8</p>	<p>M6</p>	<p>M8</p>
4PCS	4PCS	4PCS	1PC	2PCS

STEP 1

Attach part F to seat C first, then secure part F with parts P/M/N/H/J.

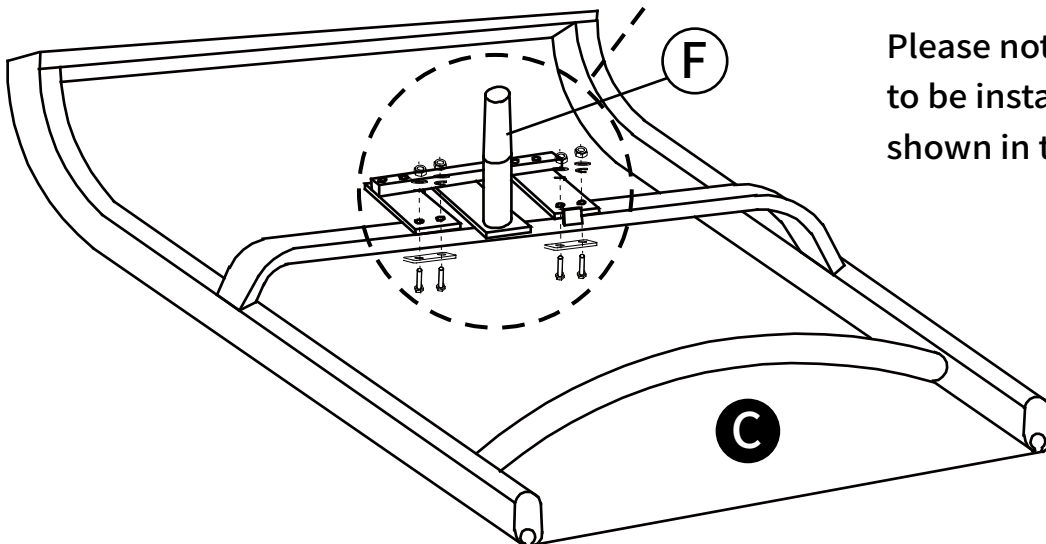
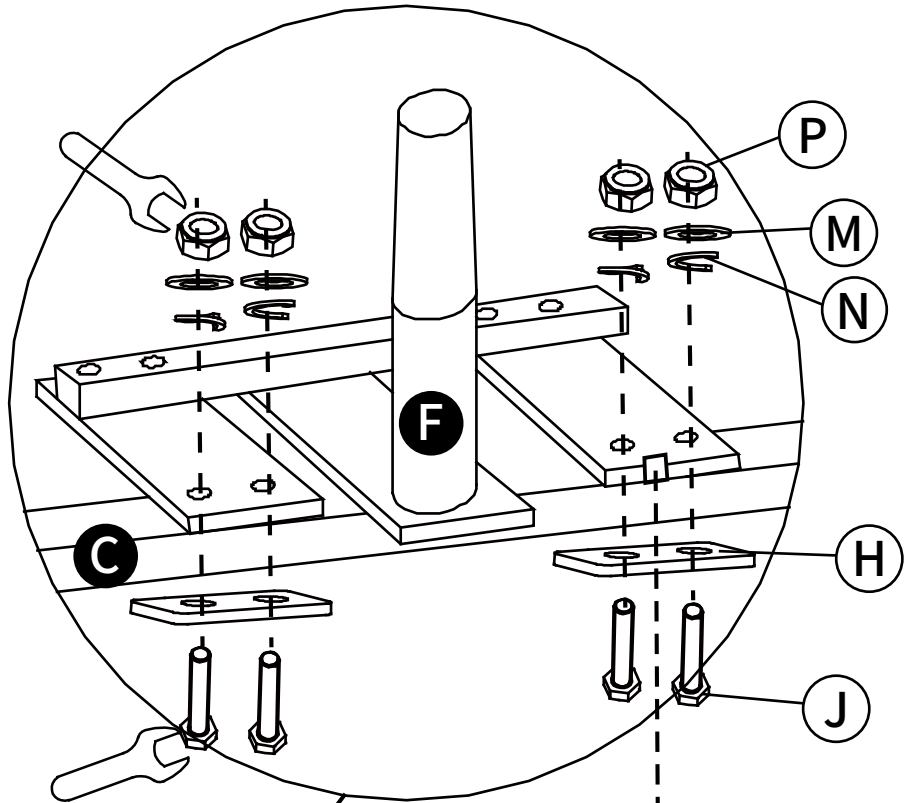

P		4PCS
M		4PCS
N		4PCS
H		2PCS
J		4PCS
F		1PC
C		1PC



Please note that part F needs to be installed in the direction shown in the illustration.

STEP 2

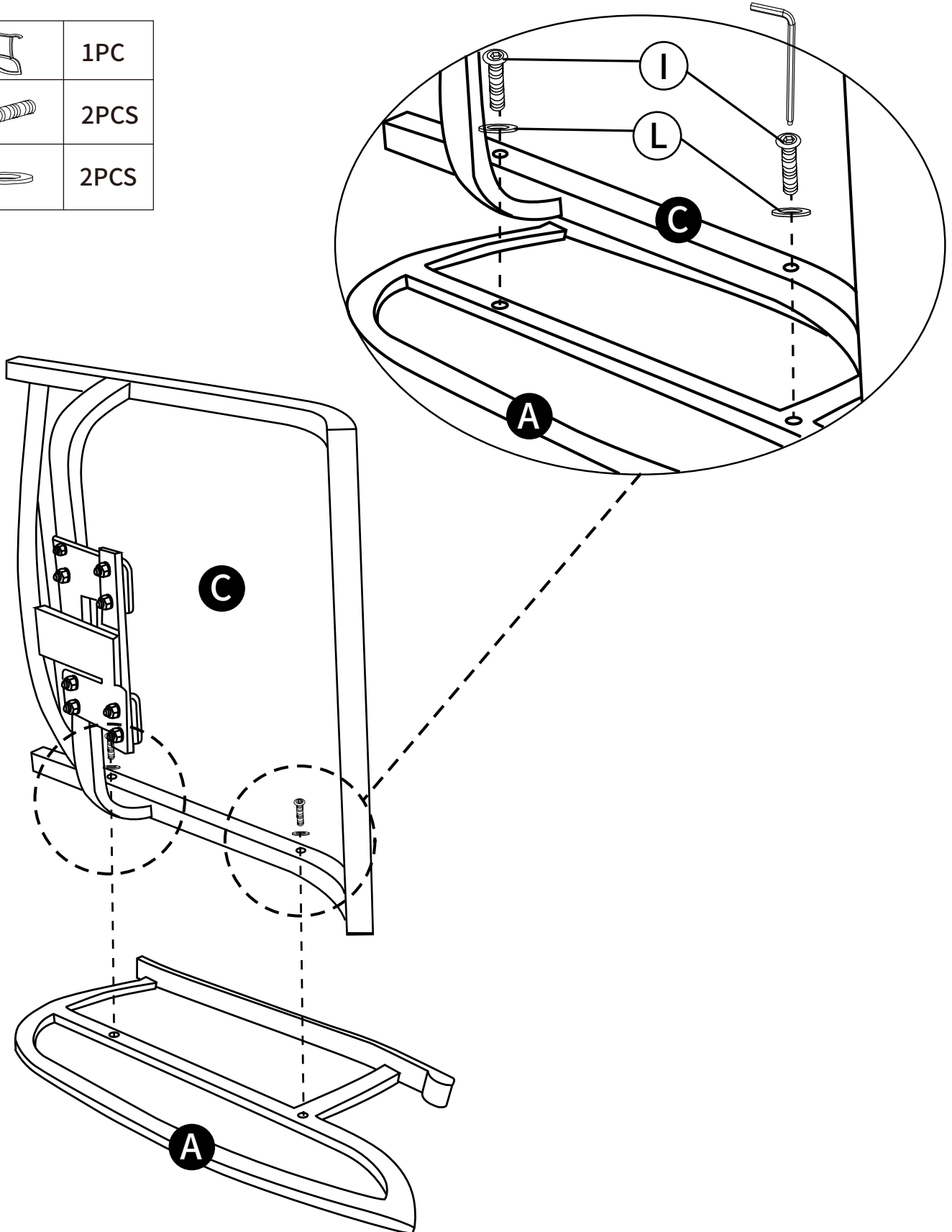
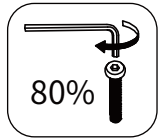

Place the armrest A on the ground in the orientation shown, then align the 2 holes in the seat and armrest. Secure the seat C and armrest A with 2 screws I and 2 spacers L.

A		1PC
I		2PCS
L		2PCS



STEP 3

Place the armrest B on the ground in the orientation shown, then align the 2 holes in the seat and armrest. Secure the seat C and armrest B with 2 screws I and 2 spacers L.

B		1PC
I		2PCS
L		2PCS

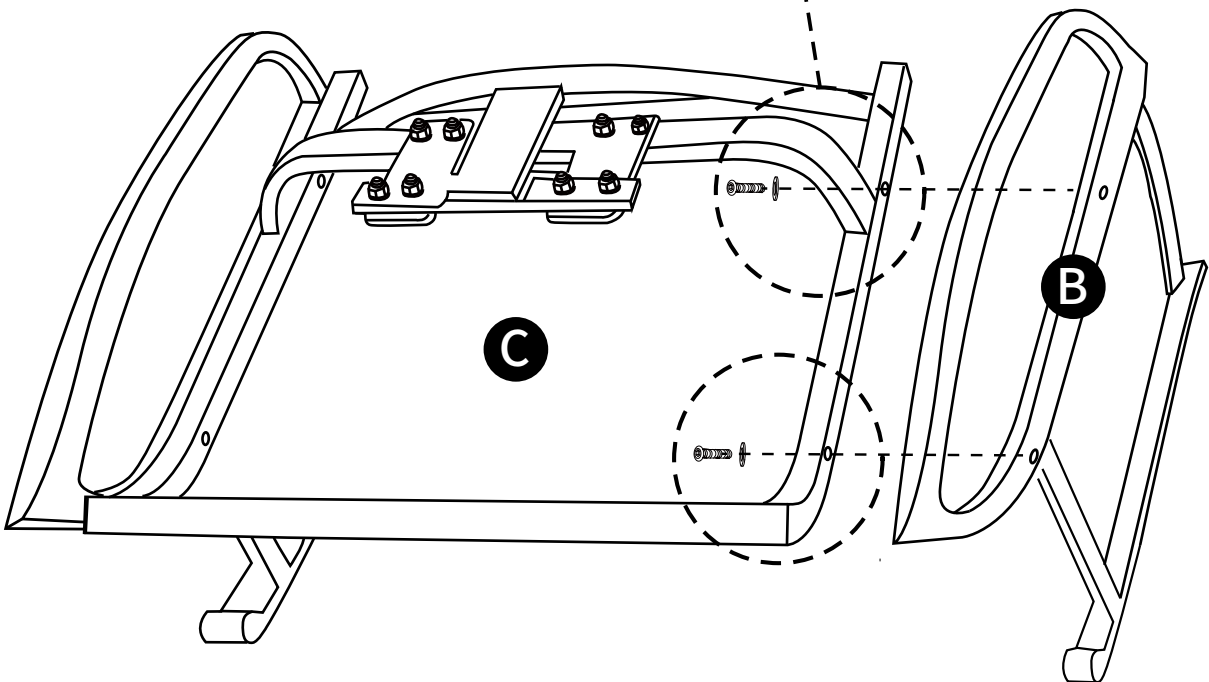
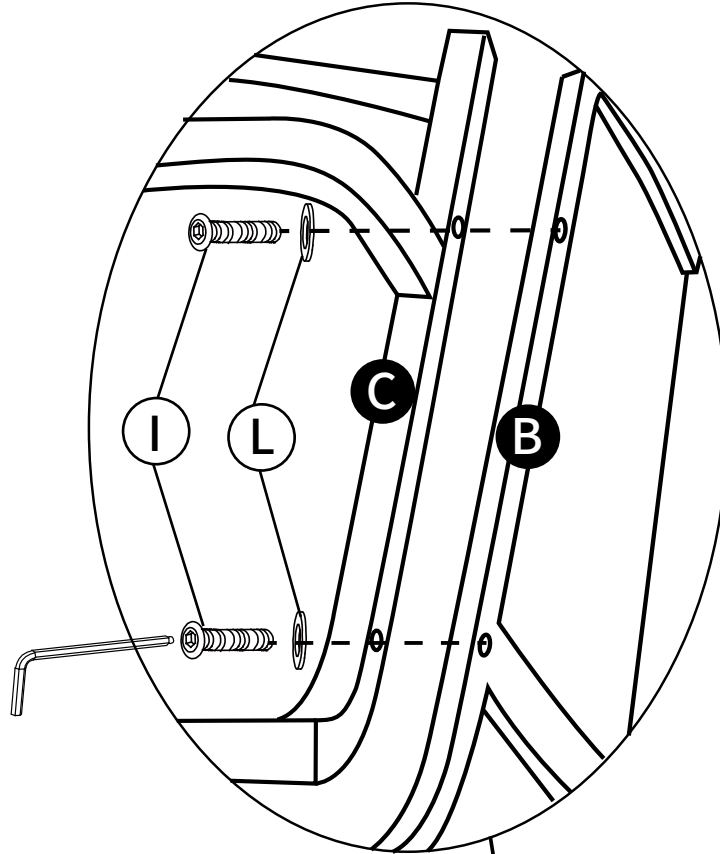
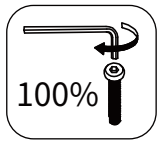

STEP 4

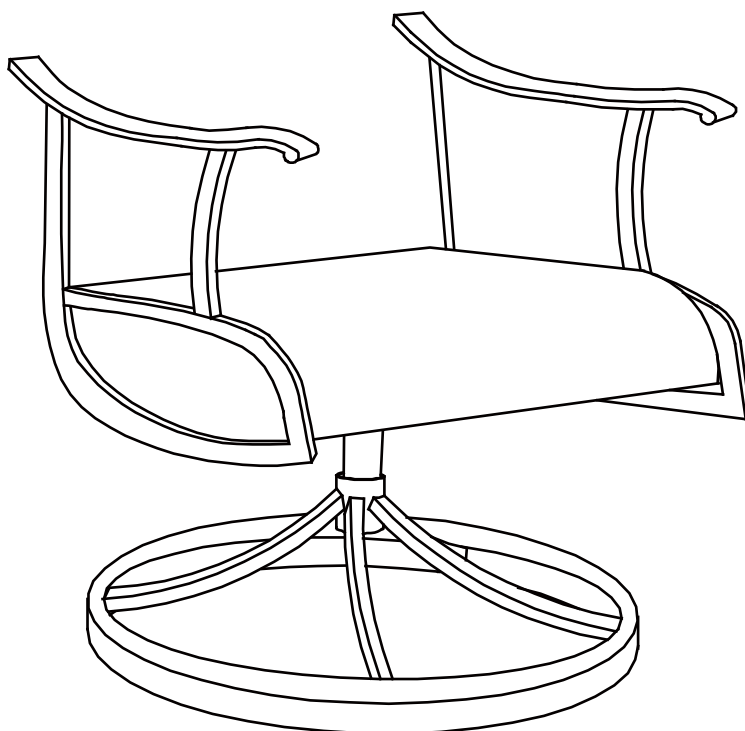
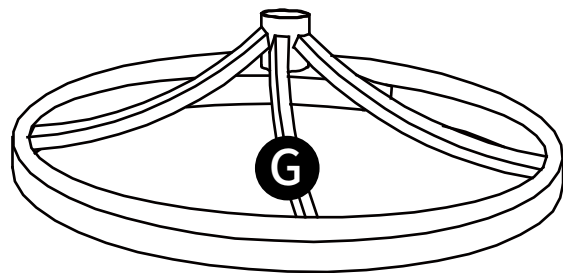
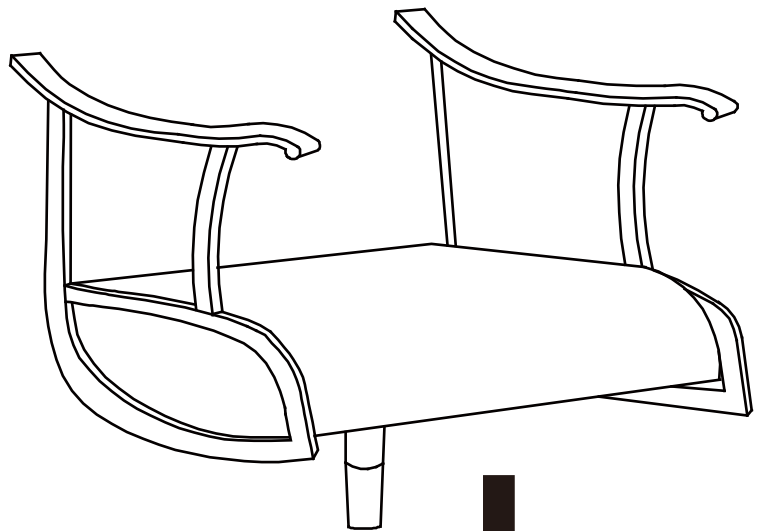

Insert seat C into chassis G.

G		1PC
---	---	-----



STEP 5

Secure armrests and backrest D with 4 screws I and 4 spacers L.

D		1PC
I		4PCS
L		4PCS

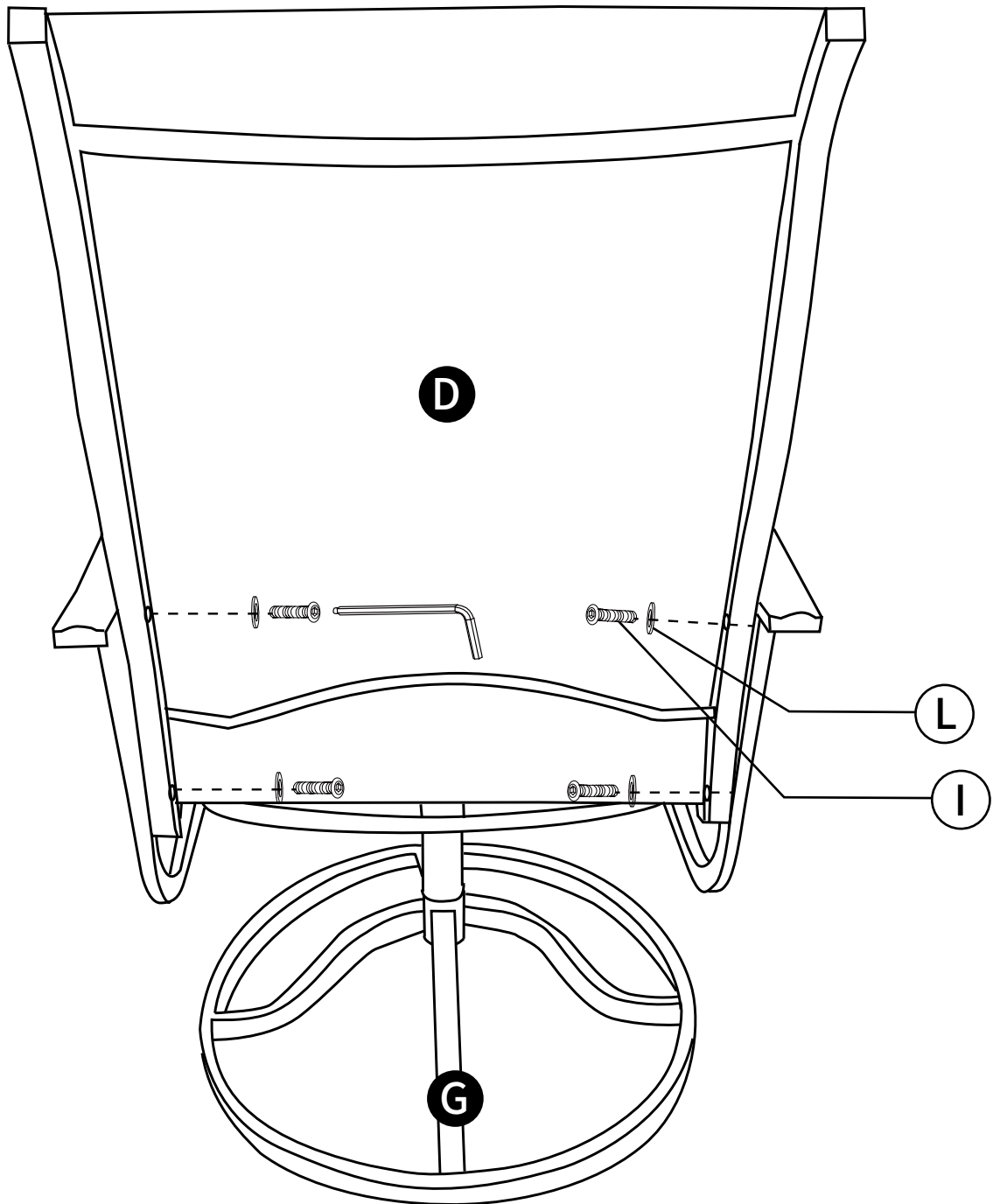
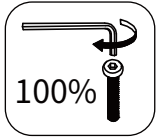

STEP 6

The chair is assembled and can be swivelled 360 degrees.

