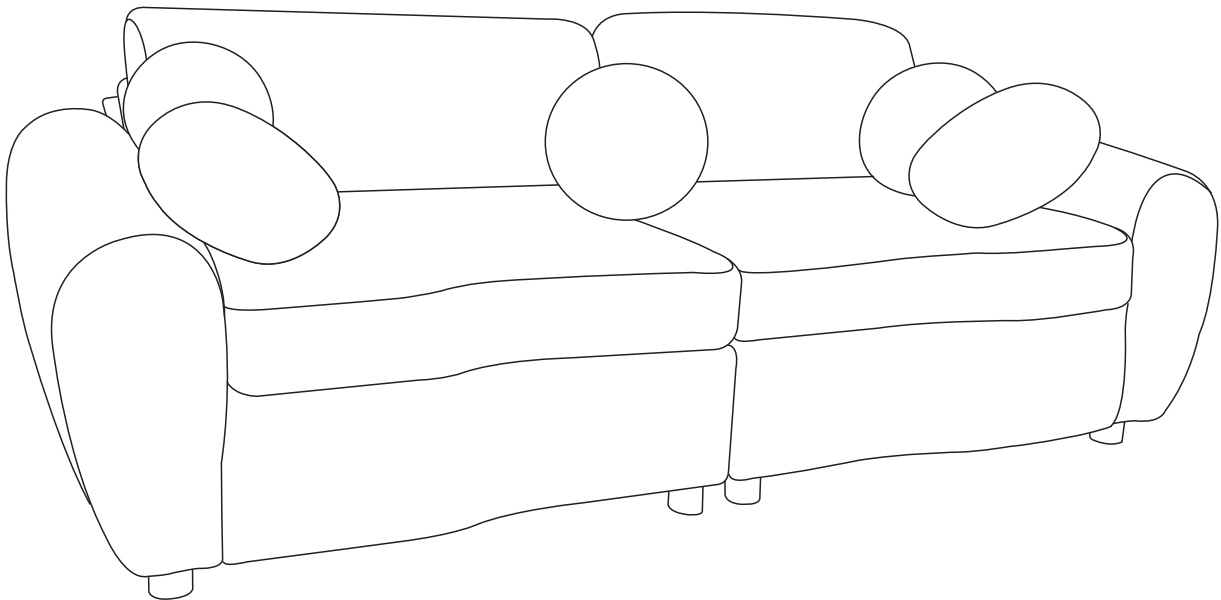


# ASSEMBLY INSTRUCTION

Friendly Reminder.

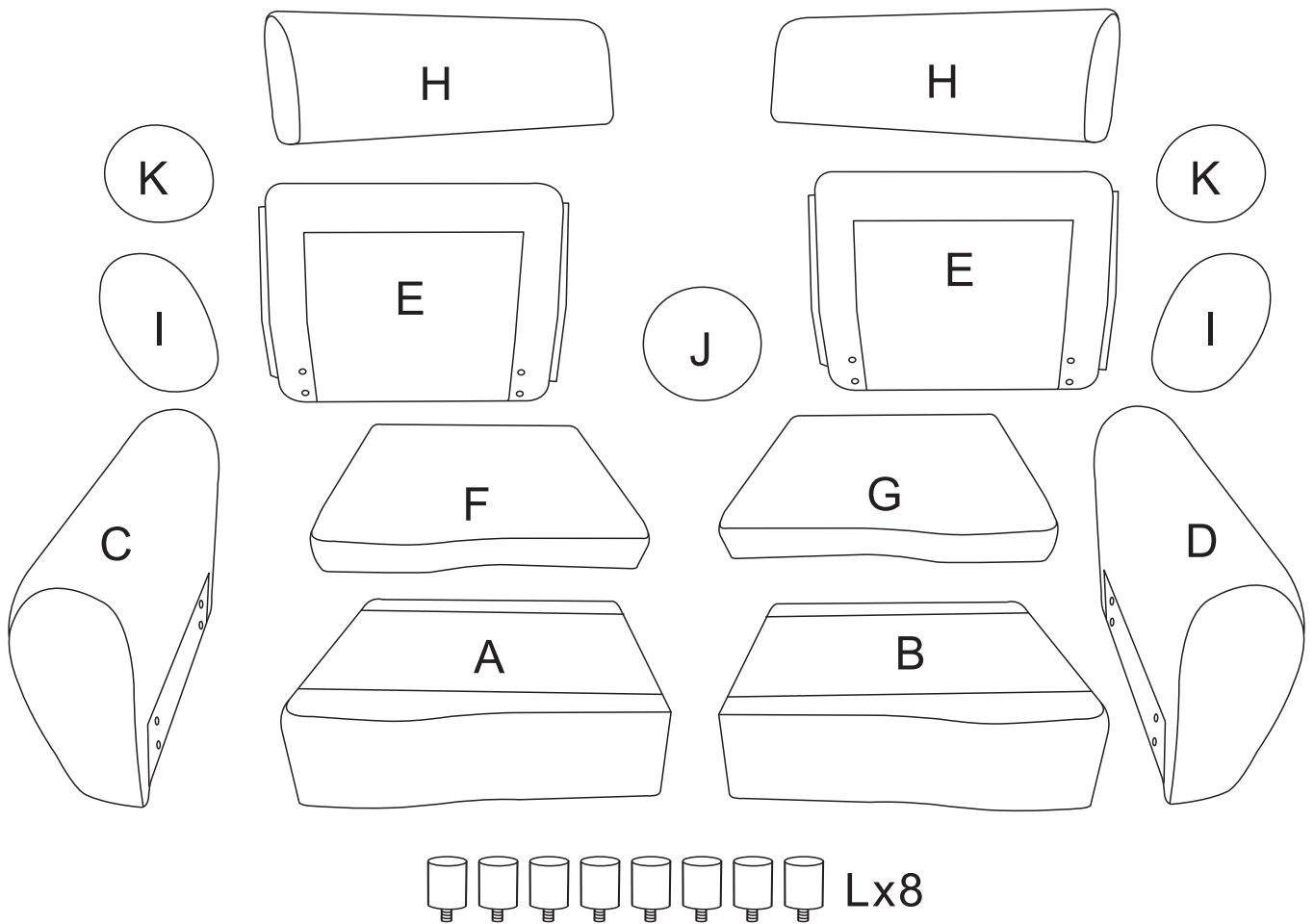
- 1.This sofa is packed in 2 boxes. Please assemble it After all boxes are received.
- 2.As the cushions are all vacuum compressed,there will be some wrinkles. Please give your cushions up to 72 hours to reach its original size and the wrinkles will basically disappear.
- 3.Please do not open the compressed packages until your sofa frame is completely assembled.



Return & Warranty policy:

- We strive to offer the highest quality products,and we also try our best to satisfy each and every customer that orders from us with replacement parts or service as needed.
- If the item is damaged or defective, please take photos as evidence for replacements and refunds.
- Please do not return to store,contact the seller if you have any troubles with this product.

# All parts and hardwares



## Hardware Package

1  16xScrews 8x40

2  16xWasher

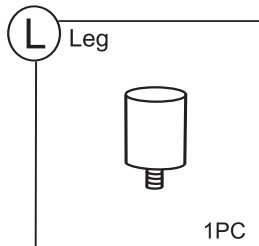
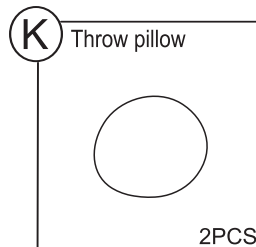
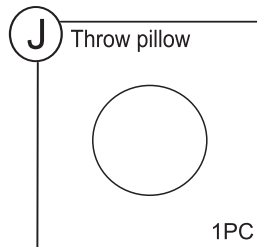
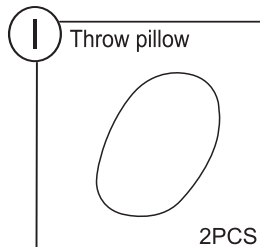
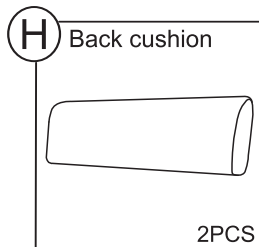
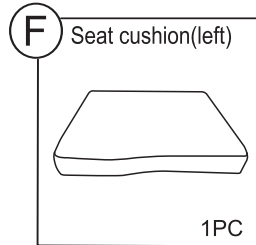
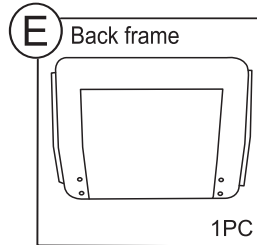
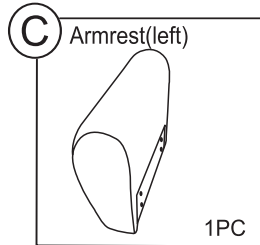
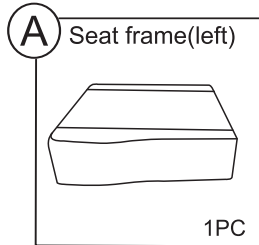
3  8x Non-slip pad

4  1xWrench

NOTE: Take out of all parts from 2 boxes, make sure all parts you have received before assembled.

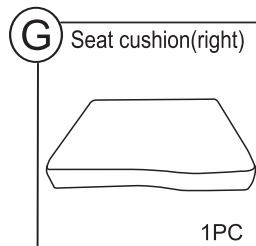
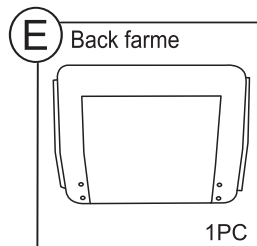
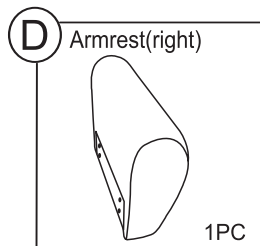
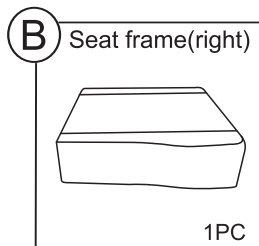
# COMPONENTS

## BOX 1

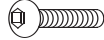




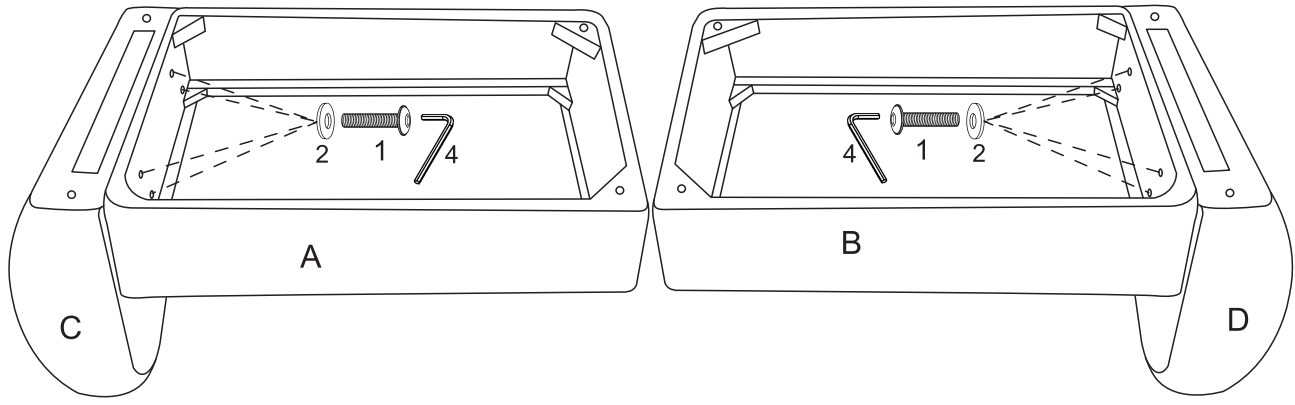
Hardware  
+  
Manual

## BOX 2

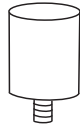



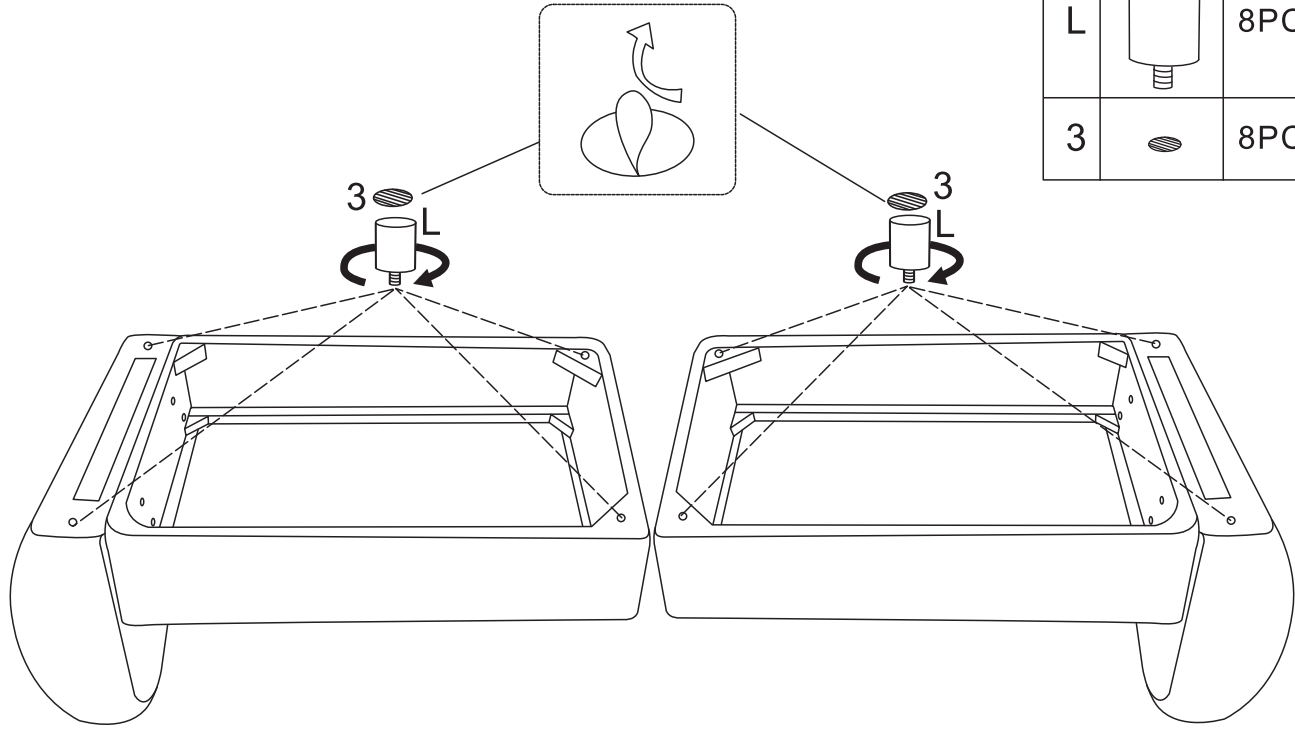
**DIAGRAM 1 (Assemble the Armrest to the Seat frame)**  
 Connect the Armrest(Part C&D) to the Seat frame(Part A&B) with the Screws M8X40mm (Hardware 1) and the Washers (Hardware 2) by Wrench (Hardware 4).

|   |   |      |
|---|---|------|
| 1 |  | 8PCS |
| 2 |  | 8PCS |
| 4 |  | 1PC  |



**DIAGRAM 2 (Assemble the Legs)**

|   |   |      |
|---|---|------|
| L |  | 8PCS |
| 3 |  | 8PCS |



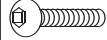


### DIAGRAM 3 (Assemble the Back frame)

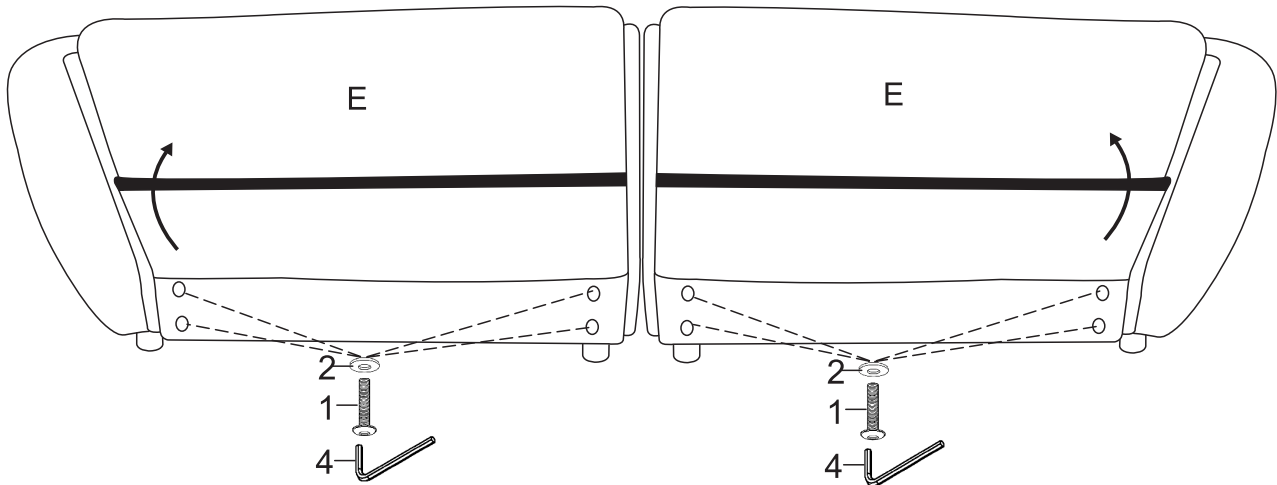
Connect the Back frames (Part E ) with Screws M8x40mm(Hardware1) and Washers (Hardware2) by Wrench(Hardware4) as shown.

Then put Velcro pieces together.

Please install the top Screws first, then the bottom Screws.

Make sure all the Screws are in the holes before tightening them.

|   |   |      |
|---|---|------|
| 1 |  | 8PCS |
| 2 |  | 8PCS |
| 4 |  | 1PC  |



### DIAGRAM 4 (Connecting the Seat frame)

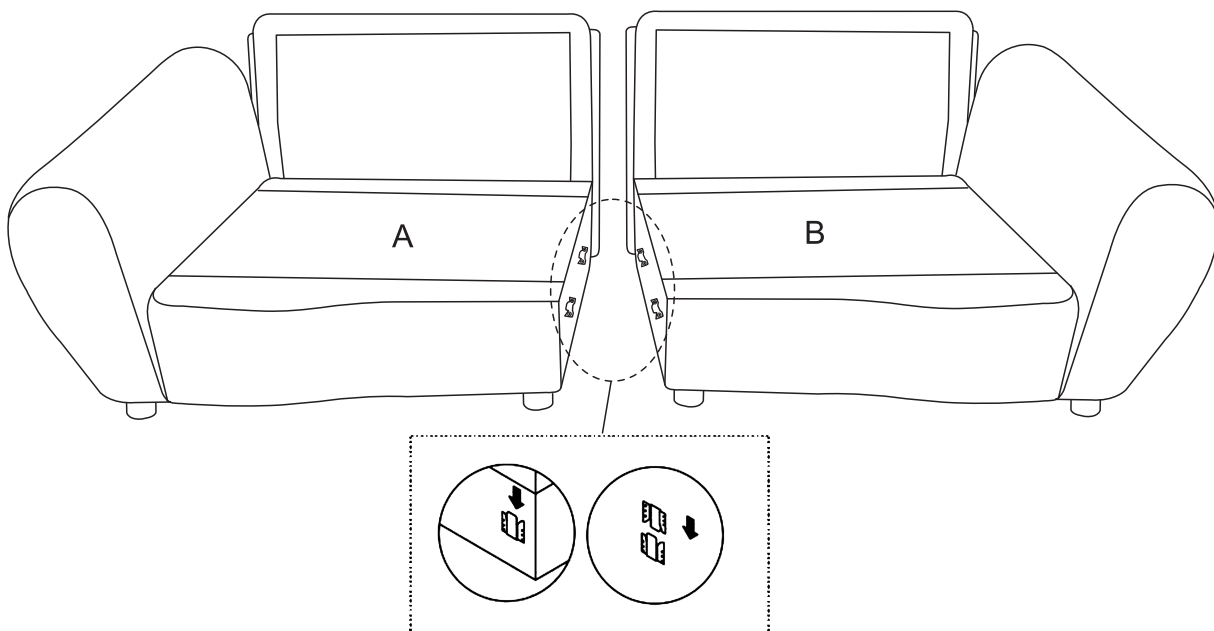
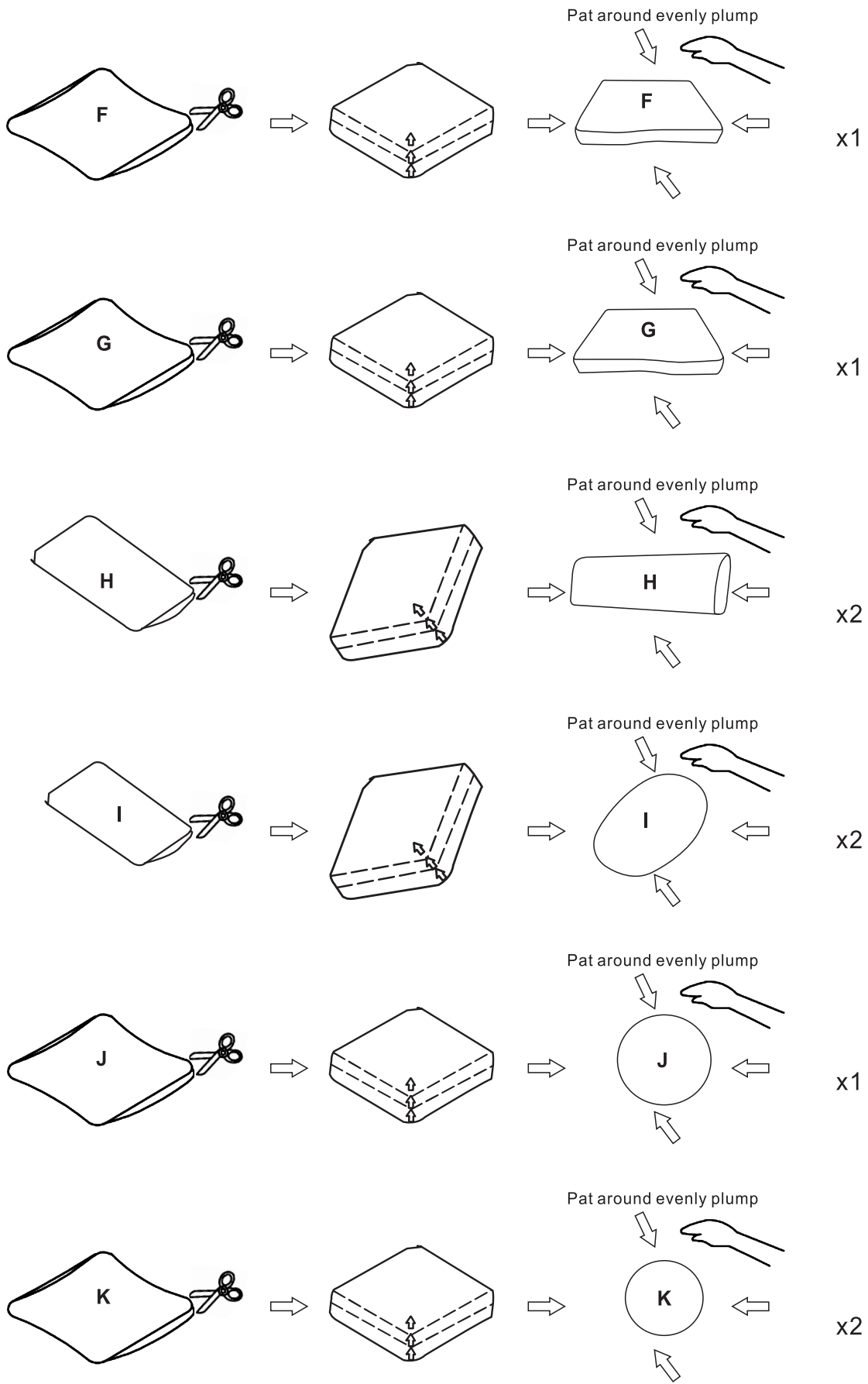
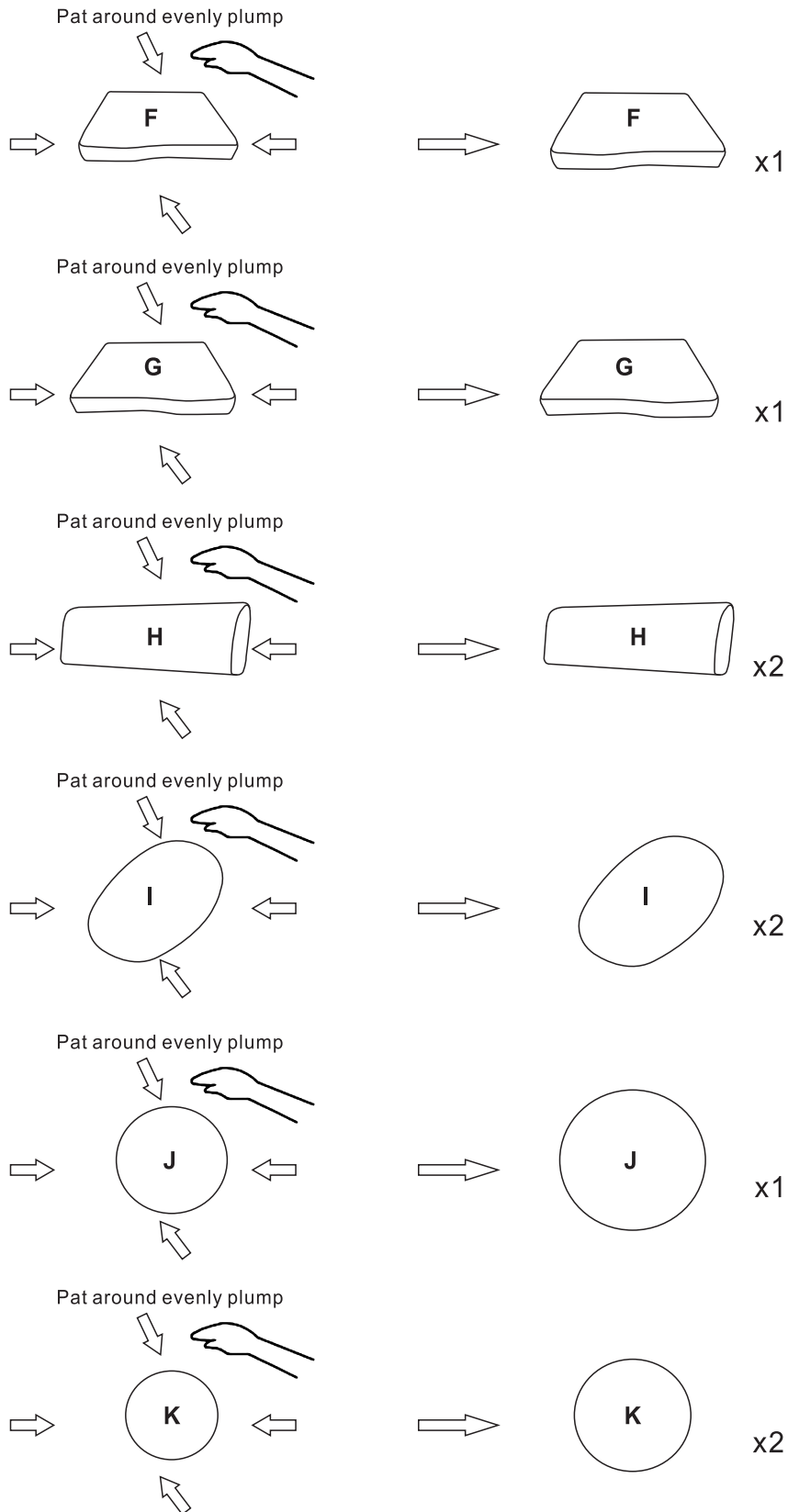


DIAGRAM5 (Removal of compressed bags)



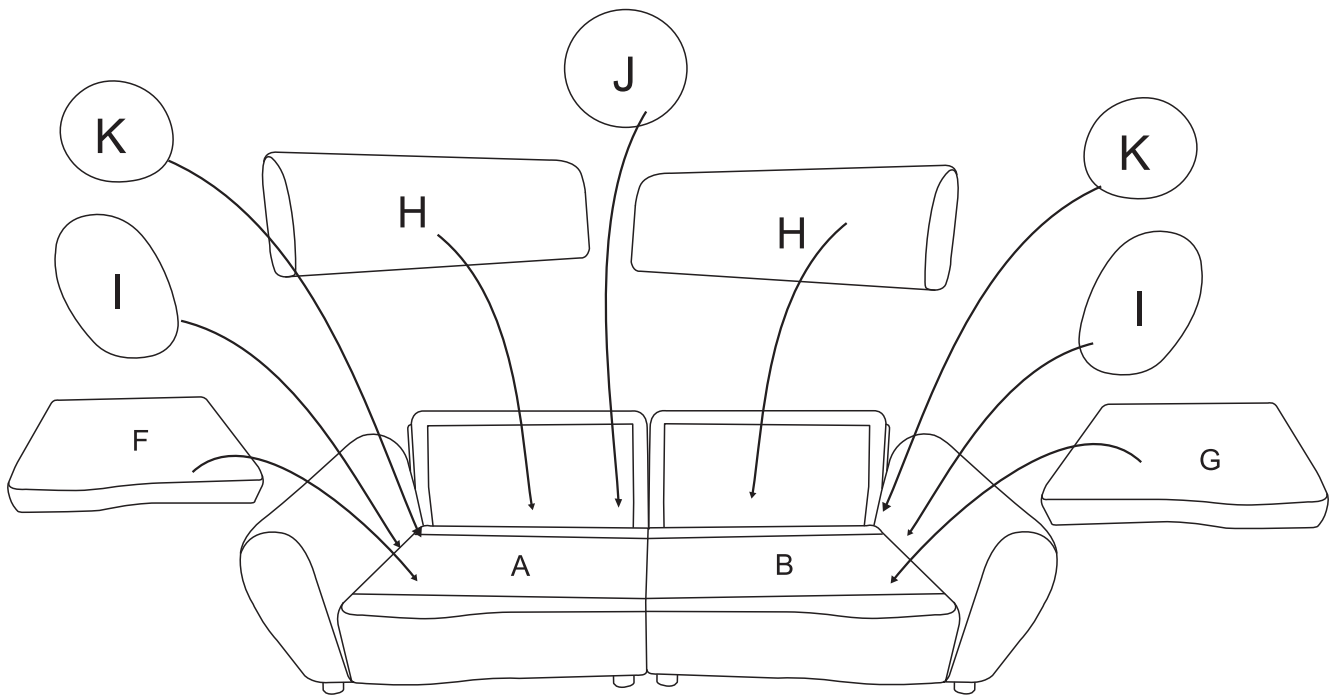
## DIAGRAM6 (Waiting for 72H)



### TIPS:

1. Please do not open the compressed packages until your sofa frame is completely assembled
2. Compressed Back cushions and Seat cushions need to be fully fulfilled within 72 hours for your perfect use.
3. Please keep children away from plastic bags or any small pieces of stuff.

DIAGRAM 7 (Place cushions and Throw pillows on the sofa frame)  
Place the Seat cushion, Back cushion and Throw pillows on the sofa frame.



COMPLETE

