











INSTALLATION INSTRUCTION

For Magic corner (left open door)

list of fittings

The rear frame	The side frame	Swivel arm	Door mounting bracket	Limit connection	M5*12	ST4*16	Big basket	Small basket
1 set	1 set	1 set	2 set (Dispart left and right)	1 set	2 pcs	20 pcs	2 pcs	2 pcs
			 M5*20 M5*8 M4*16		 M5*20 2 pcs 			

Step 1: Mount the extensible rear slide frame on rear and side panel.

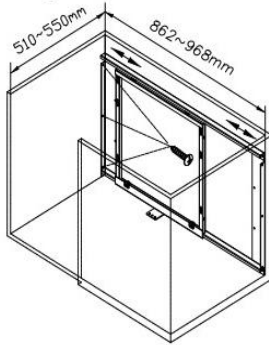

Step 2: Mark a line on side and bottom panel from front edge 7mm, keep the side frame in closed position and aim A point on line.

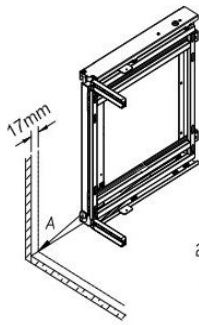

Step 3: Pull-out the side frame in open position, and mounting the side frame on side and bottom panel.

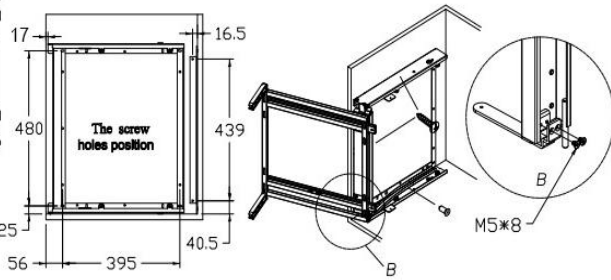

Step 4: Connect side frame and rear slide frame by swivel arm, and firm door mount bracket on pull-out side frame.

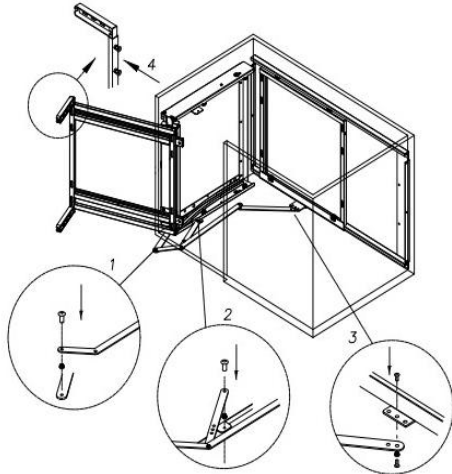

Step 5: Mark the screw holes on door panel, and screw two brackets on door panel. Connect door panel with pull-out side frame by door mount bracket.(m/m)

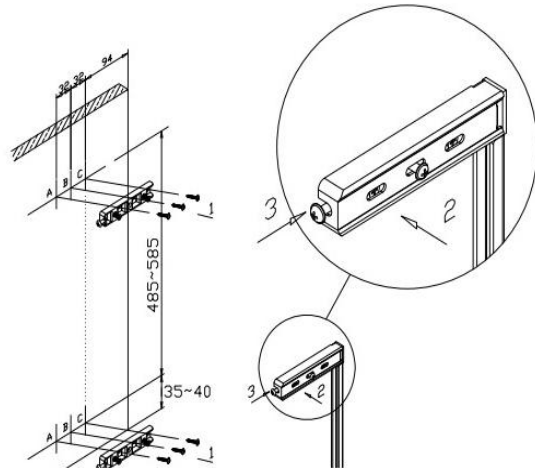

Adjusting closure pitch of cabinet door by the door mounting bracket, then fixup all screws. (Pay attention to assembly swivel arm, for left and right mounted door mirror image)

