

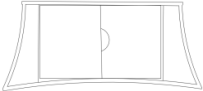







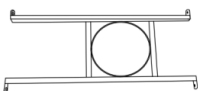
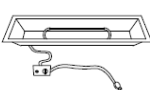

# PACKAGE CONTENTS

	PART	DESCRIPTION	QTY
A		FIREPIT TABLETOP	1
B		FRONT PANEL	1
C		BACK PANEL	1
D		LEG 1	1
E		LEG 2	1
F		BOTTOM SUPPORT	1
G		RECTANGULAR BRAZIER	1
H		BURNER COVER	1
I		1/4"*18 BOLTS	16
J		M5*25 BOLTS	4
K		WASHERS	16
L		M5	4
M		GLASS A	2
N		GLASS B	2
O		CLIP	8
P		GLASS	1
Q		HEX BOLT DRIVER	1

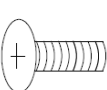
## SAFETY INFORMATION

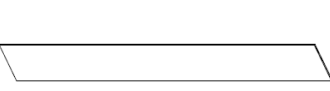
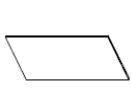

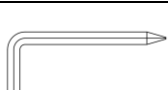
### DANGER FIRE OR EXPLOSION

If you smell gas:

- Shut off gas to the appliance.
- Extinguish any open flame.
- If odor continues, leave the area immediately.
- After leaving the area, call your gas supplier or fire department.

Failure to follow these instructions could result in fire or explosion, which could cause property damage, personal injury, or death.



**WARNING**  
Do not store or use gasoline, or other flammable vapors and liquids, in the vicinity of this or any other appliance.  
An LP-cylinder not connected for use shall not be stored in the vicinity of this or any other appliance.



**WARNING: For Outdoor Use Only.**  
Installation and service must be performed by a qualified installer, service agency, or the gas supplier.

**INSTALLER:** Leave this manual with the appliance.  
**CONSUMER:** Retain this manual for future reference.

**WARNING:** If the information in this manual is not followed exactly, a fire or explosion may result causing property damage, personal injury, or loss of life.



### DANGER



#### CARBON MONOXIDE

This appliance can produce carbon monoxide which has no odor.

Using it in an enclosed space can kill you.

Never use this appliance in an enclosed space such as a camper, tent, car or home.

# SAFETY INFORMATION

---

## SAFETY INFORMATION

Please read and understand this entire manual before attempting to assemble, operate or install this appliance.

The installation must conform to local codes or in the absence of local codes, to the National Fuel Gas Code, ANSI Z223.1 • NFPA 54; National Fuel Gas Code; Natural Gas and Propane Installation Code, CSA B149.1; or Propane Storage and Handling Code, CSA B149.2. This manual contains important information about the assembly, operation and maintenance of this patio heater. General safety information is presented in the first few pages and is also located throughout this manual. Keep this manual for future reference and to educate new users of this appliance. This manual should be read in conjunction with the labeling on the appliance. Safety precautions are essential when any mechanical or propane fueled equipment is involved. These precautions are necessary when using, storing, and servicing. Using this appliance with the respect and caution demanded will reduce the possibilities of personal injury or property damage. The following symbols shown below are used extensively throughout this manual. Always heed these precautions, as they are essential when using any mechanical or propane fueled equipment.



### **DANGER**

**DANGER indicates an imminently hazardous situation which, is not avoided, will result in death or serious injury.**



### **DANGER**

**Failure to comply with the precautions and instructions provided with this fire pit can result in death, serious bodily injury and property loss or damage from hazards of fire, explosion, burn asphyxiation, and/or carbon monoxide poisoning. Only persons who can understand and follow the instructions should use or service this fire pit.**

**Solid fuels shall not be burned with this appliance.**

## SAFETY INFORMATION



### DANGER

#### EXPLOSION FIRE HAZARD

Keep solid combustibles, such as building materials, paper or cardboard, a safe distance away from the fire pit as recommended by the instructions.

Provide adequate clearances around air openings into the combustion chamber.

Never use the fire pit in spaces which do or may contain volatile or airborne combustibles, or products such as gasoline, solvents, paint thinner, dust particles or unknown chemicals. During operation, this product can be a source of ignition. Keep fire pit area clear and free from combustible materials, gasoline, paint thinner, cleaning solvents and other flammable vapors and liquids. Do not use fire pit in areas with high dust content. Minimum fire pit clearances from combustible materials: two (2) feet from the sides & two (2) feet from the rear, 6 feet from ceiling.



### DANGER

#### EXPLOSION FIRE HAZARD

Never store propane near high heat, open flames, pilot lights, direct sunlight, other ignition sources or where temperatures exceed 120 degrees F (49°C).

Propane vapors are heavier than air and can accumulate in low places. If you smell gas, leave the area immediately.

Never install or remove propane cylinder while fire pit is lighted, near flame, pilot lights, other ignition sources or while fire pit is hot to touch.

This fire pit is red hot during use and can ignite flammables too close to the burner. Keep flammables at least 2 feet from sides & 2 feet from rear, 6 feet from ceiling. Keep gasoline and other flammable liquids and vapors well away from fire pit.

Store the propane cylinder outdoors in a well ventilated space out of reach of children.

Never store the propane cylinder in an enclosed area (house, garage, etc.). If fire pit is to be stored indoors, disconnect the propane cylinder for outdoor storage.



### DANGER

#### CARBON MONOXIDE HAZARD

This fire pit is a combustion appliance. All combustion appliances produce carbon monoxide (CO) during the combustion process. This product is designed to produce extremely minute, non-hazardous amounts of CO if used and maintained in accordance with all warnings and instructions. Do not block air flow into or out of the fire pit.

Carbon monoxide (CO) poisoning produces flu-like symptoms, watery eyes, headaches, dizziness, fatigue and possibly death. You can't see it and you can't smell it. It's an invisible killer. If these symptoms are present during operation of this product get fresh air immediately!

For outdoor use only.

Never use inside house, or other unventilated or enclosed areas.

This fire pit consumes air (oxygen). Do not use in unventilated or enclosed areas to avoid endangering your life.



### WARNING

**WARNING** indicates an imminently hazardous situation which, if not avoided, will result in death or serious injury.



### WARNING

Improper installation, adjustment, alteration, service or maintenance can cause property damage, injury or death. Read the installation, operation and maintenance instructions thoroughly before installing or servicing this equipment.

## SAFETY INFORMATION



### WARNING

We cannot foresee every use which may be made of our fire pit.

Check with your local fire safety authority if you have questions about fire pit use.

Other standards govern the use of fuel gases and heat producing products for specific uses. Your local authorities can advise you about these.

If no local codes exist, follow National Fuel Gas Code, ANSI Z223.1. In Canada, installation must conform to local codes. If no local codes exist, follow the current National standards of CANADA CAN/CGA-B 149.2.



### WARNING

Certain materials or items, when stored under the fire pit, will be subjected to radiant heat and could be seriously damaged.



### WARNING

This product is fueled by propane gas. Propane gas is invisible, odor less, and flammable. An odorant is normally added to help detect leaks and can be described as a “rotten egg” smell. The odorant can fade over time so leaking gas is not always detectable by smell alone.

Propane gas is heavier than air and leaking propane will sink to the lowest level possible. It can ignite by ignition sources including matches, lighters, sparks or open flames of any kind many feet away from the original leak. Use only propane gas set up for vapor withdrawal.

Store or use propane gas in compliance with local ordinances and codes or with ANSI/NFPA 58. Turn off propane when not in use.



### WARNING

California Proposition 65

Combustion by-products produced when using this product contain chemicals known to the State of California to cause cancer, birth defects, and other reproductive harm.



### WARNING

**BURN HAZARD**

Never leave fire pit unattended when hot or in use. Keep out of reach of children.



### CAUTION

CAUTION indicates an imminently hazardous situation which, if not avoided, may result in minor or moderate personal injury, or property damage.



### CAUTION

**SERVICE SAFETY**

Keep all connections and fittings clean. Make sure propane cylinder valve outlet is clean. During set up, check all connections and fittings for leaks using soapy water. Never use a flame.

Use as a heating appliance only. Never alter in any way or use with any device.



### WARNING

Alert children and adults to the hazards of high surface temperatures. Stay away from these surfaces to avoid burning skin or igniting clothing.

Carefully supervise young children when in the vicinity of the fire pit.

Do not hang clothing or any other flammable materials from the fire pit, or place on or near the fire pit.

Replace any guard or protective device removed for servicing the appliance prior to placing back in service.

Installation and repair should be done by a qualified service person. The fire pit should be inspected before use and annually by a qualified service person. More frequent cleaning may be required as necessary. It is imperative that the control compartment, burners, and circulating air passageway of the appliance be kept clean.

# OPERATION CHECKLIST

---

## Operation Checklist

For a safe and pleasurable heating experience, perform this check before each use.

### Before Operating:

1. The max. inlet supply pressure: max. Gas supply 11 in w.c. (2.74kPa)
2. I am familiar with entire owner's manual and understand all precautions noted.
3. All components are properly assembled, intact and operable.
4. No alterations have been made.
5. All gas connections are secure and do not leak.
6. Wind velocity is below 10 mph.
7. Unit will operate at reduced efficiency below 40 degrees F/4.44 C.
8. Fire pit is outdoors (outside any enclosure).
9. There is adequate fresh air ventilation. Do not use this appliance if any part has been under water. Immediately call a qualified service technician to inspect the appliance and to replace any part of the control system and gas control which has been under water.
10. Fire pit is away from gasoline or other flammable liquids or vapors.
11. Fire pit is away from windows, air intake openings, sprinklers and other water sources.
12. Fire pit is at least 48 in. on rear and at least 48 in. on sides from combustible materials.
13. Fire pit is on a hard and level surface.
14. There are no signs of spider or insect nests.
15. All burner passages are clear.
16. All air circulation passages are clear.
17. *Children and adults should be alerted to the hazards of high surface temperatures and should stay away to avoid burns or clothing ignition.*
18. *Young children should be carefully supervised when they are in the area of the fire pit.*
19. *Clothing or other protective material should not be hung from the fire pit, or placed on or near the fire pit.*
20. *Any guard or other protective device removed for servicing the fire pit must be replaced prior to operating the fire pit.*
21. *Installation and repair should be done by a qualified service person. The fire pit should be inspected before use and at least annually by a qualified service person.*
22. *More frequent cleaning may be required as necessary. It is imperative that control compartment, burner and circulating air passageways of the fire pit be kept clean.*

### After Operation

1. Gas control is in OFF position.
2. Gas Tank valve is OFF.
3. Disconnect Gas line.
4. After each use, replace cap on tank.

## PREPARATION

---

Before beginning assembly of product, make sure all parts are present. Compare parts with package contents list and hardware contents above. If any part is missing or damaged, do not attempt to assemble the product. Contact customer service for replacement parts.

**Estimated Assembly Time: 60 minutes**

Tools Required Assembly (not included) : Leak Test Solution.

# ASSEMBLY

**NOTE: It is best to use TWO PEOPLE for assembly of this gas fire pit.**

1. Carefully unpack all items from the box. Place the base in the final position. There must be a minimum of 48 in / 122 cm of clearance from the side of the table top to any combustible walls.
2. Place the tabletop on the base. Secure the tabletop to the firepit base using the bolts and washers that are provided

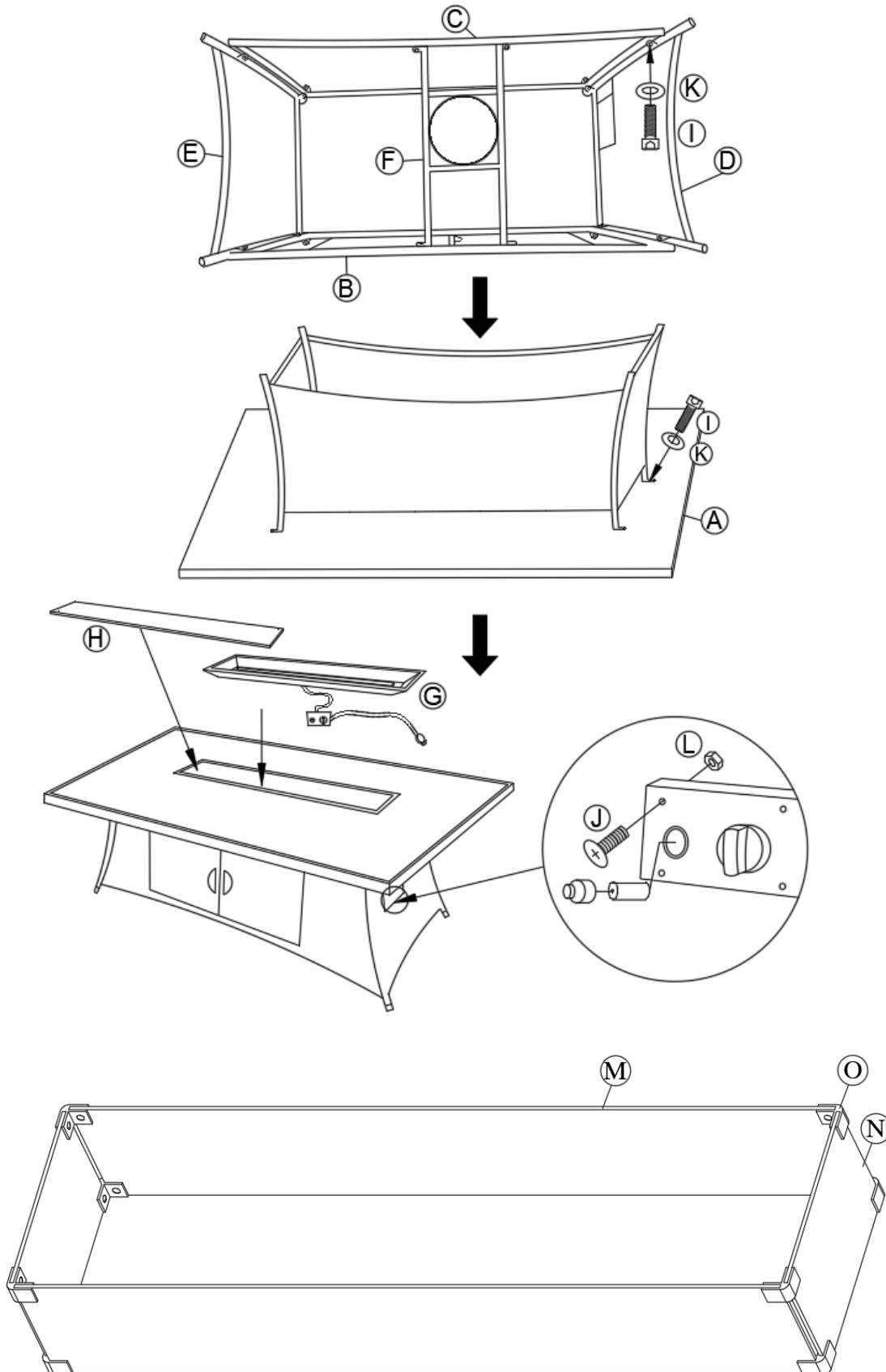

## ASSEMBLY

---

3. Pour the lava rock into the burner pan completely covering the burner.

4. Connect the hose and regulator to the cylinder. The propane gas and cylinder are sold separately. Use a standard 20 lb / 9.1kg. propane cylinder only. Use this fire pit only with a propane vapor withdrawal supply system. See Chapter 5 of the standard for storage and handling of liquefied petroleum gas, ANSI/NFPA 58. Your local library or fire department should have this book. Storage of an appliance indoors is permissible only if the cylinder is disconnected and removed from the appliance. A cylinder must be stored outdoors in a well-ventilated area out of reach of children. A disconnected cylinder must have dust caps tightly installed and must not be stored in a building, garage or any other enclosed area. The maximum inlet gas supply pressure: 250 psi..

The minimum hourly of 50000 Btu is required input rating for a fire pit at rating less than full input rating. The pressure regulator and hose assembly supplied with the appliance must be used. The installation must conform with local codes, or in the absence of local codes, with national fuel gas code, ANSI Z223.1/NFPA54, natural gas and propane Installation Code, CSA B149.1, or propane storage and handling code, B149.2.

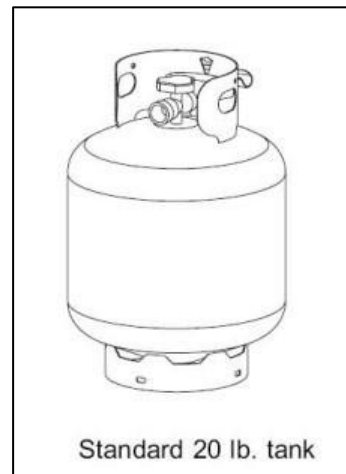

## ASSEMBLY

---

A dented, rusted or damaged propane cylinder may be hazardous and should be checked by your cylinder supplier. Never use a propane cylinder with a damaged valve connection.

The propane cylinder must be constructed and marked in accordance with the specifications for LP gas cylinders of the U.S. Department of Transportation (DOT) or the standard for cylinders, spheres and tubes for transportation of dangerous goods and commission

The cylinder must have a listed overfilling prevention device.

The LP gas tank must have a listed overfilling prevention device and a QCCI or Type I (CGA791) LP gas tank connection.

The cylinder must have a connection device compatible with the connection for the appliance.

The cylinder used must include a collar to protect the cylinder valve.

Never connect an unregulated propane cylinder to the appliance. Attach regulator to cylinder. Complete attachment. Install cylinder. Secure the propane cylinder with the cylinder screw by tightening the screw until it comes in contact with the cylinder.

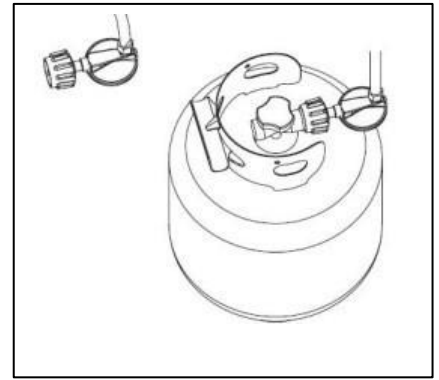

Do not store a spare LP-gas cylinder under or near this appliance;  
Never fill the cylinder beyond 80 percent full;  
Place the dust cap on the cylinder valve outlet whenever the cylinder is not in use. Only install the type of dust cap on the cylinder valve that is provided with the cylinder valve. Other type of caps or plugs may result in leakage of propane.

**ATTENTION:** THIS PRODUCT IS NOT FOR COMMERCIAL USE INTENDED FOR RESIDENTIAL USE ONLY.

***Do not sit or stand on this table.***

***Keep children away during assembly, as this item contains small parts which can be swallowed by children.***

***Do not use indoors or inside any enclosure.***

***Retain the assembly instructions for future reference. Installer – Please leave these instructions with the owner.***

***The burning trace of the fire system is because the fire test must be carried out before leaving the factory, which will not affect the use.***

## OPERATION INSTRUCTIONS

### Leak Test

#### WARNING

- Perform all leak tests outdoors.
- Extinguish all open flames.
- NEVER leak test when smoking.
- Do not use the fire pit until all connections have been leak tested and do not leak.

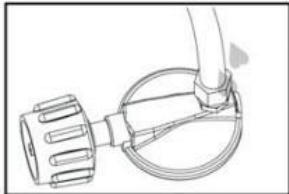

Hose / Regulator  
connection

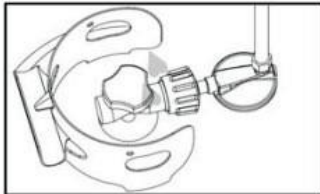

Regulator / Cylinder  
connection

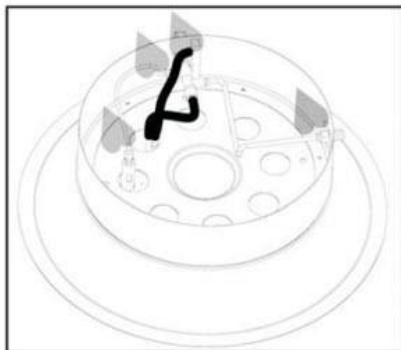

1. Make 2-3 oz. of leak test solution (one part liquid dishwashing detergent and three parts water).
2. Apply several drops of solution where hose attaches to regulator.
3. Apply several drops of solution where regulator connects to cylinder.
4. Make sure all fire pit and light valves are OFF.
5. Turn cylinder valve ON.

**If bubbles appear at any connection, there is a leak.**

1. Turn cylinder valve OFF.
2. If leak is at hose/regulator connection: tighten connection and perform another leak test. If bubbles continue appearing, the hose should be returned to the place of purchase.
3. If leak is at regulator/cylinder valve connection: disconnect, reconnect, and perform another leak check. If you continue to see bubbles after several attempts, cylinder valve is defective and should be returned to cylinder's place of purchase.

**If NO bubbles appear at any connection, the connections are secure.**

**NOTE:** Whenever gas connections are loosened or removed, you must perform a complete leak test. Complete installation.

# OPERATION INSTRUCTIONS



## DANGER

- CARBON MONOXIDE HAZARD
- For outdoor use only. Never use inside house, or other unventilated or enclosed areas. This fire pit consumes air (oxygen). Do not use in unventilated or enclosed areas to avoid endangering your life.



## WARNING

Very hot while in operation!  
Never lean over the fireplace while in use.  
Failure to comply with these instructions may result in serious bodily injury.

*Caution: Do not attempt to operate until you have read and understand all General Safety Information in this manual and all assembly is complete and leak checks have been performed.*

### Before Turning Gas Supply ON:

1. Your fire pit was designed and approved for outdoor use only. Do NOT use it inside a building, garage, or any other enclosed area.
2. Make sure surrounding areas are free of combustible materials, gasoline, and other flammable vapors or liquids.
3. Ensure that there is no obstruction to air ventilation. Be sure all gas connections are tight and there are no leaks.
4. Be sure the cylinder cover is clear of debris. Be sure any component removed during assembly or servicing is replaced and fastened prior to starting.

### Before Lighting:

1. Fire pit should be thoroughly inspected before each use, and by a qualified service person at least annually. If relighting a hot fire pit, always wait at least 5 minutes.
2. Inspect the hose assembly for evidence of excessive abrasion, cuts, or wear. Suspected areas should be leak tested. If the hose leaks, it must be replaced prior to operation. Only use the replacement hose assembly specified by manufacturer. The burner must be replaced prior to the appliance being put into operation if it is evident that the burner is damaged. The replacement burner should be specified by manufacturer.

### Lighting:

- 1) Turn the control knob to the "OFF" position (Figure a).
- 2) Fully open LP cylinder valve.

*Note: For initial start or after any cylinder change, hold Control Knob IN for 2 minutes to purge air from gas lines before proceeding.*

- 3) Press and hold electronic igniter button.
- 4) Push in gas control knob and turn counterclockwise to "IGNITE" (Figure b) to light the fire pit. If needed, keep depressing and turning control knob counterclockwise until the heater lights (You should hear a clicking sound).
- 5) After fire pit lights, release control knob. Push in and turn the control knob to the "HIGH", then release control knob. If you want a lower temperature, push in the control knob and turn counterclockwise to the "LOW" (Figure c).

*Note: If burner fails to remain lit, all valves should be closed and a waiting period of at least 5 minutes should pass before attempting to light.*

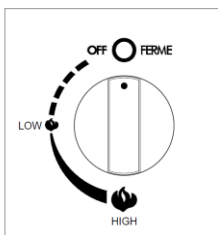

Figure a

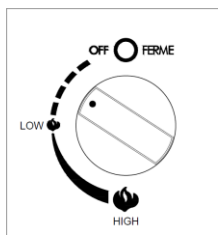

Figure b

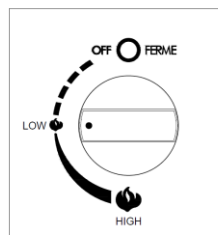
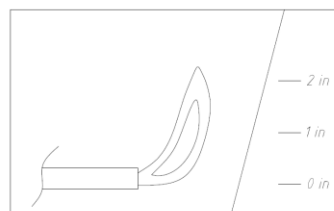
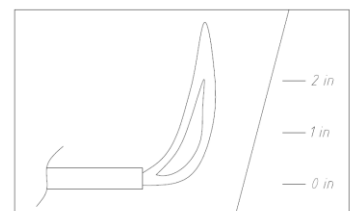

Figure c



Normal



Abnormal

## OPERATION INSTRUCTIONS

---



### WARNING

#### FOR YOUR SAFETY

Be careful when attempting to manually ignite this fire pit.  
Holding in the control knob for more than 10 seconds  
before igniting the gas will cause a ball of flame upon ignition.

#### When fire pit is ON:

Burner will display tongues of blue and yellow flame. These flames should not be yellow or produce thick black smoke, which would indicate an obstruction of airflow through the burners. The flame should be blue with straight yellow tops. If excessive yellow flame is detected, turn off heater and consult "Troubleshooting" on page 13.

#### Re-lighting:

1. Turn control knob to OFF.
2. Repeat the "Lighting" steps on prior page.



### WARNING

#### FOR YOUR SAFETY

Fire pit will be hot after use. Handle with extreme care.

#### Shut Down:

1. To extinguish burner depress control knob and continue to turn it clockwise to OFF.
2. Turn cylinder valve clockwise to OFF and disconnect regulator when heater is not in use.

## CARE AND MAINTENANCE

---



### WARNING

**FOR YOUR SAFETY:**

Do NOT touch or move fire pit for at least 45 minutes after use.

Borner is hot to the touch.

Allow borner to cool before touching.

To enjoy years of outstanding performance from your fire pit, make sure you perform the following maintenance activities on a regular basis:

Keep exterior surfaces clean.

1. Use warm soapy water for cleaning. Never use flammable or corrosive cleaning agents.
2. While cleaning your unit, be sure to keep the area around the burner dry at all times. Do not submerge the control valve assembly. If the gas control is submerged in water, do NOT use it. It must be replaced.
  - a. Keep the appliance area clear and free from combustible materials, gasoline and other flammable vapors and liquids.
  - b. Do not obstruct the flow of combustion and ventilation air.
  - c. Keep the ventilation opening(s) of the cylinder enclosure free and clear from debris.
3. Air flow must be unobstructed. Keep controls, burner, and circulating air passageways clean. Signs of possible blockage include.

## CARE AND MAINTENANCE

---

- Gas odor with extreme yellow tipping of flame. Fire pit does NOT reach the desired temperature. Fire pit glow is excessively uneven.
- Fire pit makes popping noises.
- Spiders and insects can nest in burner or orifices. This dangerous condition can damage fire pit and render it unsafe for use. Clean burner holes by using a heavy-duty pipe cleaner. Compressed air may help clear away smaller particles.
- Carbon deposits may create a fire hazard. Clean burner with warm soapy water if any carbon deposits develop.

Note: In a salt-air environment (such as near an ocean), corrosion occurs more quickly than normal. Frequently check for corroded areas and repair them promptly.

**TIP:**

Use high-quality automobile wax to help maintain the appearance of your fire pit. Apply to exterior surfaces only. Do not apply to burner..

### Storage

Between uses:

- Turn Control Knob OFF.
- Disconnect LP source.
- Store fire pit upright in an area sheltered from direct contact with inclement weather (such as rain, sleet, hail, snow, dust and debris).
- If desired, cover fire pit to protect exterior surfaces and to help prevent build-up in air passages.

**Note:** Wait until fire pit is cool before covering.

### ***During periods of extended inactivity or when transporting:***

- Turn Control Knob OFF.
- Disconnect LP source and move to a secure, well-ventilated location outdoors.
- Store fire pit upright in an area sheltered from direct contact with inclement weather (such as rain, sleet, hail, snow, dust and debris).
- If desired, cover fire pit to protect exterior surfaces and to help prevent build-up in air passages. Never leave LP cylinder exposed to direct sunlight or excessive heat.

**Note:** Wait until fire pit is cool before covering.

### Service

Only a qualified service person should repair gas passages and associated components.

**Caution:** Always allow firepit to cool before attempting service.

## TROUBLESHOOTING

---

PROBLEM	CAUSE	REMEDY
Burner won't light	No Propane Gas at Burner	Check that gas tank valve is open. Turn control knob to "ON" and push control knob in. Make sure tank has propane gas.
	No Spark at Electrode	Check that AAA battery is installed with negative (-) end first and has a charge. Check that the wire is connected to the ignition module. Check that the electrode is not cracked or broken.
	Lack of oxygen	Remove excess lava rocks or fire ices from around the ignition well.
Burner won't stay lit after lighting	Thermocouple not in flame	Check that the tip of the thermocouple is even with the top of the ignition well. Remove any fire ice from the ignition well.
	Thermocouple connection at the main control valve is loose	Tighten the thermocouple nut at the back of the valve.
	No Fire Ice on Burner	Cover the burner with fire ice per the instructions

## **1 YEAR LIMITED WARRANTY – Customers in the Continental US**

All components are warranted for a period of 1 year after date of purchase by the original owner against defects in materials and workmanship under normal use. This warranty does NOT cover normal wear and weathering, assembly and/or maintenance OR use in a commercial application if model is not designated as a commercial model.

This warranty is extended only to the original purchaser. Proof of purchase will be required before warranty service is rendered. The sales receipt is the only valid proof of purchase. This warranty only covers failures due to defects in materials or workmanship which occur during normal use. Failures and/or damage which result from accident, negligence, misuse, abuse, neglect, mishandling, alteration or modification, failure to maintain, improper assembly or maintenance, service by unauthorized agency or use of unauthorized components or damage that is attributable to acts of God are NOT covered.

**\*\*\*THERE ARE NO EXPRESS WARRANTIES EXCEPT AS LISTED ABOVE\*\*\***

**\*\*\*PURCHASER ASSUMES ALL RISKS IN THE ASSEMBLY AND OPERATION OF THIS UNIT\*\*\***

**\*\*\*FAILURE TO FOLLOW WARNINGS AND OPERATIONAL INSTRUCTIONS CONTAINED IN THIS MANUAL CAN RESULT IN SEVERE PROPERTY DAMAGE AND/OR PERSONAL INJURY\*\*\***

**SOME JURISDICTIONS DO NOT ALLOW THE EXCLUSION OR LIMITATION OF INCIDENTAL OR CONSEQUENTIAL DAMAGES, SO THE ABOVE LIMITATION OR EXCLUSION MAY NOT APPLY TO THE PURCHASER.**

This limited warranty gives you specific legal rights and you may also have other rights which vary from jurisdiction to jurisdiction. The provisions of the United Nations Convention on Contracts for the Sales of Goods shall not apply to this limited warranty or the sale of products covered by this limited warranty.