

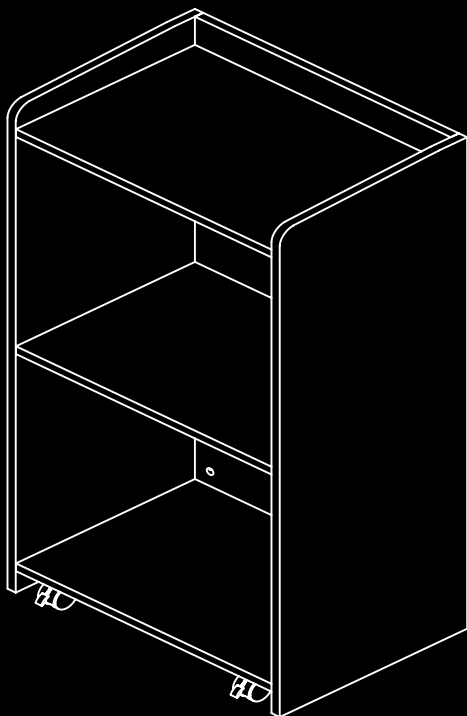

HOSTESS STAND WITH WHEELS



ADI661-07-SERIES

USER GUIDE



THANK YOU FOR YOUR PURCHASE.

Known in the industry for excellent products, Alpine Industries is a manufacturer of innovative, solution-based products for the commercial and institutional markets worldwide.

Combining commitment to the customer, design innovation and skilled, dedicated workforces, they have produced a range of products that are an essential part of every commercial facility.

Every product is designed to the highest standards, enabling you to get your requirements done in a reliable and cost-effective way.



Table of Contents

- 1** Parts
- 2** Hardware
- 4** Installation
- 9** Plastic Feet Instead of Wheels
- 10** Warranty

Parts

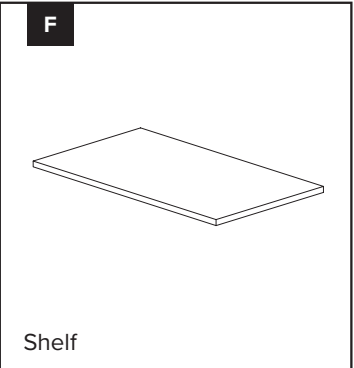
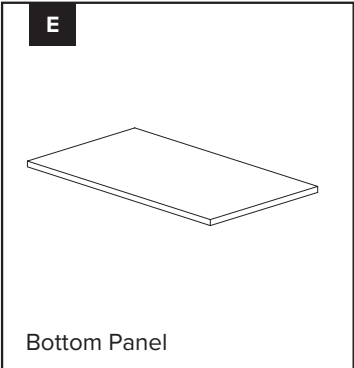
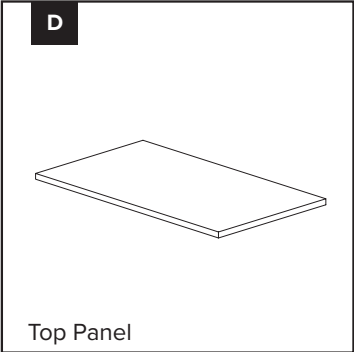
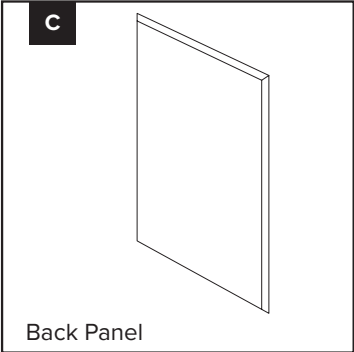
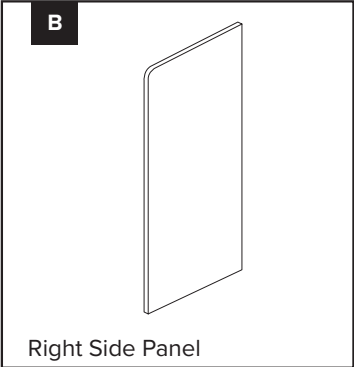
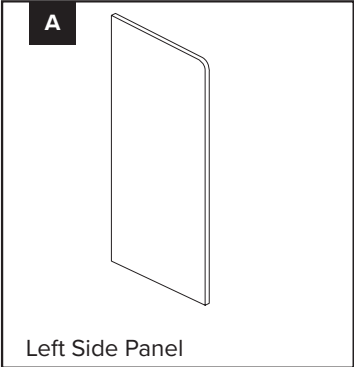

Hardware

1



Cam Lock (x 18)

2

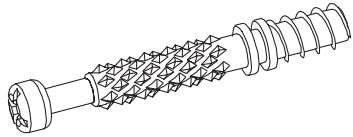

Cam Lock Bolt (x18)

3

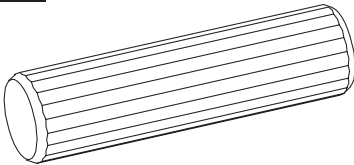

Wooden Dowel (x20)

4

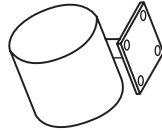

Caster Wheel (x4)

5

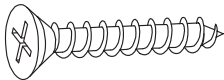

Screw 12mm (x16)

6

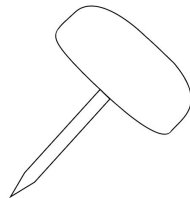

Plastic Feet (x4)

Tools Needed (But Not Included):

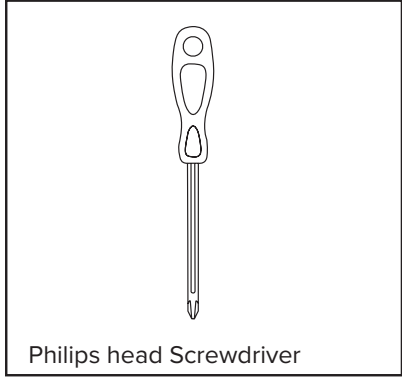
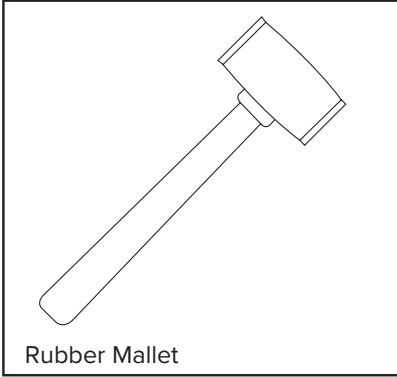

Installation

Step 1:

- A. Locate the Right Side Panel (B) and the Left Side Panel (A), lay it on a flat surface, and insert 10 Wooden Dowels (3) into the holes pictured.
- B. Gently tap them in until secure, with a rubber mallet.
- C. Insert 8 Cam Lock Bolt's (2) into the remaining pre-drilled holes.
- D. Screw them in until secure using a Philips head screwdriver.

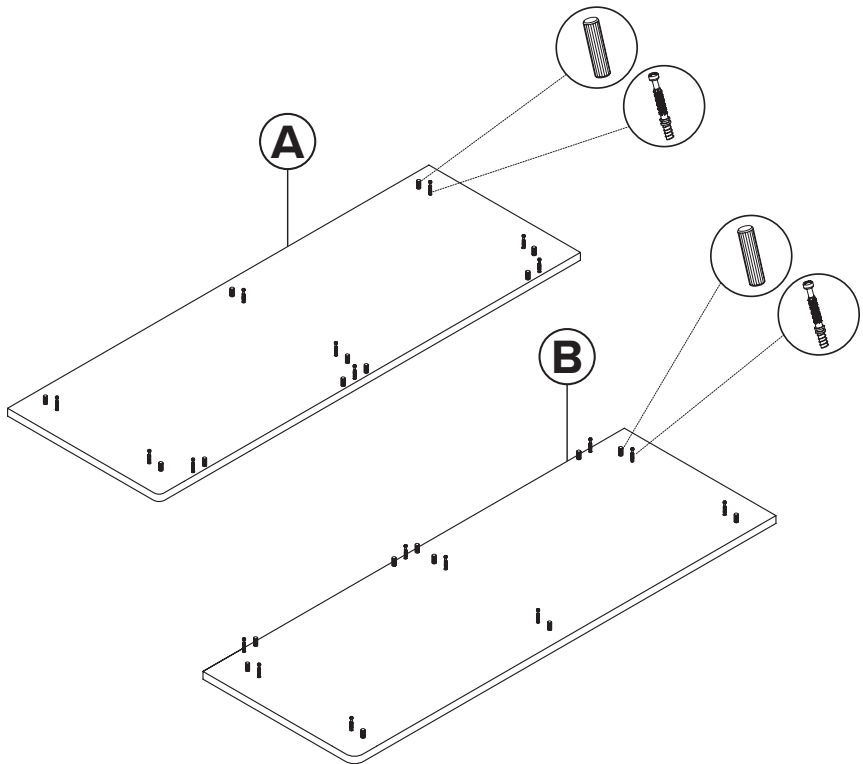

Step 2:

- A. Locate the Back Panel (C) and attach it to the Left Side Panel (A), as shown.
- B. Insert 3 Cam Locks (1) into the Back Panel (C) and turn to secure the Cam Lock Bolt (2) to the Back Panel (C).
- C. Locate the Top Panel (D), Bottom Panel (E), and Shelf (F).
 - a. On the panels, you will see four larger pre-drilled holes; this indicates the bottom of each one.
 - b. Make sure they're all facing the same way.
 - c. The Bottom Panel (E) will have the four larger holes as mentioned and 16 tiny holes, which will be used to install the Caster Wheels (4).
- D. Attach the three panels to the Left Side Panel (A) and gently tap them until they're flush.

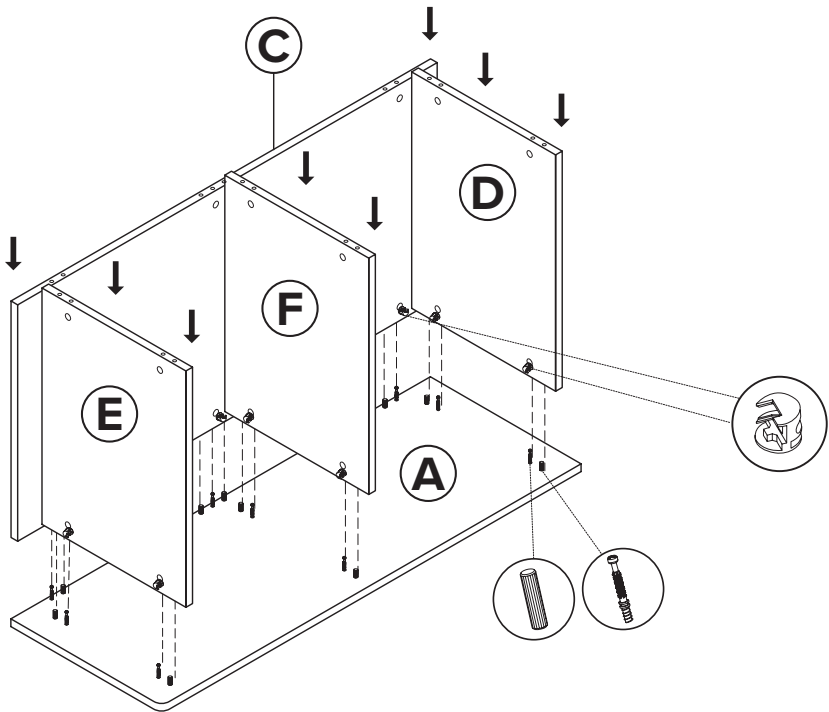

Step 3:

- A. Add the Cam Locks (1) to the left side of the three panels you just installed and secure them with a Philips head screwdriver.
- B. Attach the Right Side Panel (B) to the assembled structure you just made.
 - a. Gently tap the panel with a rubber mallet until flush with the assembled structure.

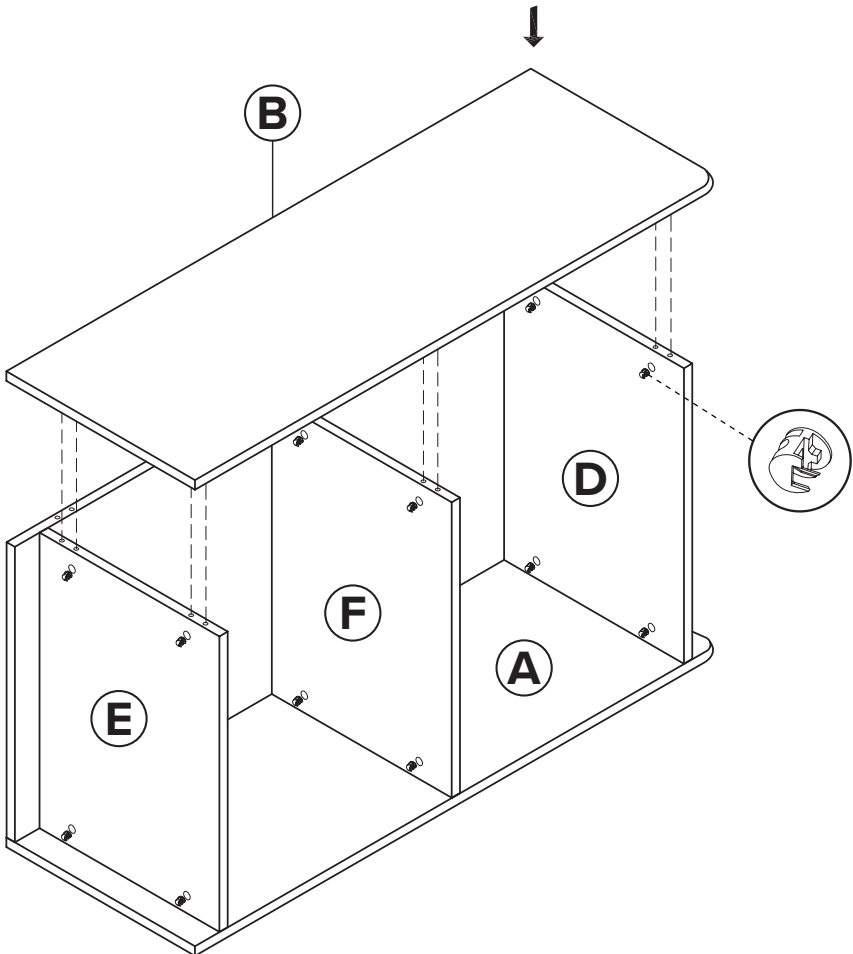

Step 4:

A. Add the remaining Cam Locks (1) to the Top Panel (D), Bottom Panel (E), and the Shelf (F).

B. Secure them with a Philips head screwdriver.

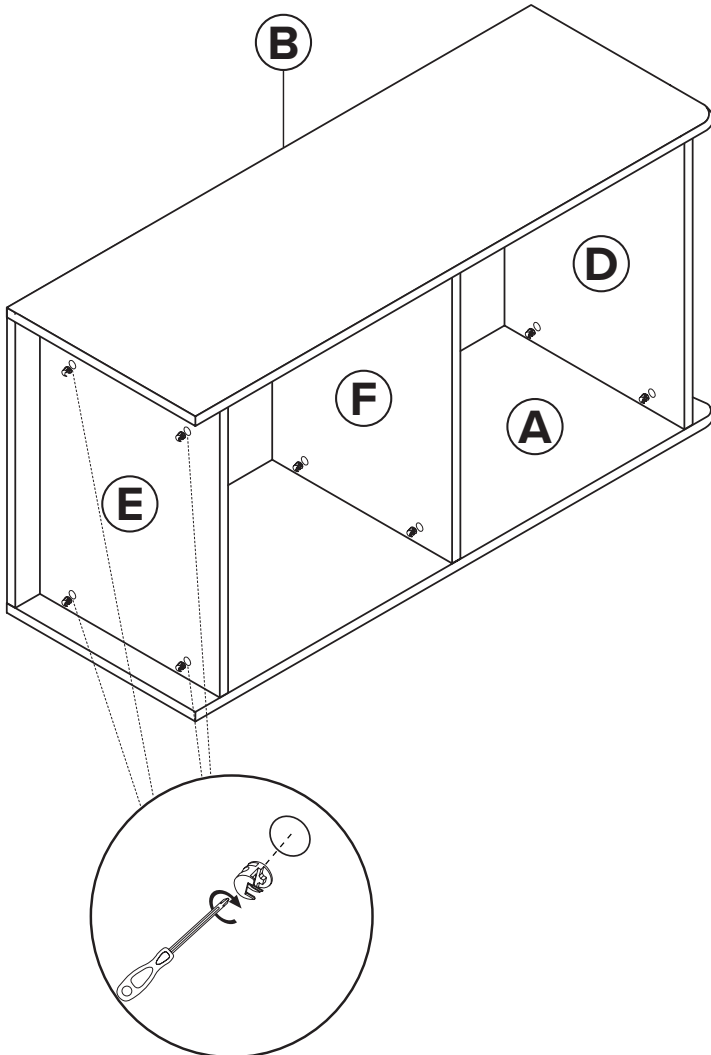

Step 5:

- A. Locate the bottom of you assembled structure, your 4 Caster Wheels (4), and 16 Screws (5).
- B. Line up the plate on the Caster Wheels (4) with the four holes and screw in 4 Screws (5) with a Philips head screwdriver until the screw head is flush with the wheel's plate.
- a. Make sure you put both locking Caster Wheels (4) in the front or in the back of the stand, depending on preference.
- C. Repeat this step for the three remaining wheels, and your Hostess Stand with Wheels is ready to be used.

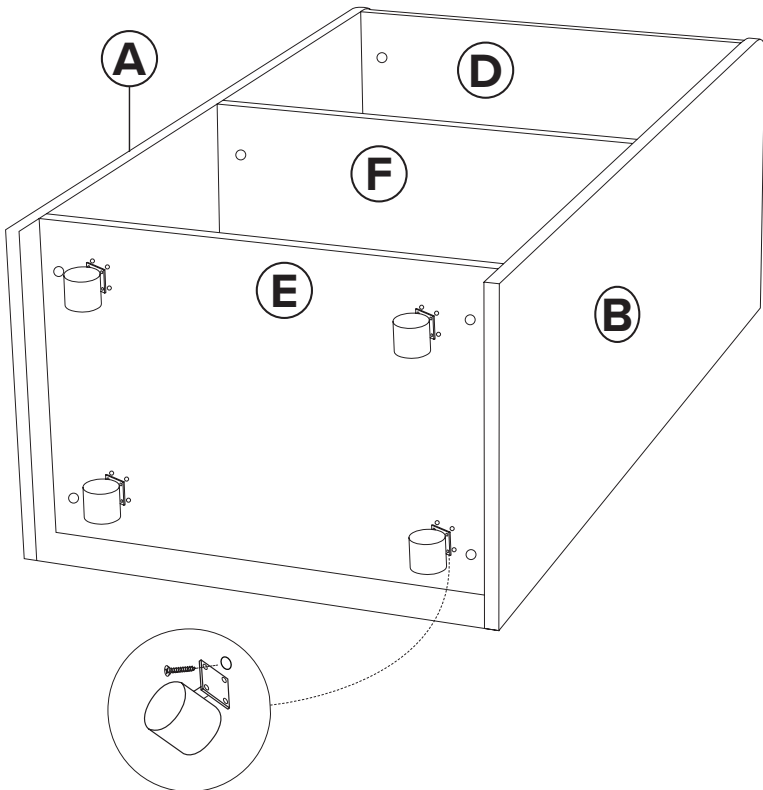

Plastic Feet Instead of Wheels:

- A. If you want to install the included Plastic Feet (6) on your Hostess Stand, first, lower it onto its Back Panel (C).
- B. Take your Plastic Feet (6) and gently tap them into the four corners of the Hostess Stand with a rubber mallet until secure.

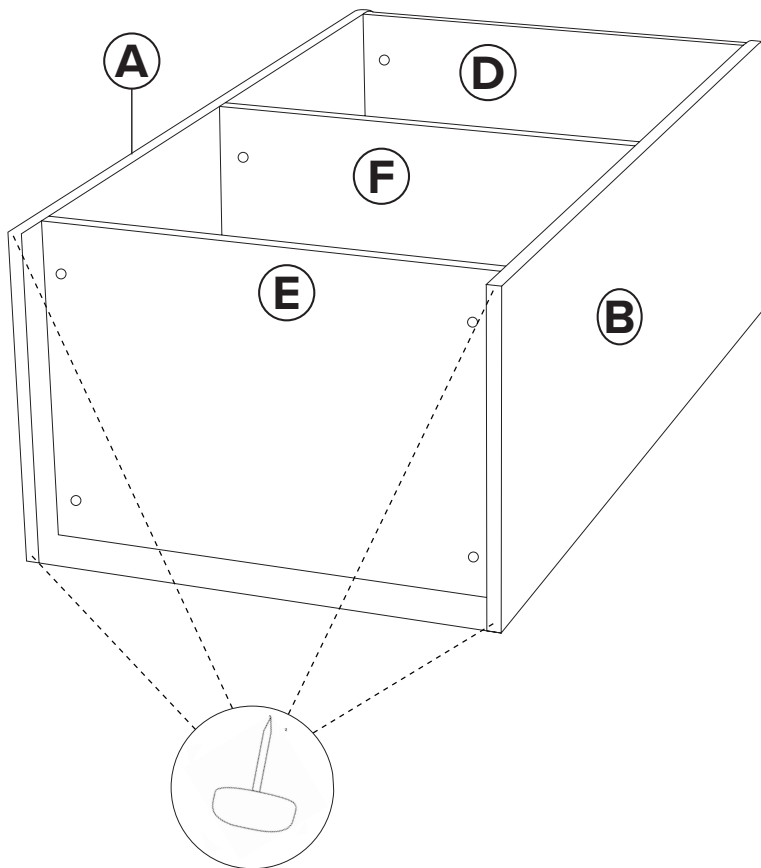

Limited Warranty

1. Adir Corp (the “Company” or “Tiger Companies”) warrants to the purchaser that the product will be free from defects in workmanship and materials for a period of 1 year from the date of purchase. The warranty period is not extended if we repair, replace, exchange, or provide a
2. These warranties are not assignable or transferable to any other person, including, without limitation, any subsequent owner or other transferee of the product.
3. This Warranty does not apply to: (a) damage caused by misuse, tampering, abuse, neglect, or accident; (b) damage caused by improper installation, modification, or service; (c) alteration of the serial number; or (d) use that violates the instructions furnished by the Company will void this warranty.
4. The sole responsibility of the Company shall be limited to (a) the repair or replacement (in its sole discretion) of any component of the product which fails to conform to this; (b) a refund the purchase price of such product (in its sole discretion), at no cost to the purchaser for the period of the warranty, or (c) an exchange for a similar product, comparable in function and price.
5. Contact the Company directly at 1-(800)-805-1790 to obtain service under this warranty. If it becomes applicable to send a defective product to the Company, a Return Authorization Number must first be obtained from the Company. In order to obtain service under this warranty, purchaser may be required to provide the Company with the following items (a) proof of purchase , (b) photographs and or videos (of the damage, and (c) a written testimonial describing the defect.
6. Products shipped without prior Return Authorization and Return Authorization Number may not be accepted, and the Company will not be responsible for their disposition and/or cost of return to the owner.
7. The Company will not assume any responsibility for any loss or damage incurred in shipping and or delivery.
8. The product(s) must be returned within 14 calendar days of receiving the return authorization from the Company and must include the original proof of purchase for the warranty to be honored.
9. Any implied warranties that the purchaser may have are limited to the duration of the warranties described above. There are no further warranties that extend or apply beyond the face hereof, and the Company expressly disclaims and excludes any and all warranties of merchantability or fitness for a particular purpose. Some states do not allow limitations on how long an implied warranty lasts, so the above limitation may not apply to you.
10. THE REMEDIES DESCRIBED ABOVE ARE YOUR SOLE AND EXCLUSIVE REMEDIES AND THE COMPANY’S ENTIRE LIABILITY FOR ANY BREACH OF THIS LIMITED WARRANTY. OUR LIABILITY SHALL UNDER NO CIRCUMSTANCES EXCEED THE ACTUAL AMOUNT PAID BY YOU FOR THE DEFECTIVE PRODUCT, NOR SHALL WE UNDER ANY CIRCUMSTANCES BE LIABLE FOR ANY CONSEQUENTIAL, INCIDENTAL, SPECIAL OR PUNITIVE DAMAGES OR LOSSES, WHETHER DIRECT OR INDIRECT. SOME STATES DO NOT ALLOW THE EXCLUSION OR LIMITATIONS OF INCIDENTAL OR CONSEQUENTIAL DAMAGES, SO THE LIMITATION MAY NOT APPLY TO YOU.
11. This warranty gives you specific legal rights, and you may also have additional rights which vary from state to state.



ITEM#: ADI661-07-SERIES

© 2022 Adir Corp

adircorp.com