

Installation & Assembly

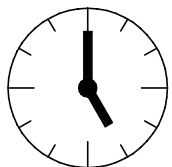

0,5h

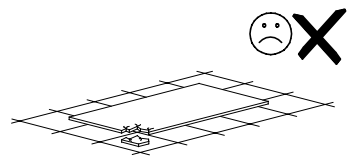

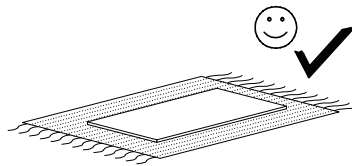
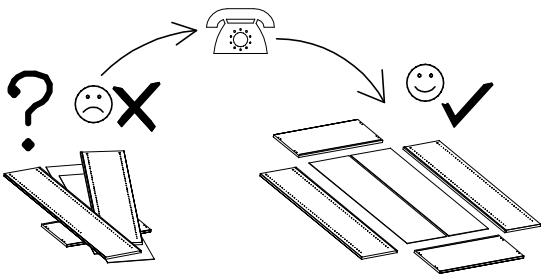
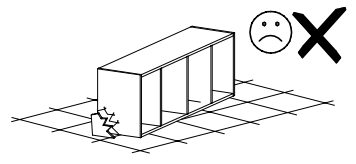
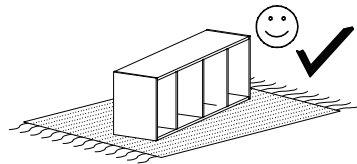
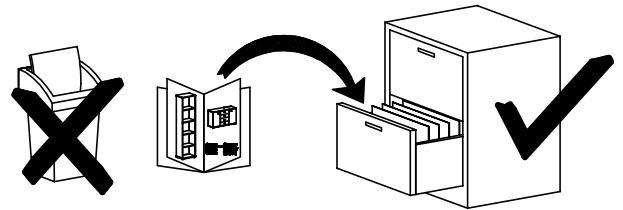
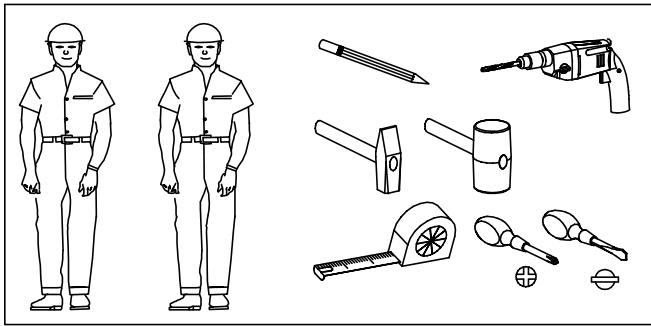
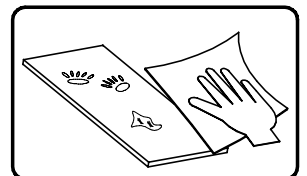
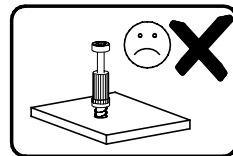
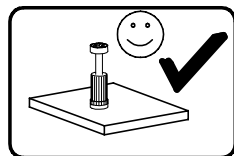
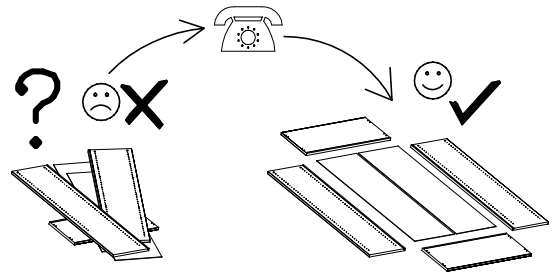
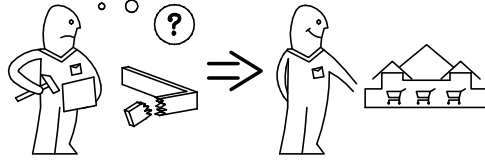
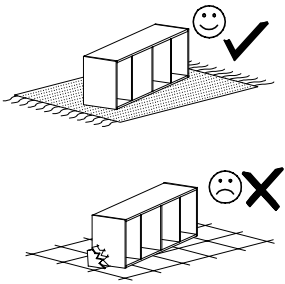

nr	L[mm]	B[mm]	T[mm]	Menge	Colli
1	920	770	19	1	1/2

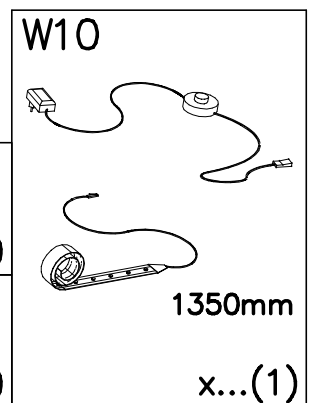
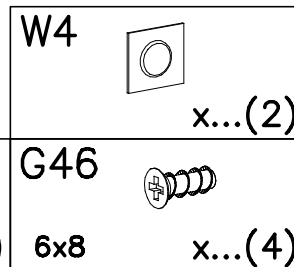
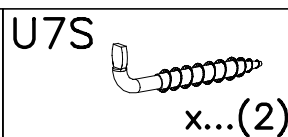
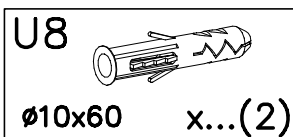
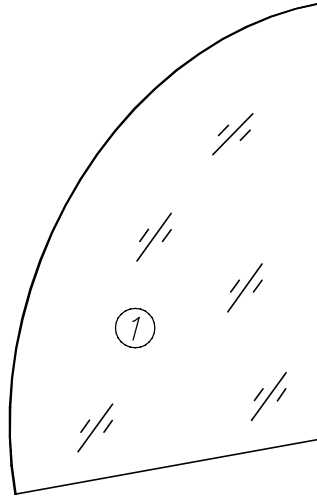



I



G46



6x8

x...(4)

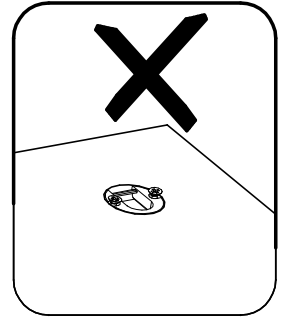
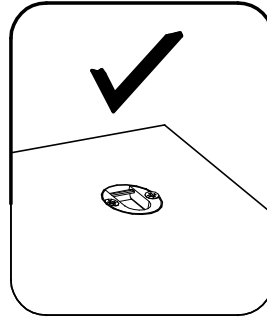
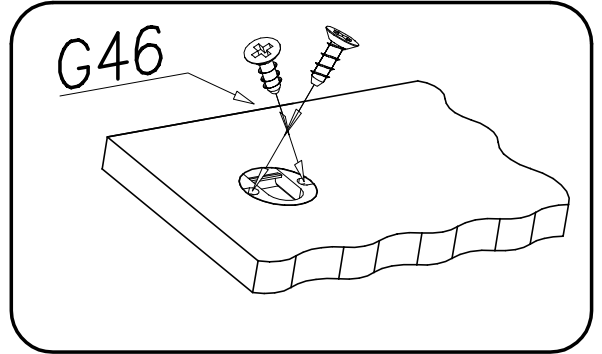
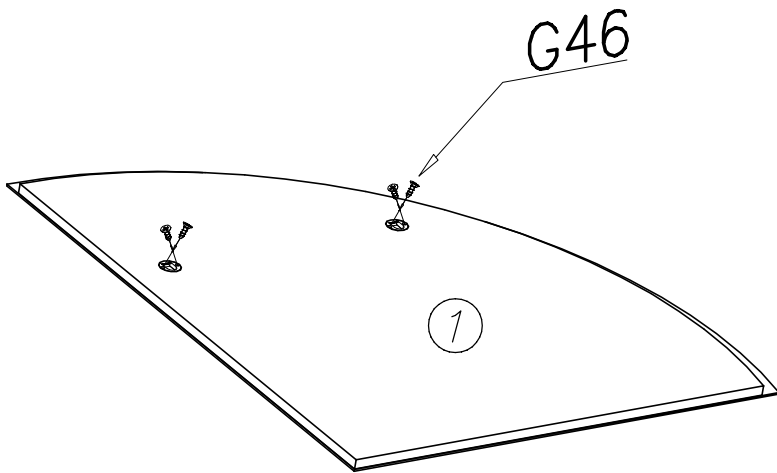

II

W4



2x

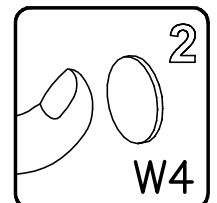
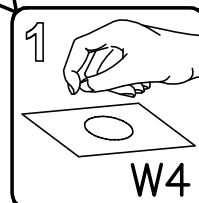
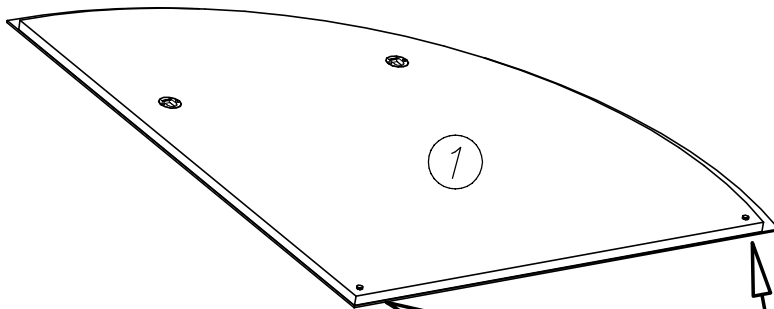



III

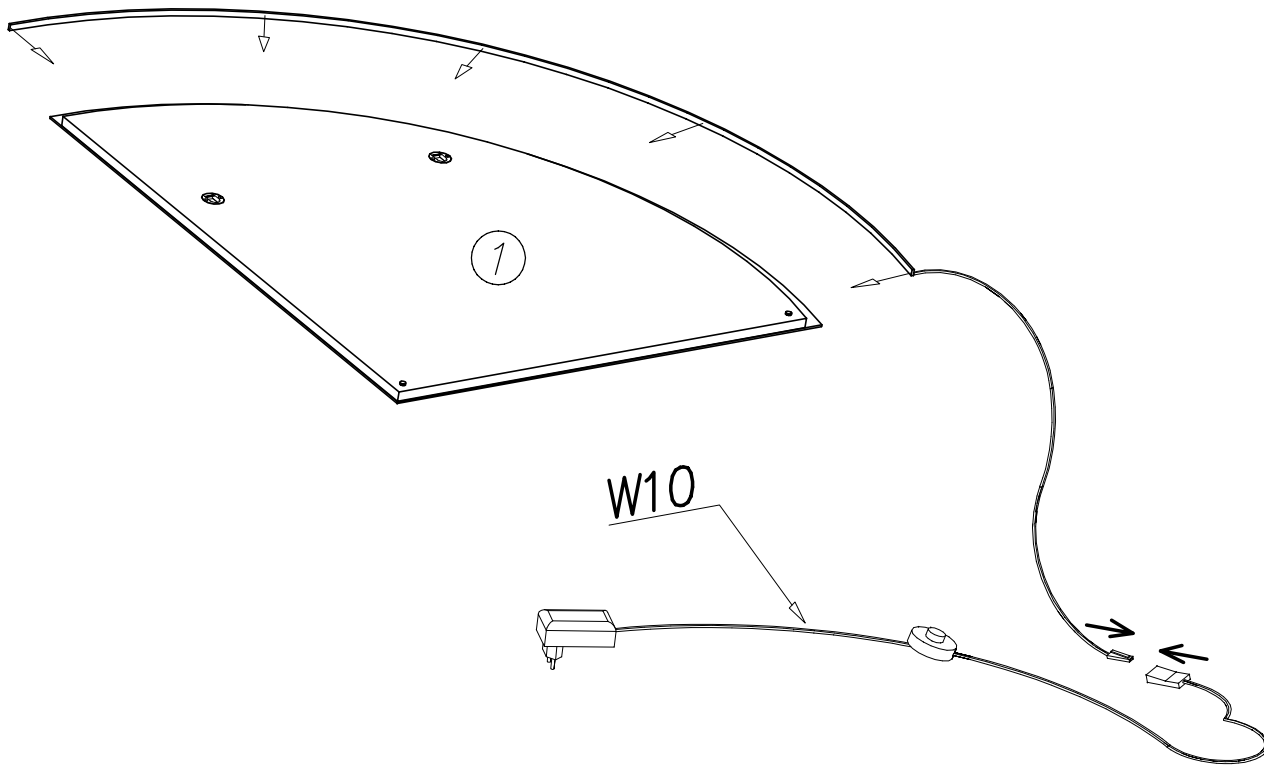
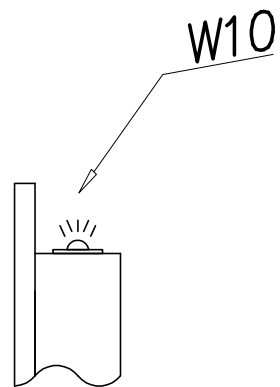
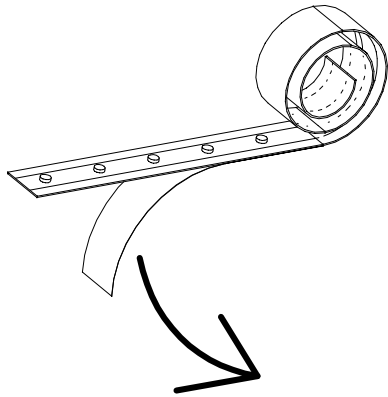



IV

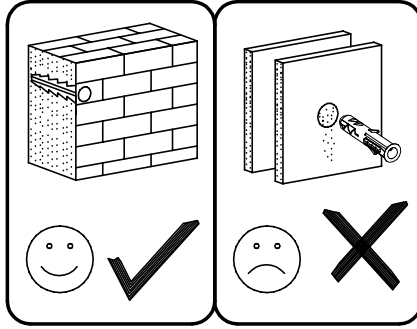

1

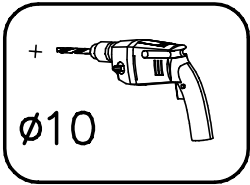

2

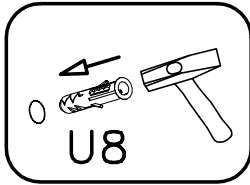

3

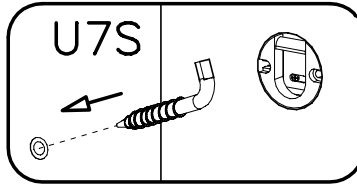

4

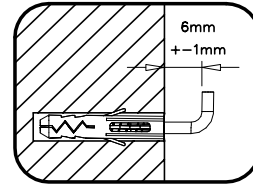

5

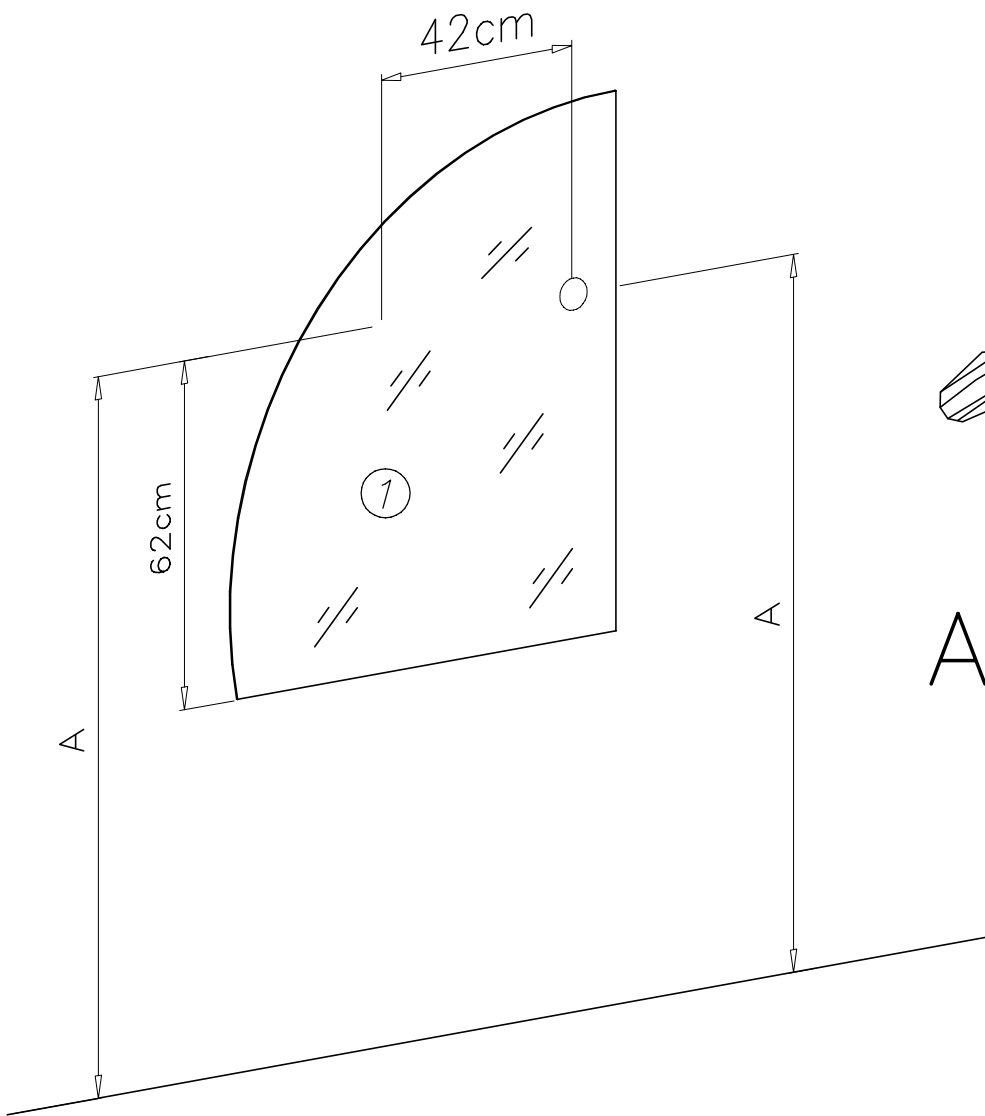
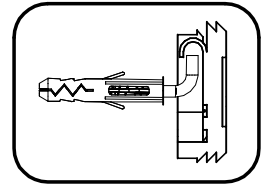

A = A

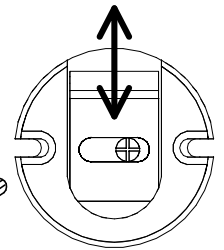

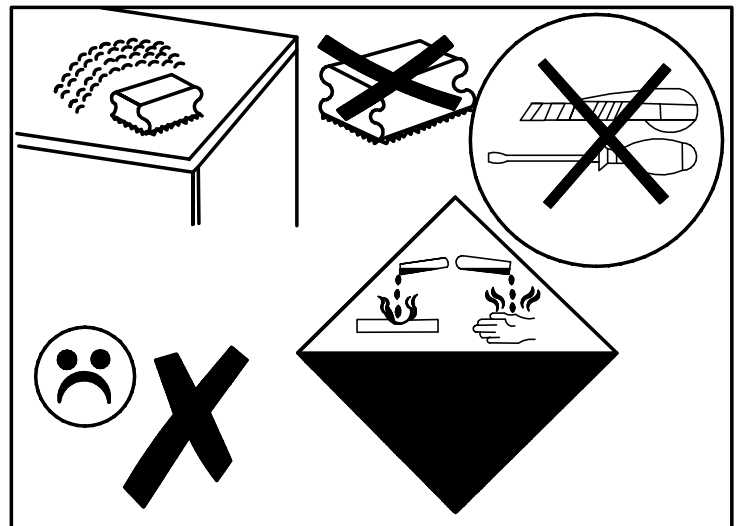
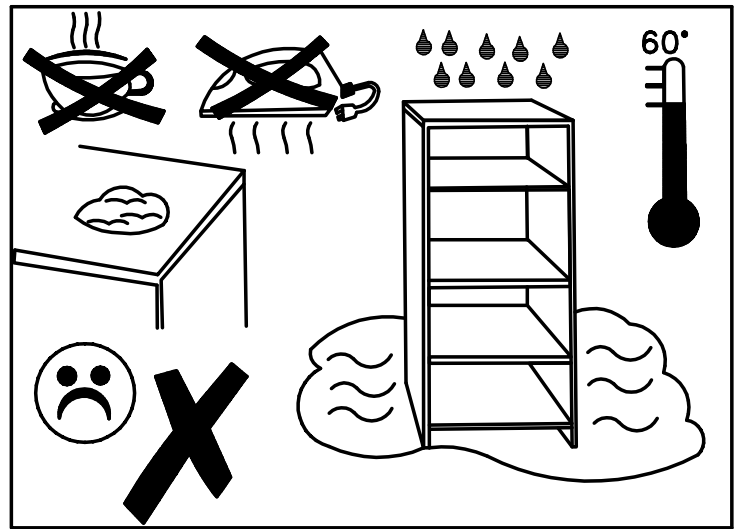
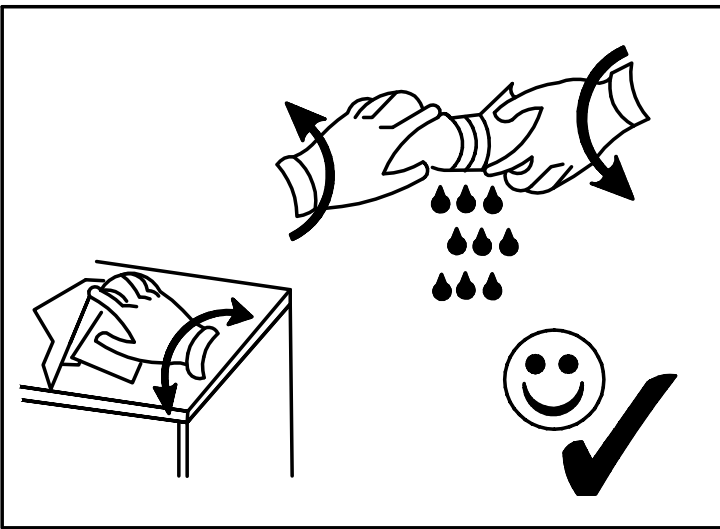
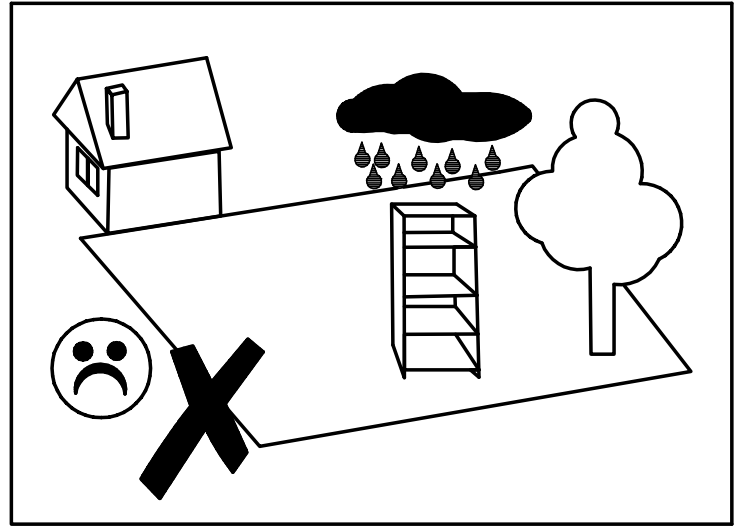
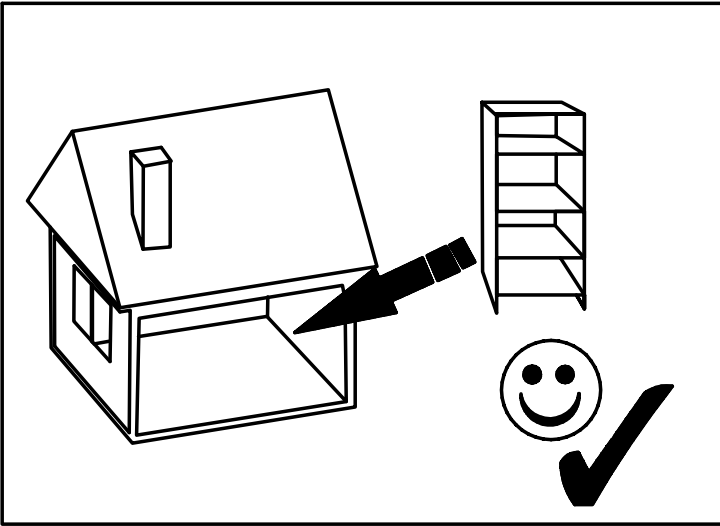

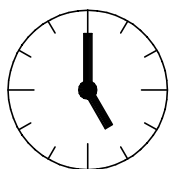
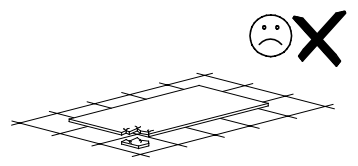
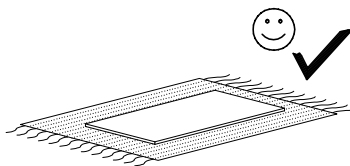
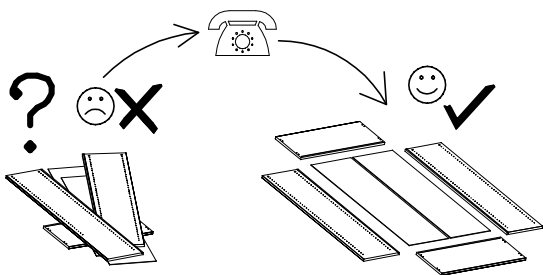
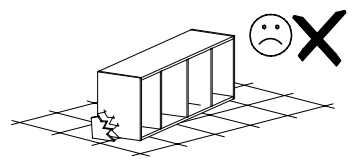
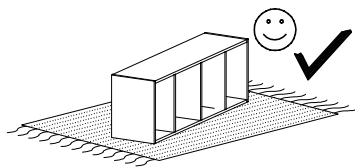
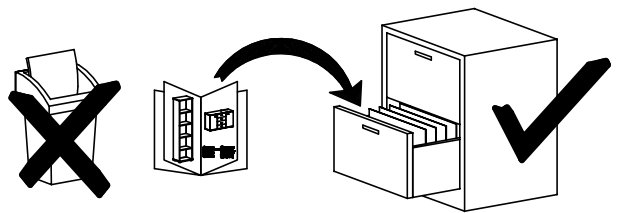
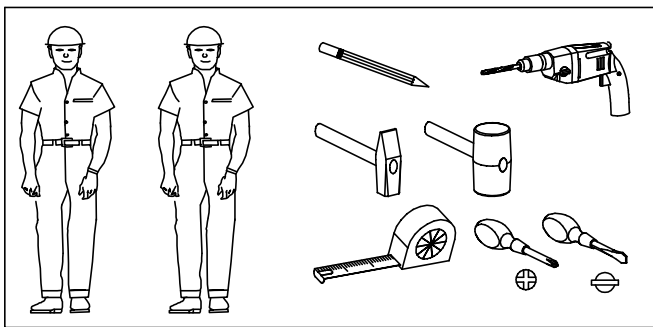
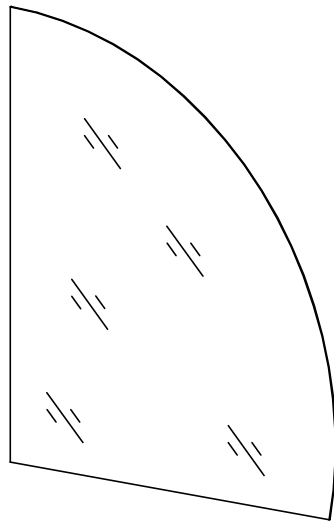

0,5h

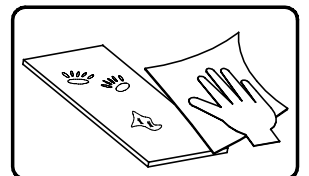
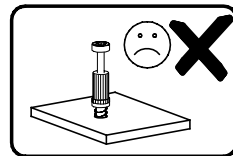
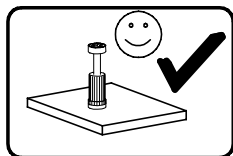

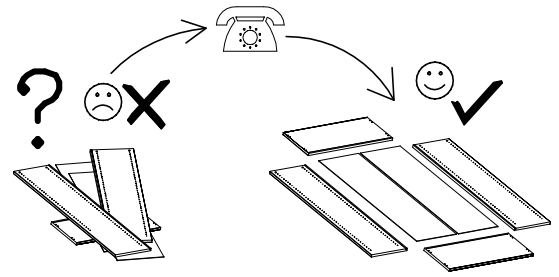
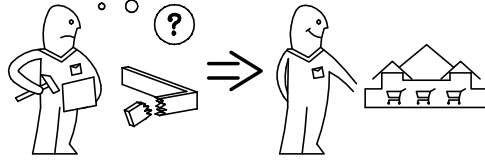
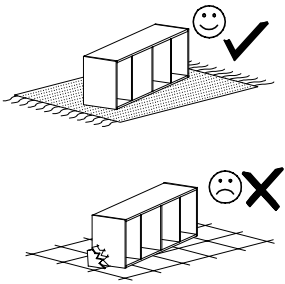

nr	L[mm]	B[mm]	T[mm]	Menge	Colli
1	920	770	19	1	1/2

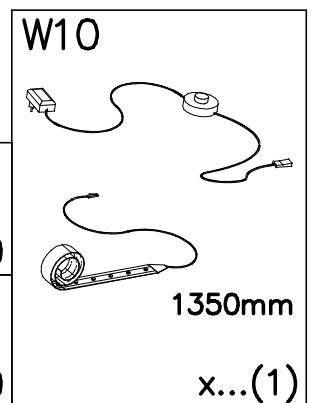
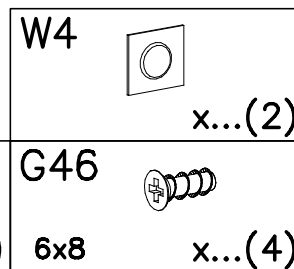
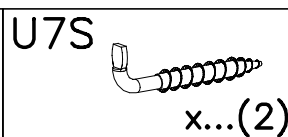
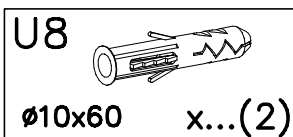
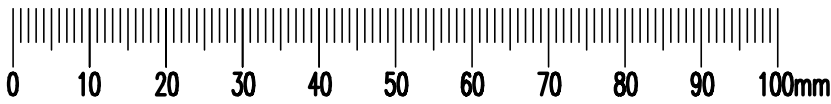
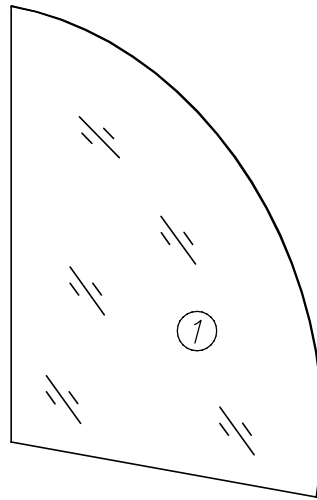



I



G46



6x8

x...(4)

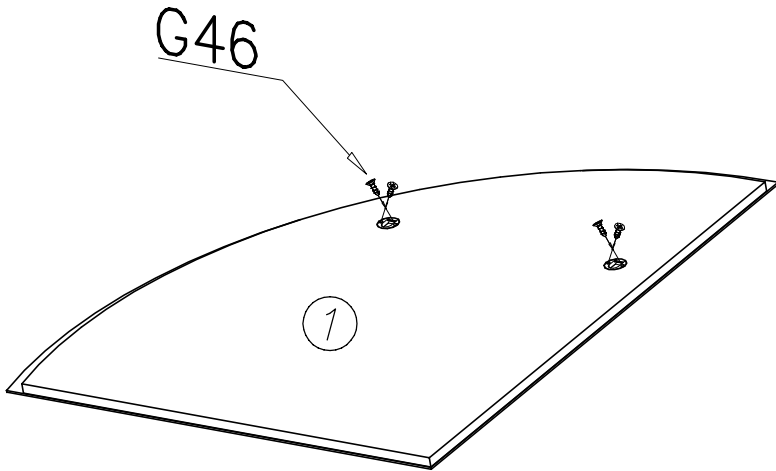
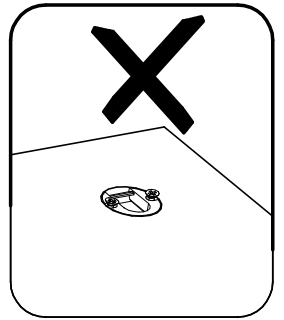
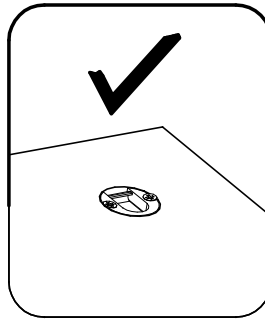
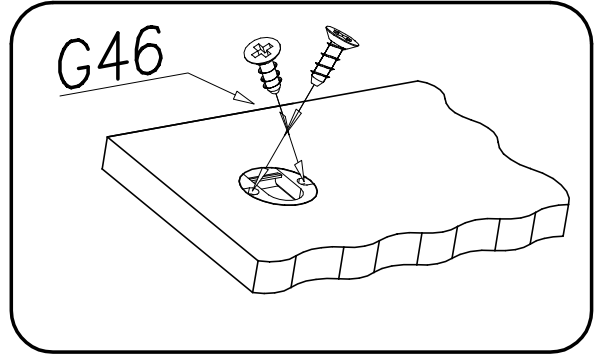

II

W4



2x

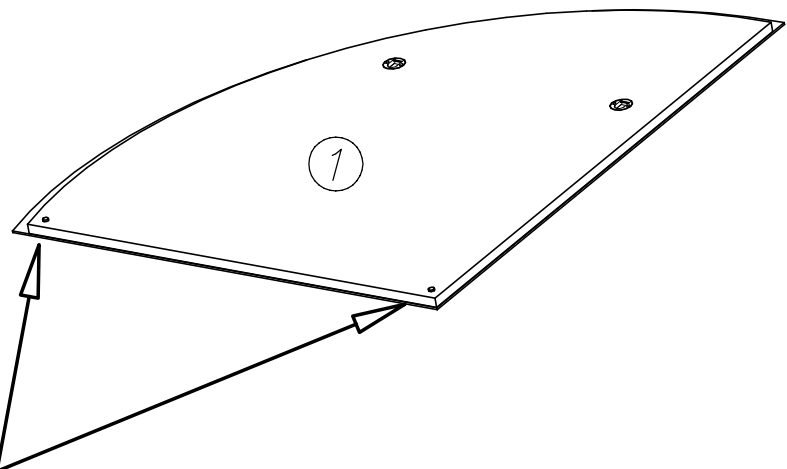
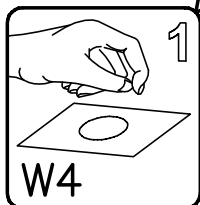
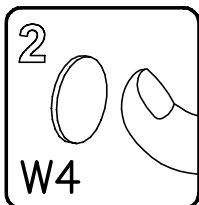



III

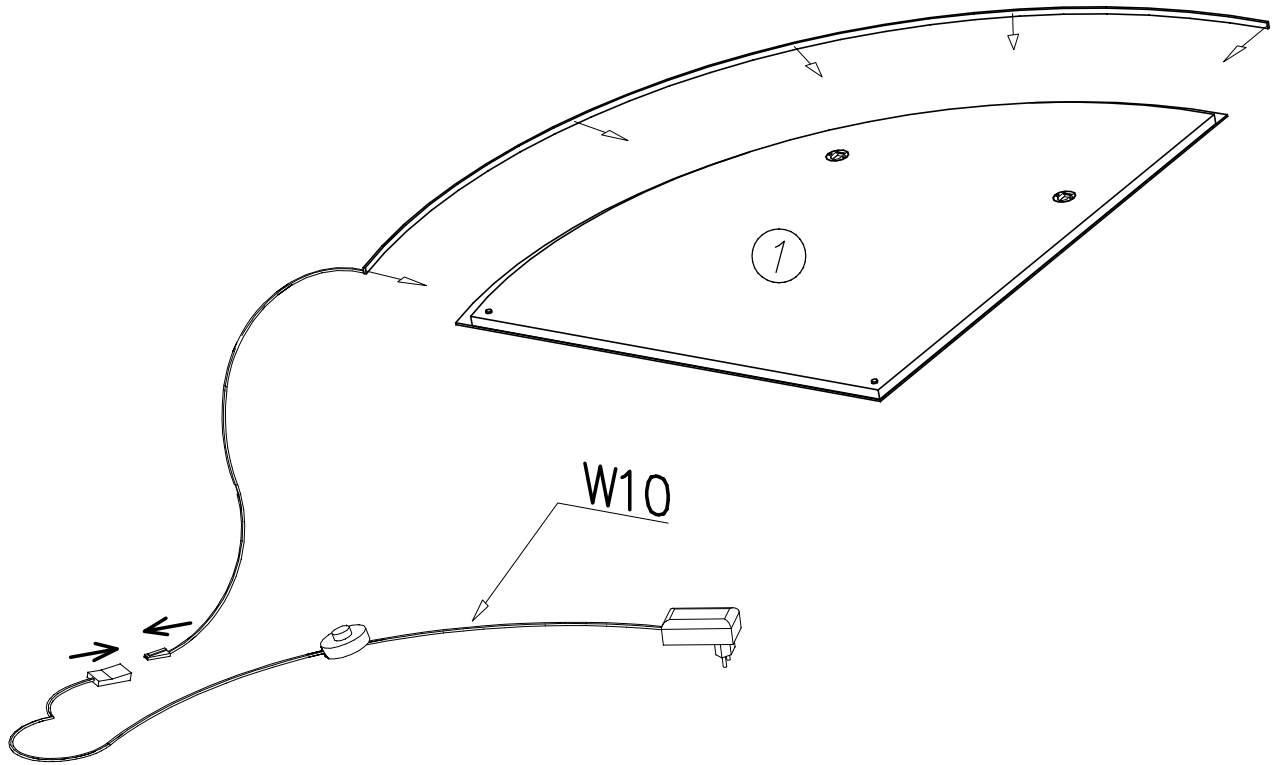
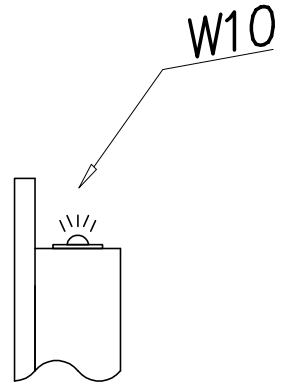
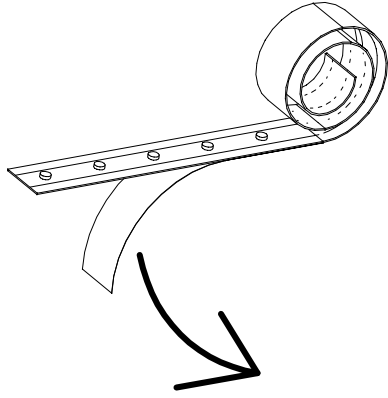



IV

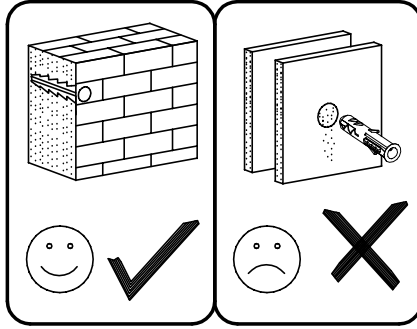

1

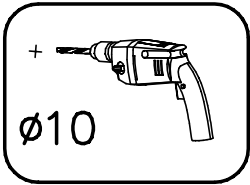

2

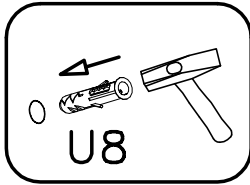

3

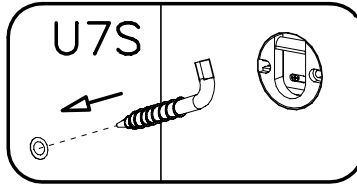

4

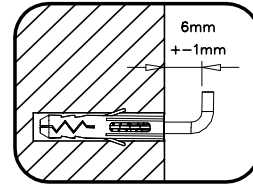

5

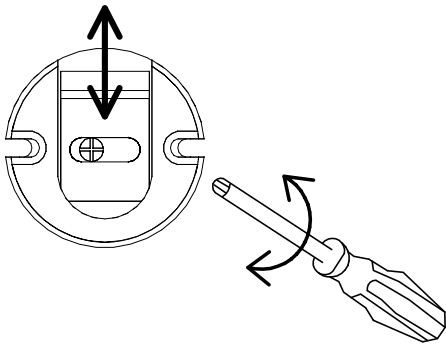
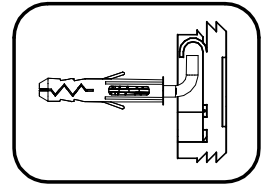

$$A = A$$

