

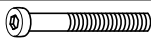







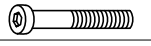

A		M8x65mm	X4
B			X1
C		M6x50mm	X14
D		M6x15mm	X4
E			X4
F		M6	X4
G		M6	X10
H			X1

1  X2	2  X2	3  X5
4  X16	5  X1	6  X2
7a  X2	7b  X2	

Step 1

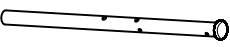
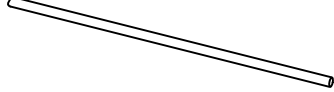
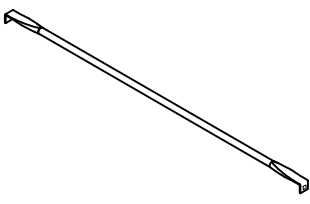
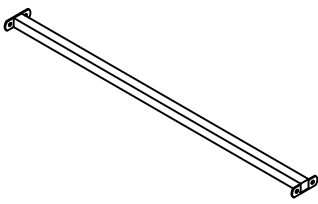
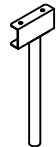
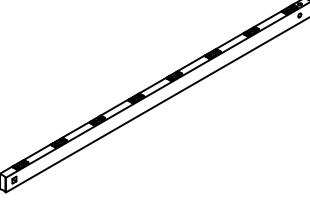
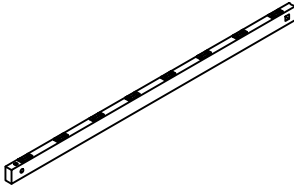
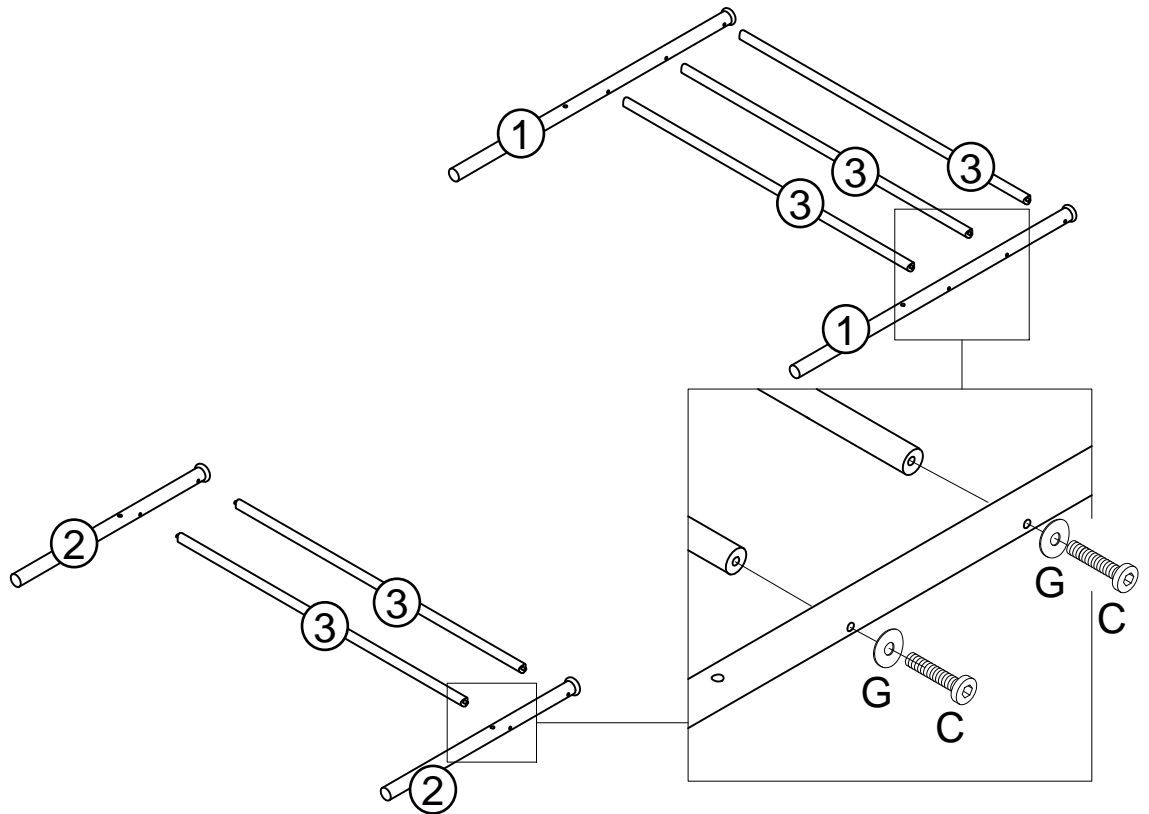



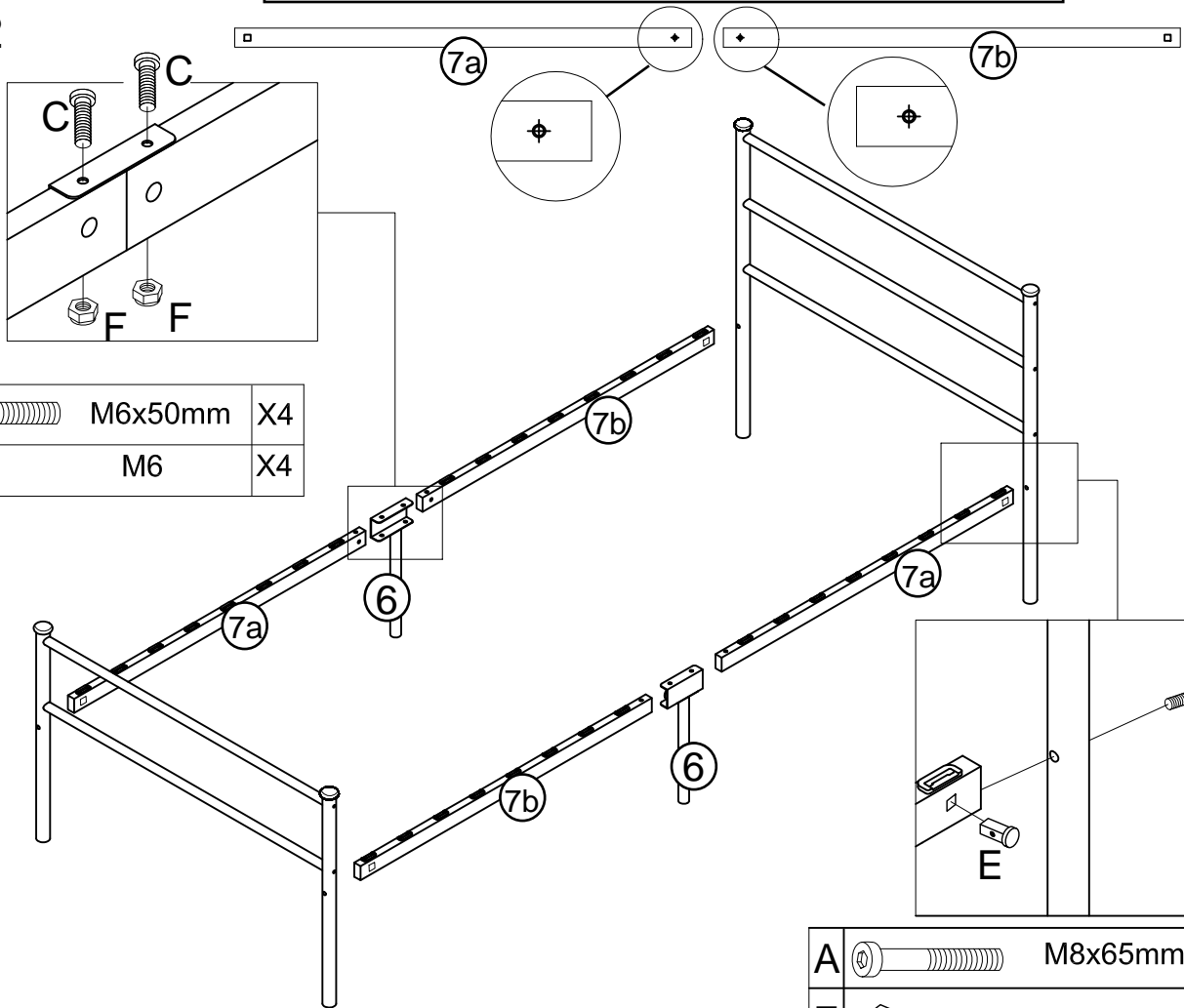

C		M6x50mm	X10
G		M6	X10

Please separate the parts 7a and 7b before beginning the assembly.

Step 2



C		M6x50mm	X4
F		M6	X4

A		M8x65mm	X4
E			X4

Step 3

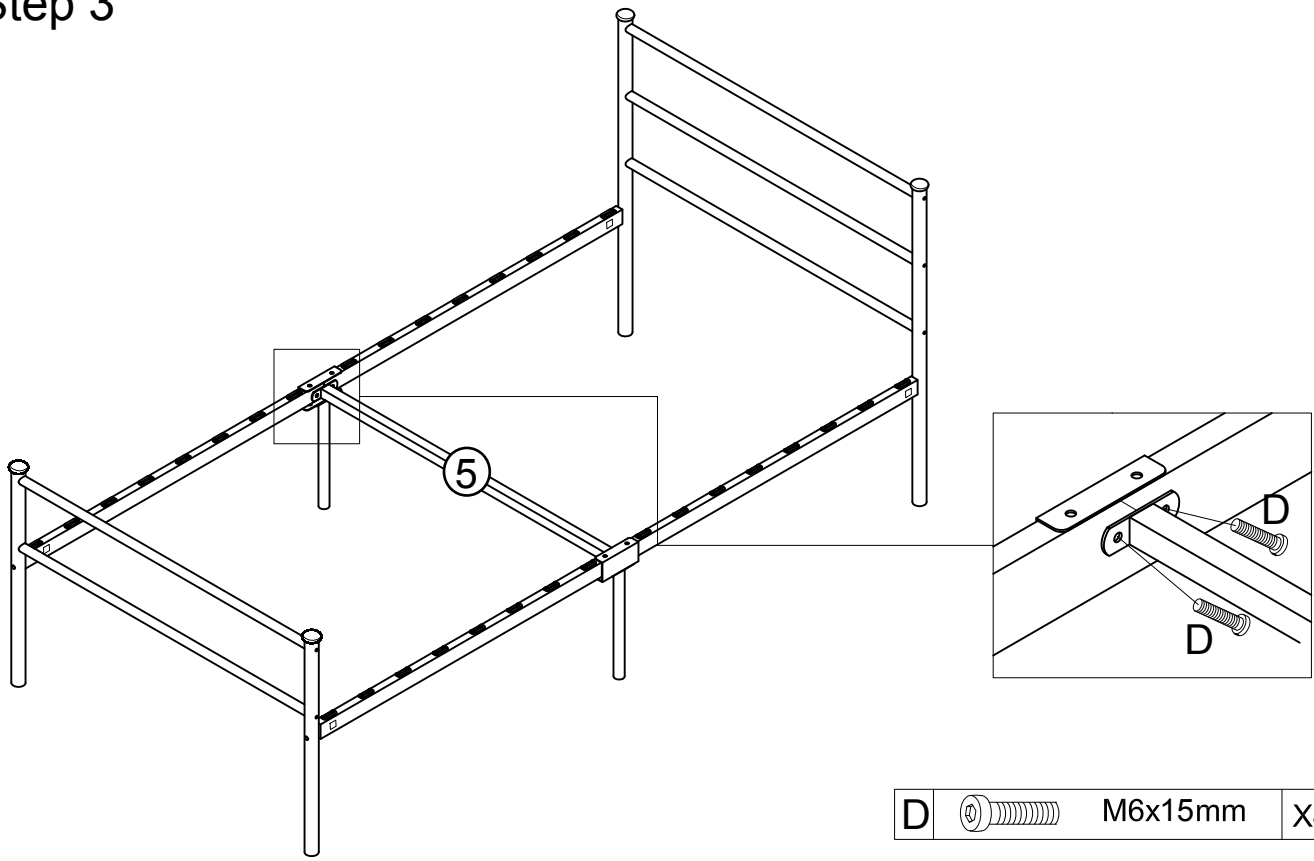

Step 4

