

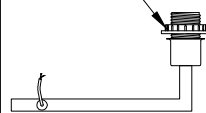

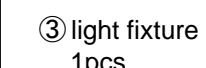

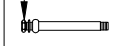

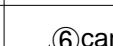



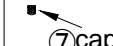

 <p>① light fixture 1pcs</p>	 <p>② socket ring</p>  <p>③ light fixture 1pcs</p>	<p>④ lock nut & teeth lock washer</p>  <p>⑤ metal tube</p>  <p>⑥ canopy</p>  <p>⑦ cap nut</p> 	<p>⑧ hex key 1pcs</p>  <p>⑨ grub screw 4pcs</p>  <p>⑩ lampshade 3pcs</p>  <p>⑪ cap connector 3pcs</p> 	<p>X 1pcs</p>  <p>X 1pcs</p>  <p>X 3pcs</p> 	<p>X 3pcs</p>  <p>X 3pcs</p>  <p>X 3pcs</p> 
--	--	--	---	--	--



Put fixture ① and fixture ③ on a flat surface, adjust two parts to a horizontal position, rotate screw ⑨ to fasten both.

1. Put the fixture ③ into fixture ①, adjust two parts straight and fasten it with grub screw ⑨ by rotate hex key ⑧.

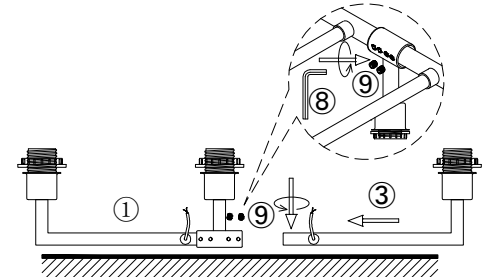
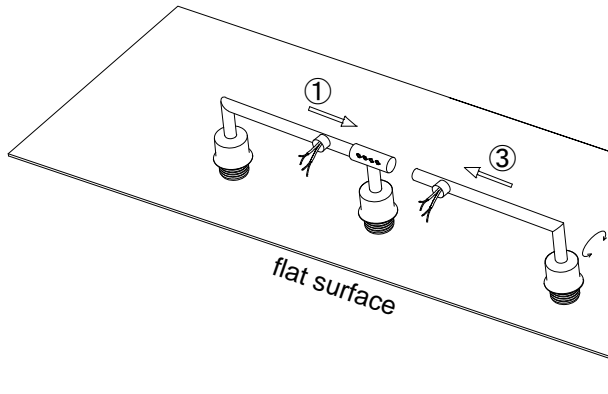
 Please operate with gloves to avoid leaving stains on the lampshade.

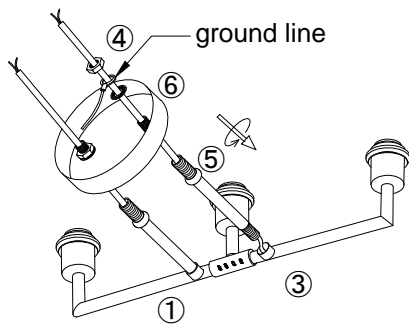

2. Let the wire of the fixture go through hanging tube ⑤, rotate to install the tubes to the fixture.
 3. Install the canopy ⑥ to the fixture with lock nut & teeth lock washer ④, ground line should be between the lock nut and washer.

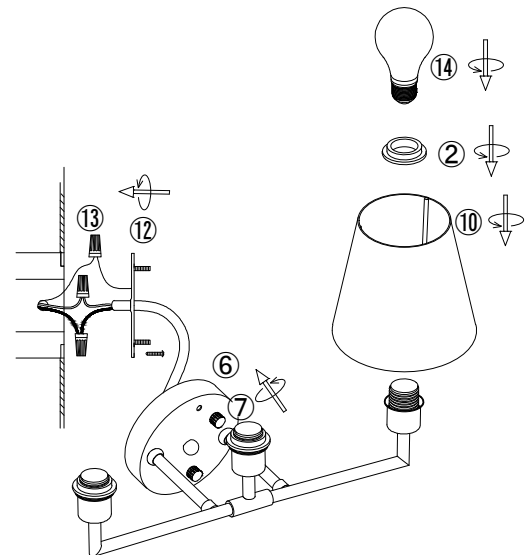

4. Install the bracket to the wall junction box with screw ⑫.
 5. Connect the wire to your home line with cap connector ⑬.
 6. Install the fixture to the bracket with cap nut ⑦.
 7. Install the lampshade ⑩ to the fixture with socket ring ②, install the bulb ⑭.

Please read carefully before installation!!!

Note : Please make sure that the electricity is powered off during installation !

Only a professional electrician should install this kind of product !