



ASSEMBLY INSTRUCTION FOR ACME FURNITURE



MODEL#DN00457

Thank you for purchasing the quality product. Be sure to check all packing material carefully for small parts which may have come loose inside the carton during shipment. Separate, identify and count all parts and metal hardware. Compare with all parts list to be sure all parts are present. If any part(s) are missing or damaged, please contact your local furniture dealer. For efficient and speedy service, please indicate the model number and code letter of part(s) needed.

***** Do not fully tighten screws until fully assembled *****

COMPONENT PARTS		
DESCRIPTION	PART NAME	QTY(PCS)
①	DINING TABLE TOP 	1
②	LEG BASE PART 	2

HARDWARE REQUIRED

- A**  ALLEN BOLT (Ø5/16*40MM) 8 PCS
- B**  FLAT WASHER (Ø5/16*2MM) 8 PCS
- C**  ALLEN KEY (M4) 1 PCS

STEP 1

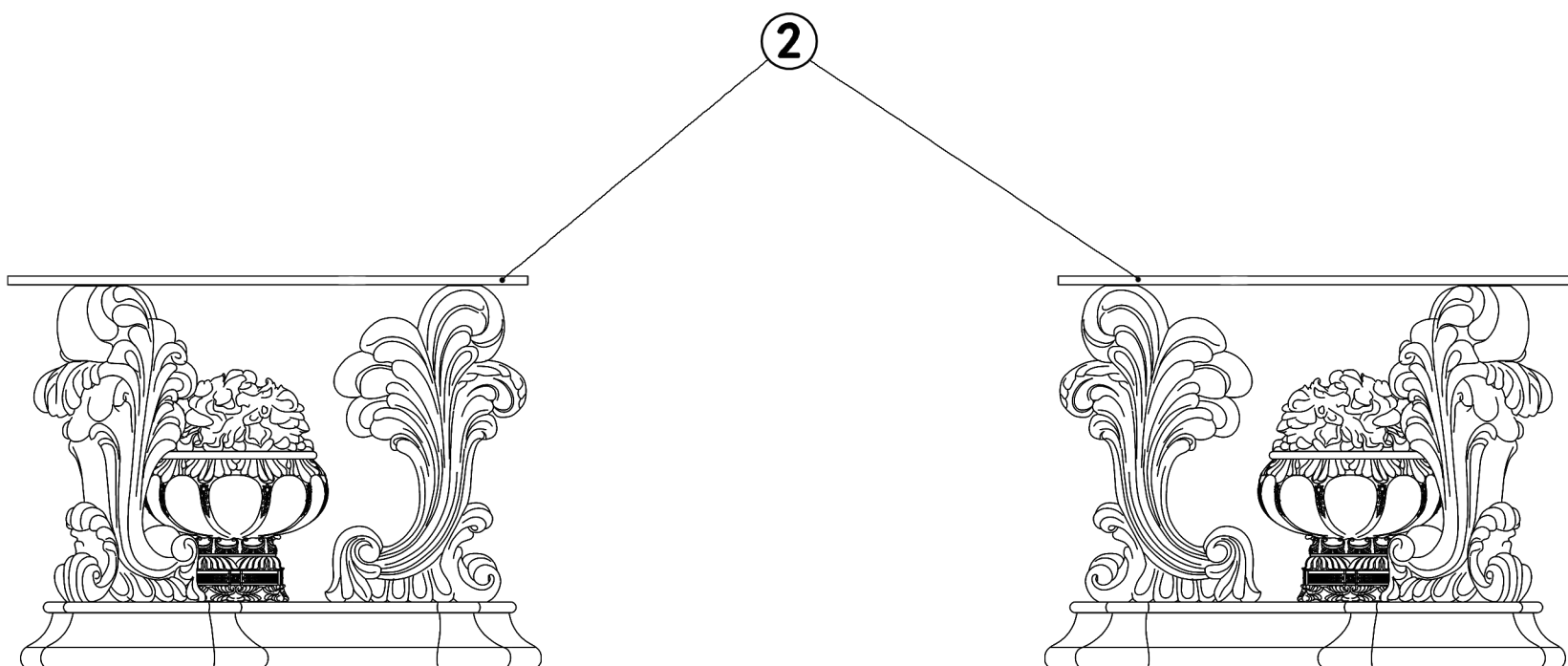

ASSEMBLY INSTRUCTION FOR ACME FURNITURE

MODEL#DN00457

Thank you for purchasing the quality product. Be sure to check all packing material carefully for small parts which may have come loose inside the carton during shipment. Separate, identify and count all parts and metal hardware. Compare with all parts list to be sure all parts are present. If any part(s) are missing or damaged, please contact your local furniture dealer. For efficient and speedy service, please indicate the model number and code letter of part(s) needed.

***** Do not fully tighten screws until fully assembled *****

STEP 2

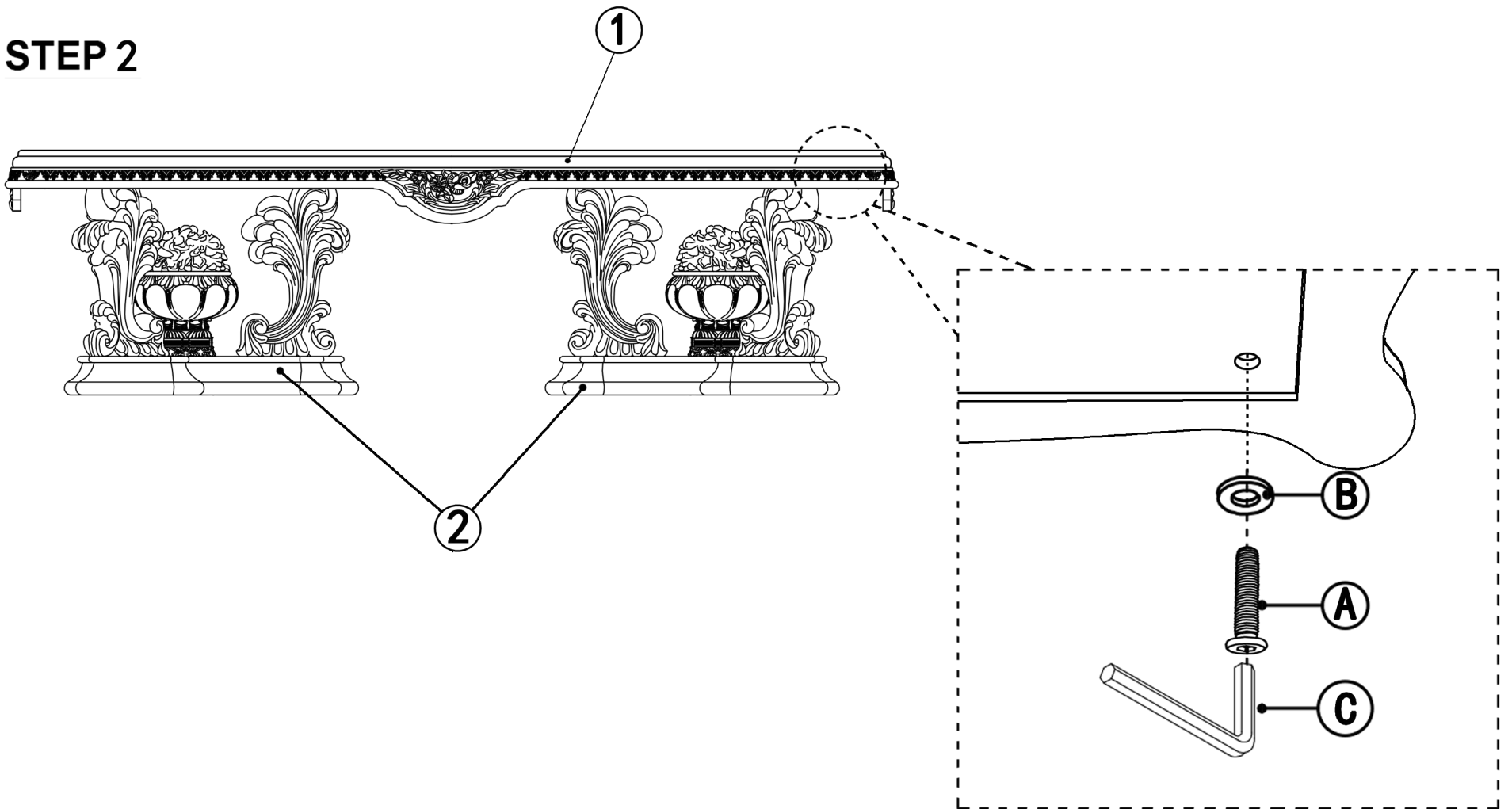

STEP 3

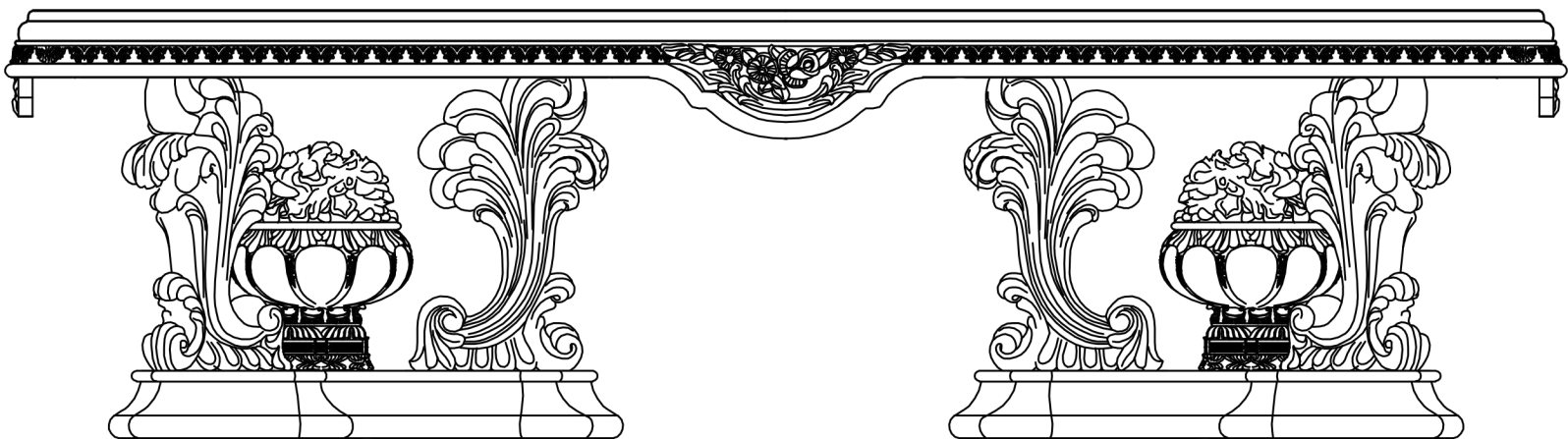

COMPLETED