

BRECKENRIDGE ELECTRIC FIREPLACE INSERT

OWNER'S MANUAL



***120V AC; 60 Hz; Maximum power 1500-Watts
All electric. No wood or charcoal. No gas. No venting required.***

⚠ WARNING

Read and understand this entire owner's manual, including **all safety information**, before **plugging in** or **using** this product. Failure to do so could result in **fire, electric shock, or serious personal injury**.

⚠ CAUTION

Keep this owner's manual for future reference. If you sell or give this product away, **make sure this manual accompanies this product**.

IMPORTANT SAFETY INFORMATION!

⚠ WARNING

- **Read all instructions before using this heater!**
- This heater is **hot when in use**. To avoid burns, **DO NOT** let bare skin touch **hot** surfaces. If provided, use handles when moving this heater. Keep **combustible materials**, such as furniture, pillows, bedding, papers, clothes, and curtains at least **3 feet (0.9m)** from the **front of the heater**, and **keep them away from the sides and rear**.
- **Extreme caution** is necessary when any heater is used by or near **children or pets** and whenever the heater is left **operating and unattended**.
- **DO NOT** operate any heater with a **damaged cord or plug** or after the **heater malfunctions**, has been **dropped** or **damaged in any manner**. Discard heater, or return to authorized service facility for examination and/or repair.
- **DO NOT** run **power cord** under carpeting. **DO NOT** cover power cord with throw rugs, runners, or similar coverings. **DO NOT** route power cord under furniture or appliances. Arrange power cord **away from traffic** area, and where it will not be tripped over.
- **Connect to properly grounded outlets ONLY**.
- **DO NOT** insert or allow **foreign objects** to enter any **ventilation or exhaust opening**, as this may cause **electric shock** or **fire**, or **damage the heater**.
- To prevent a possible fire, **DO NOT** block air intakes or exhaust in any manner. Doing so could cause a **fire**. **DO NOT** use on soft surfaces, like a bed, where openings may become blocked.
- A heater has **hot and arcing or sparking parts inside**. **DO NOT** use it in areas where **gasoline, paint, or flammable liquids** are used or stored.
- **Use this heater only as described in this manual**. Any other use not recommended by the manufacturer may cause **fire, electric shock, or injury to persons**.
- **ALWAYS** plug heaters directly into a wall outlet/receptacle. **NEVER** use with an extension cord or relocatable power tap (outlet/power strip).
- **DO NOT** place the heater near a bed because objects such as pillows or blankets can fall off the bed and be ignited by the heater.
- **NEVER** use this heater in **bathrooms, laundry rooms**, or any other location where the heater could fall into a **bathtub** or **pool**, **become damp**, or **come in contact with water**.
- **AVOID FIRE!** Regularly inspect all air vents to make sure they are free from dust, lint, or other blockage. **Unplug the unit** and clean with a **vacuum ONLY**. **DO NOT** rinse or get wet.

- **Use only** the electric insert with **included mantel**. **NEVER** use a mantel from **another maker**.
- **NEVER** use this electric fireplace insert **unless** it is **properly installed** in the correct mantel.
- **AVOID INJURY FROM TIPPING!** Anchor the TV, or other items, to the wall with the anti-tip kits supplied by the manufacturer.
- **NEVER** sit, stand, or climb on this electric fireplace. Doing so **could cause the unit to tip over**, resulting in **serious personal injury or property damage**.

WARNING

- **For residential use only! NOT for commercial use!** Any commercial or public use of this heater **voids all warranties**, and could cause **injury**.
- This product is **not intended** to be a **primary heat source**. It is for **supplemental heat only**.
- **INDOOR use only! NEVER** use this heater **outdoors!** Doing so may result in **electric shock!**
- **Risk of electric shock! DO NOT OPEN!** No user-serviceable parts inside!
- **NEVER modify this heater**. Doing so could result in personal **injury** or property **damage**. Modification of this fireplace **completely voids all warranties**.
- **ALWAYS** turn this heater off before unplugging it from the outlet.
- **ALWAYS disconnect** this unit from the **power** supply **before** performing any assembly or cleaning, or before relocating the electric fireplace.
- **NEVER** leave this heater unattended. **ALWAYS** unplug this heater when not in use.
- **ALWAYS** store this heater in a dry location. **NEVER** use the fireplace if it has become wet.
- Place the heater near a wall outlet so an extension cord is not needed. If an extension cord is needed, the **gauge** of the cord **must be at least 14AWG**, and the **rating must be at least 1875 Watts**. **NEVER** use a **smaller gauge** cord with a **lower rating**. Doing so may result in **fire or electric shock**.
- **ONLY** use this heater on a **120V AC 15-amp grounded circuit**. **NEVER overload the circuit**. If this heater trips the circuit breaker, unplug all other appliances on the same circuit before the next use. Avoid plugging other appliances into the same circuit as this heater.
- **NEVER** plug this heater into an outlet that is **old, cracked**, or has any **loose wires or connections**. Plugging this heater into a faulty outlet could result in **electric arcing** within the outlet that could cause the **outlet to overheat or catch fire**.
- **ALWAYS** check your heater cord and plug connections with **each use!**
 - i) **MAKE SURE** the plug fits tight in the outlet! Faulty wall outlet connections or loose plugs can cause the outlet to overheat.
 - ii) **Heaters draw more current** than small appliances. **Overheating** may occur even if it has not occurred with the use of other appliances.
 - iii) During use **check frequently** to see if the **plug outlet or faceplate** is **HOT!**
 - iv) If the outlet or faceplate is **HOT**, **discontinue use immediately** and have a qualified electrician inspect and/or replace the faulty outlets.

- The power cord supplied with the heater has three prongs: two flat blades (live and neutral) and one round pin (ground). If a 3-slot receptacle is not available, an adapter **MUST** be used. The adapter **MUST** be **properly grounded** to the outlet box (see figure at right). [NOTE: Adapter NOT INCLUDED.]

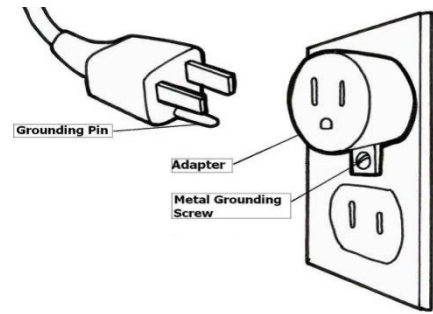

- **SAVE THESE INSTRUCTIONS!**

PREPARATION



This insert has a front panel made of **GLASS!** **ALWAYS** use **extreme caution** when handling **glass**. Failure to do so could result in **personal injury** or **property damage**.

NOTE: Remove all parts and hardware from the carton and place them on a clean, soft, dry surface. Check the parts list to make sure nothing is missing. Dispose of packaging materials properly. Please recycle whenever possible.

Tools required for installation:  Phillips screwdriver (Not included)

ELECTRIC INSERT: PARTS & HARDWARE

Item	Description	Qty
A	Fireplace Insert	1
B	Remote Control	1
C	Screws (4*8)	8
D	Screws (4*12)	8
E	L-shaped plate	4

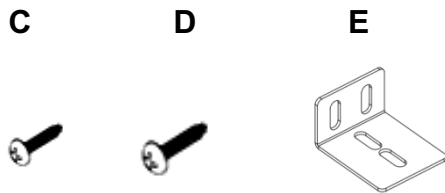
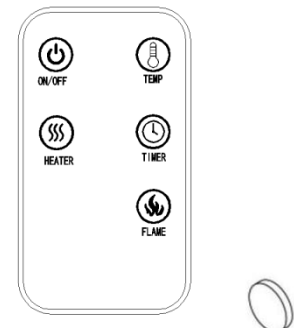
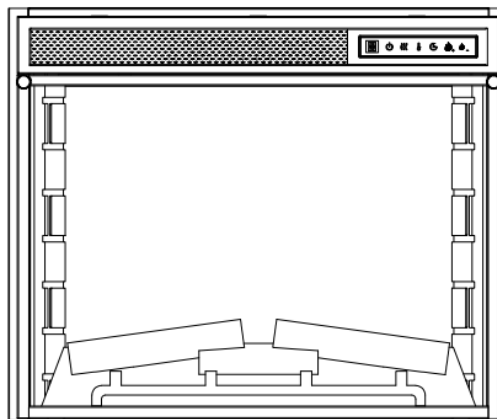

A

B

The remote control operates with one 3V CR2032 Lithium Cell Battery (included).

Remote Control Set-up

- **Fig. 1:** Remove the plastic sheet from the end of the remote control to allow the battery to touch the electrical contacts. **If the sheet is not removed, the remote control will not work.**
- **Fig. 2:** To install or replace the battery, press the button to allow the battery case to slide out. Position the battery according the drawing, and slide the case back in to the remote.

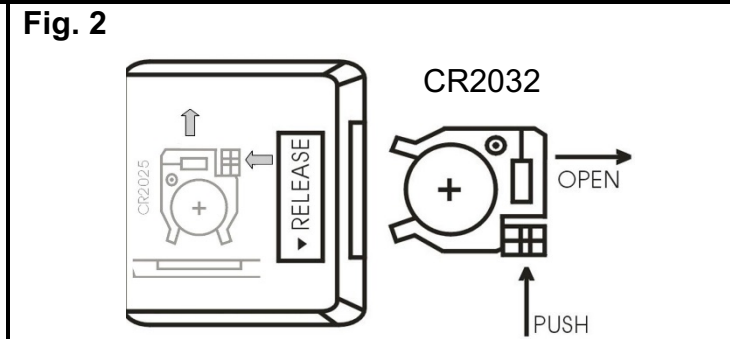
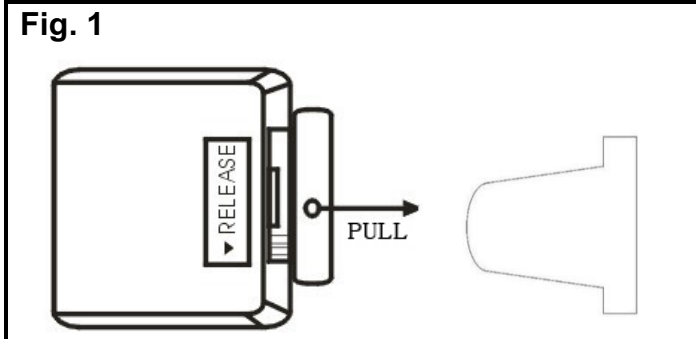

! **NEVER** dispose of batteries in **fire**. Failure to observe this precaution **may result in an explosion**. Dispose of batteries at your local hazardous material processing center.

! **ALWAYS** replace the battery in the remote control with the **same type of battery**. Failure to do so may result in **personal injury** or **property damage**.

⚡ **ALWAYS unplug** this fireplace heater **before assembly** or **cleaning**, or **before relocating**. Failure to do so could result in **electric shock**, **fire**, or **personal injury**.

ELECTRIC INSERT INSTALLATION INTO MANTEL

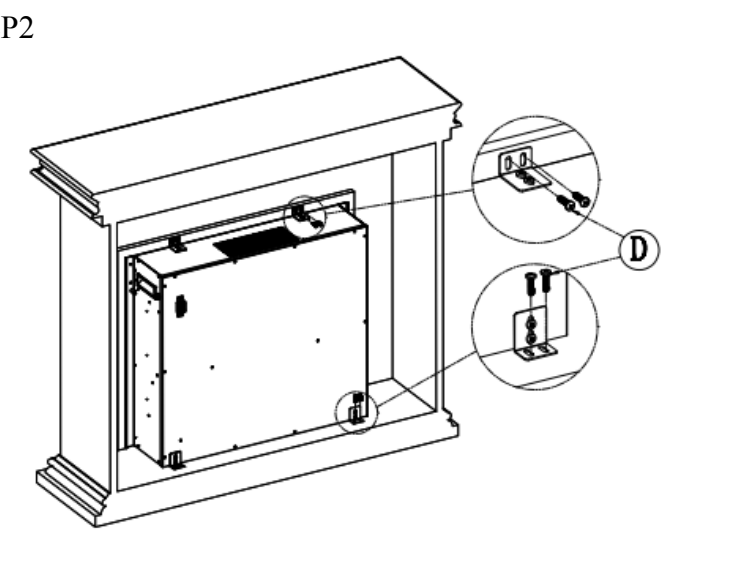
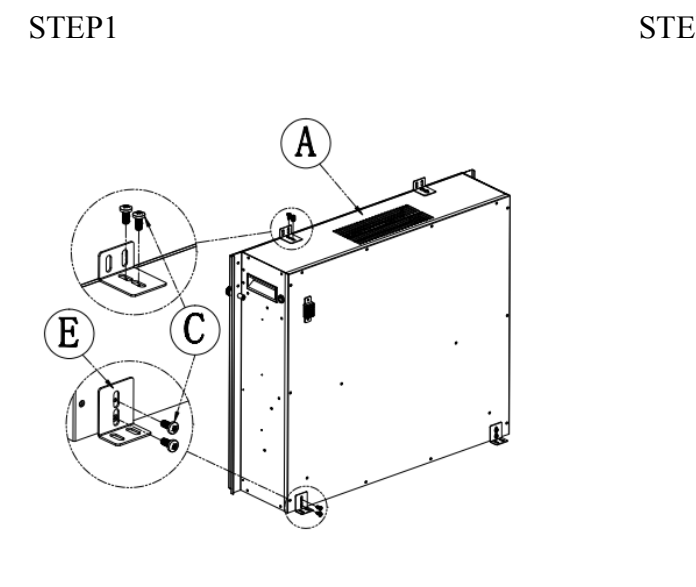

NOTE: DO NOT attempt to install the insert from the **front** of the mantel - it will not fit.

Step 1. Fix the 4 L-shape plates E to the back of the insert A with 8pcs screw C.

Step 2. With the help of an adult assistant, lift the insert carefully into the back of the mantel. Use care not to drag the insert across the mantel base, as it could scratch the wood surface.

Step 3. From the front of the mantel, check to make sure the fireplace insert is properly aligned. Then fix the L-shaped plate E to the mantel with 8 pcs screw D. **DO NOT OVER-TIGHTEN.**

OPERATION



Read and understand this entire owner's manual, including **all safety information**, before plugging in or **using** this product. Failure to do so could result in **electric shock, fire, serious injury, or death.**

Power

Make sure the ON/OFF switch, located on the control panel, is in the OFF position. Plug the power cord into a 120V AC, 15 Amp grounded outlet (see **IMPORTANT SAFETY INFORMATION** on **Pages 2 and 3**). Make sure the outlet is in good condition and that the plug is not loose. **NEVER** exceed the maximum amperage for the circuit. **DO NOT** plug other appliances into the same circuit.

Temperature Limiting Control

This heater is equipped with a Temperature Limiting Control. Should the heater reach an unsafe temperature (239°F / 115°C), the heater will automatically turn OFF. To reset:

1. Unplug the power cord from the outlet.
2. Turn the ON/OFF switch on the CONTROL PANEL to OFF. **Wait 15 minutes.**
3. Inspect the fireplace to make sure no vents are blocked, or clogged with dust or lint. If they are, use a vacuum to clean the vent areas.
4. With the POWER switch in the OFF position, plug the power cord back into the outlet.
5. If it switches off again, **UNPLUG THE HEATER RIGHT AWAY!** Have the outlets, wiring, and breaker box inspected by a professional. Make necessary repairs before using the heater.

MOBILE PHONE CONTROL FUNCTIONS

Step1. Scan below QR code and download the “Smart Life” app on your mobile phone.



Step2. Open the Smart Life app and Log in.

If you have existing account, log in directly. Or you need to log in with your wechat / QQ account, or register follow below steps.

1. Click “Register”
2. Agree the Privacy Policy
3. Choose your country and input your mobile phone number or email, click” Get Verification Code”

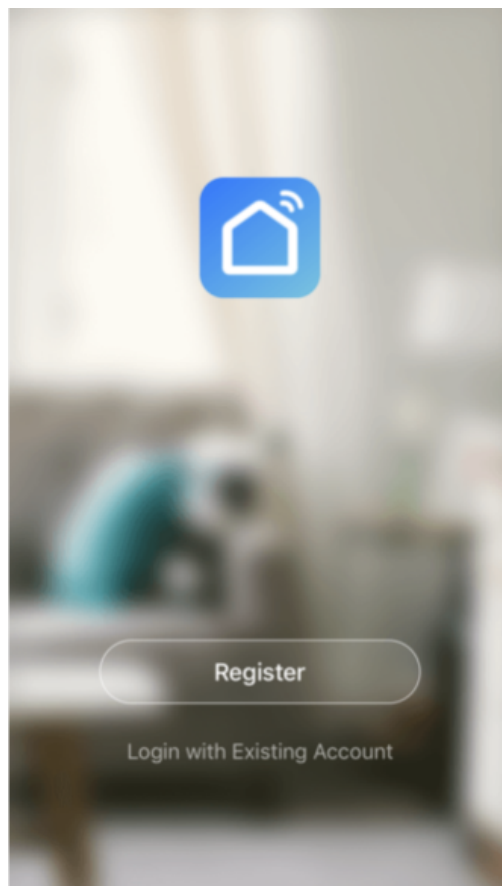

4. The verification code will be sent to your mobile phone or email box, check and enter the right code in 60 seconds, or it will need to be resent
5. Set the password. It should contain 6 to 20 characters, including letters and digits. Then you have registered successfully

Step 3. Add Device

1. Make sure the room which your fireplace in has wi-fi
2. Make sure your mobile phone has connected the room's wi-fi or hotspot
3. Click "Add Device"
4. Choose "Small Home Appliance", and choose "Heater"
5. Power on the fireplace, and confirm the power light rapidly blinks (2 times per second)

Notice: If the power light doesn't flash, click "Help", and follow the below 3 steps.

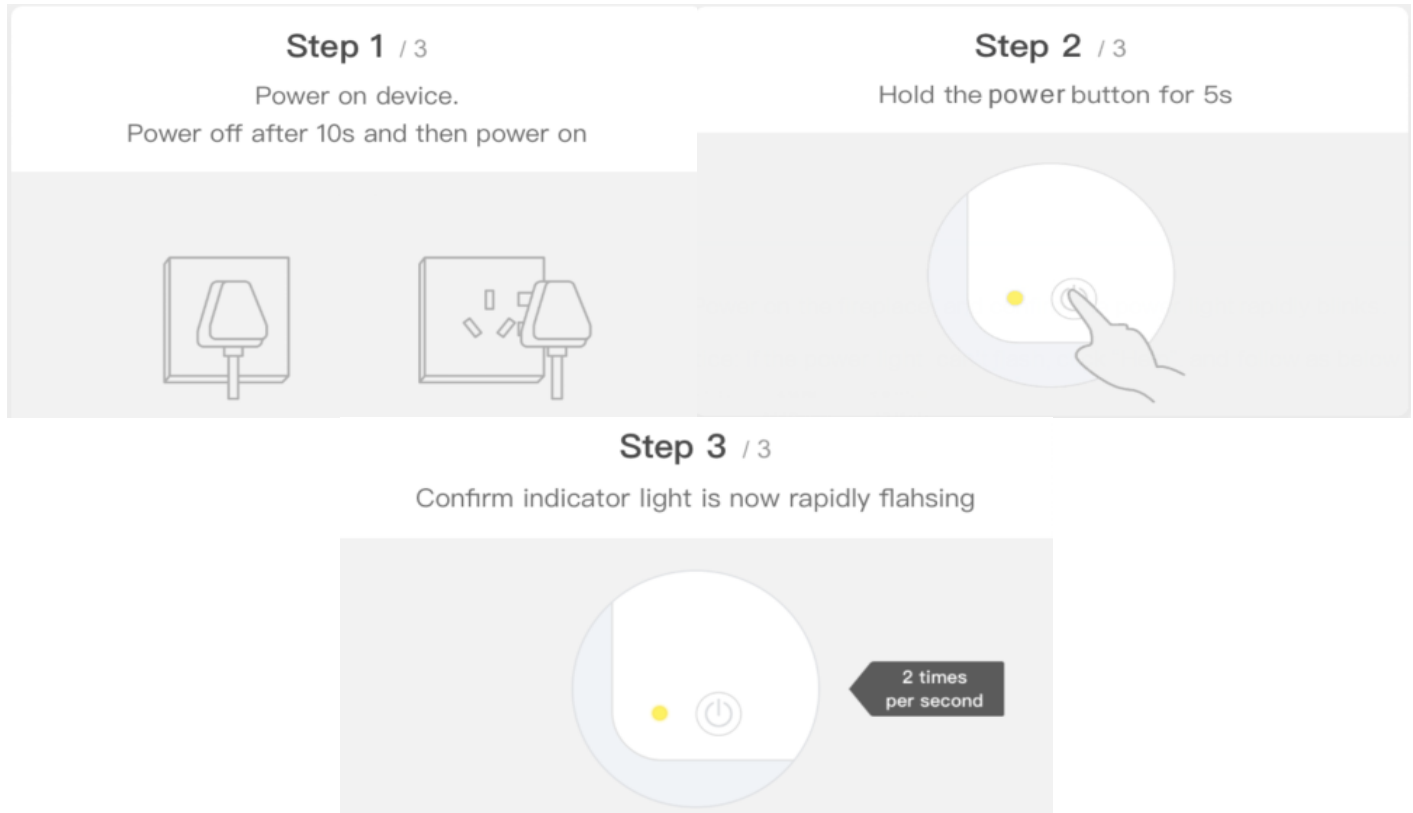

6. Enter the room's wi-fi name and password, or hotspot's name and password. Make sure the fireplace and mobile phone have connected using the same wi-fi or hotspot. Then click "confirm".

Notice: After you add the device successfully, your mobile phone can control the fireplace from anywhere with wi-fi or another network. But you should keep the fireplace always connected to the room's wi-fi or hotspot. If the fireplace is off the network, the power light will be flashing.

7. Put your mobile phone near the fireplace, and wait for it to connect to the fireplace automatically. When it runs to 100%, you have connected successfully.

Notice: When the fireplace is out of network, the power light will be always bright. Please connect the fireplace with network following step 3.

How to control the fireplace on the app

Power button: Press once to turn on the fireplace. Press again to turn off the fireplace.



Heat Settings:

1. Click "Add Device"

Slide your finger to adjust the temperature from 60 F - 82 F.

Heating Settings



2. Press the "level 1" button, the heater will start to operate, 750W (LOW HEAT) heater turns on and the fan starts to blow warm air. Press the "Level 2" Button 1,500W (HIGH HEAT) heater turns on and blows hot air. Press "off" button, the heater turns OFF. The fan will continue to blow to allow heater to cool down, and then turns off.



OFF



Level 1



Level 2

Flame Brightness:

Slide your finger to adjust the flame brightness. Three levels: Low, Medium and Bright.

Flame Brightness



Low



Medium



Bright

Timer:

Slide your finger to set the timer function from 0h to 8h.



Countdown Timer



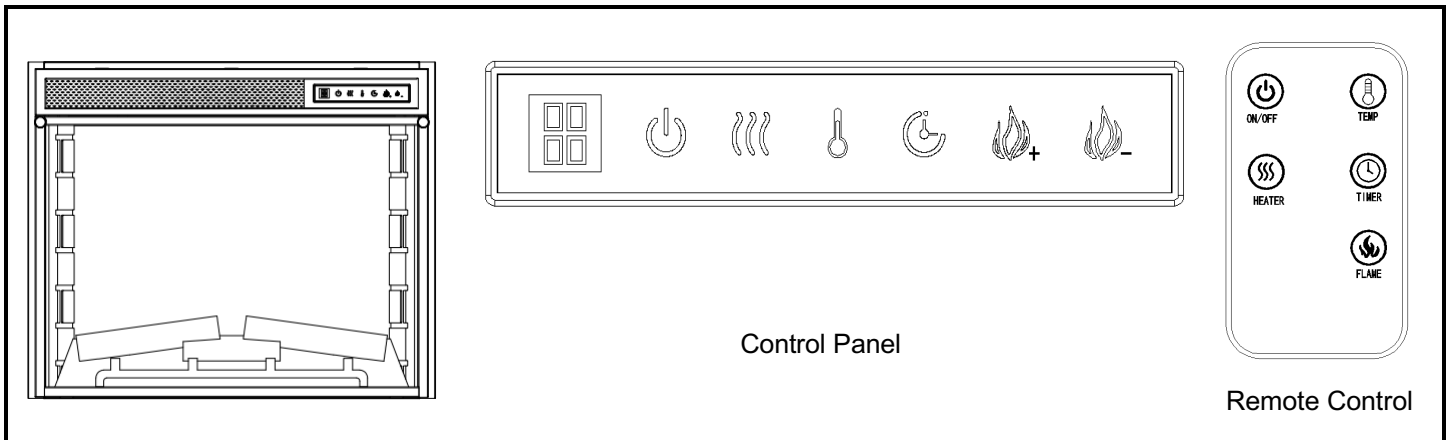

Control Panel, Heat Enabling Switch, and Remote Control



Control Panel and Remote Control Operation

BUTTON	OPERATION	NOTES / INDICATONS
 ON/OFF	Press the POWER button to turn the fireplace on and off. The POWER button turns the flame effect on and off	The power must be turned ON for the control panel and remote control to work. When the fireplace is turned on, after being turned off, the previous settings will resume.
 FLAME	Press to cycle the flame effect from High, to Medium, to Low, and then back to High. Press the POWER button to turn off the flame effect.	The power must be turned on for the flame effect to work. The ember effect automatically varies between light and dark to simulate real embers. It cannot be controlled.
 TEMP	Press to set the thermostat. The set temperature appears in the control panel digital display. The thermostat will automatically turn the heater on and off to maintain the set temperature. Settings start at 68°F, then increase by 60°F up to 82°F. Press again to turn the heater off. The digital display will go dark.	The flame effect must be on for the heater to turn on. If off, the heater will not turn on. The heater will only turn on when the thermostat setting is higher than room temperature. When the room temperature reaches the thermostat setting, the heater will turn off. To prevent overheating, the fan blows cool air for 8-10 seconds before the heater turns on, and after the heater turns off.

 HEAT	press to turn the heater on and off ,then turn on or off the heating function .Note:The flame effect must be on for the heater to work	Turn on the heating function ,the fan blows hot air ,also the fan may continue to blow air for a short time to cool the fireplace after turning off the heating function .
 TIMER	The TIMER will turn the fireplace off after a certain amount of time. Press the TIMER button to select from the following settings: 00 (off), 1H, 2H, 3H, 4H, 5H, 6H, 7H, 8H. Once at 8H, press the button again to return to 00 (off).	The timer settings will appear in the digital display.

NOTICE To improve operation, **DO NOT press the buttons too quickly.** Give the unit time to respond to each command.

! WARNING **NEVER leave heater unattended during operation!** Failure to do so could result in **personal injury or property damage.**

NOTICE When the heater is first turned on, a slight odor may be present. This is normal and should not occur again unless the heater is not used for a long period of time.

CARE AND MAINTENANCE

 **ALWAYS** turn the heater **OFF** and **unplug the power cord from the outlet** before cleaning, performing maintenance, or moving this fireplace. Failure to do so could result in **electric shock, fire, or personal injury.**

Cleaning

 **NEVER immerse in water or spray with water.** Doing so could result in **electric shock, fire, or personal injury.**

Wood:

- Wipe gently with a slightly damp cloth.
- **NEVER** use abrasive cleansers, liquid sprays, or any cleaner that could scratch the surface.

Metal:

- Buff using a soft cloth, slightly dampened with a citrus oil-based product.
- **DO NOT** use brass polish or household cleaners as these products will damage the metal trim.

Glass:

- Use a good quality glass cleaner and dry thoroughly with a paper towel or lint-free cloth.
- **NEVER** use abrasive cleansers, liquid sprays, or any cleaner that could scratch the surface.

Vents:

- Use a vacuum or duster to remove dust and dirt from the heater and vent areas.
- Clean the exterior of the fireplace with a slightly damp cloth or duster.

Maintenance



Risk of electric shock! DO NOT OPEN! No user-serviceable parts inside!



ALWAYS turn the heater **OFF** and **unplug the power cord from the outlet** before cleaning, performing maintenance, or moving this fireplace. Failure to do so could result in **electric shock, fire, or personal injury.**

Electrical and Moving Parts:

- The fan motors are lubricated at the factory and will not require lubrication.
- Electrical components are integrated in the fireplace and are not serviceable by the consumer.

Storage:

- Store heater in a clean dry place when not in use.



WARNING! No servicing should be performed by the consumer. **DO NOT** repair or service the unit yourself. For service, **call a certified electrician.**

TROUBLESHOOTING GUIDE

PROBLEM	SOLUTION
There is no power to the unit.	<ol style="list-style-type: none"> 1. Make sure the power cord is plugged into a working 120V AC electrical outlet. 2. Check for a tripped circuit breaker, or a blown fuse. 3. If the unit had been working, but then turned off by itself, the temperature limiting control must be reset. Please see instructions on Page 5.
The control panel doesn't work.	Make sure the ON/OFF switch on the control panel is turned on.
The flame effect does not work.	Make sure the ON/OFF switch on the control panel is turned on.
The flame effect does not turn off when I press the flame button.	The flame effect stays on until the ON/OFF switch is turned off.
The heater does not work.	<ol style="list-style-type: none"> 1. Make sure the heat enable switch on the side of the insert is turned ON. If not, the heater will not turn on. 2. Make sure the ON/OFF switch on the control panel <u>and the flame effect</u> are both turned on. The heater will not work unless the flame effect is on. 3. Make sure the thermostat is not set too low. If the thermostat is set lower than room temperature, the heater will not turn on.
Hot air does not blow when the heater is first turned on.	The fans blow cool air before the heating elements turn on, and after they turn off, to prevent overheating. This is normal.

The remote control does not work.	<ol style="list-style-type: none"> 1. Make sure the battery is properly installed, and the plastic tab is removed. 2. Make sure the ON/OFF switch on the control panel is turned on. The remote control will not work unless the ON/OFF switch on the control panel is turned on. 3. Remove objects that may be in the way. Aim the remote control at the receiver in the center of the front panel. 4. Don't press the remote control buttons too quickly. Give the unit time to respond to your commands.
The power cord , or the outlet faceplate, is hot.	Turn the heater off immediately. Wait for the cord to cool and unplug the heater. See the warnings on Page 4 for possible causes. Call an electrician to examine your home's wiring.
The thermostat (TEMP button) does not work.	<ol style="list-style-type: none"> 1. Make sure the heater is turned on. The thermostat will not work unless the heater is turned on. 2. Make sure the thermostat is not set too low. If the thermostat is set lower than room temperature, the heater will turn off. 3. If the thermostat was overridden by the heater button, press the temp button to restart the thermostat.

FAQ - FREQUENTLY ASKED QUESTIONS

Question	Answer
<i>Can I leave the heater running overnight?</i>	No. This heater is not intended to be a primary heat source. It is designed to provide supplemental heat, and should not be left running continuously for more than eight hours.
<i>Is the fireplace safe to use on carpet?</i>	Yes. However, please note the warnings on Pages 2 and 3 about the safe placement of the heater. The vents must NEVER be blocked, and must always be kept clear. The insert must ALWAYS be used WITH the mantel, never by itself. Use on the carpet may require additional cleaning of the vents with a vacuum.
<i>How much does it cost each month to run the heater?</i>	Example: 1500 Watts equals 1.5 Kilowatt Hours (KWH). Contact your utility to find out the cost per KWH. Then, use this formula: 1.5 x (\$0.00/KWH) = \$0.00 per hour. For example: If the utility charges \$0.20 per KWH, then the cost is 1.5 x \$0.20 = \$0.30 per hour. If you run the heater 5 hours per day, the cost will be 5 x \$0.30 = \$1.50/day. 30 days x \$1.50 = \$45.00/month.
<i>Should the motor be loud when the heater is running?</i>	No. The flame effect motors and heater blowers are not silent, but they should not be loud. Since these motors are not serviceable by the consumer, the product will need to be returned to the store.
<i>Can I get replacement parts for my electric heater?</i>	Some parts can be replaced. Please contact our Customer Service representative to check availability.

LIMITED WARRANTY

This warrants to the original purchaser that this product is free from defects in material and workmanship as of the date of purchase and that it will, under normal use and proper care, remain so for 1 year from the date of purchase. Missing or initially defective parts will be replaced free of charge during the period of this limited warranty. If parts are unavailable, comparable replacement or refund will be given. The original dated sales receipt is required for all warranty claims. This warranty does not cover damage which has occurred during transport from the point of purchase to the consumer's home. This warranty does not cover glass, lightbulbs, or batteries.

This product is for residential use only. Any and all commercial use of this product voids all warranties, and frees the manufacturer from all liability. Read and fully understand all assembly and operating instructions, and all safety information and warnings, before use. The following will void this warranty: damage caused by tampering with, modifying, or altering the electric fireplace in any manner; damage due to incorrect assembly, improper care, misuse, or abuse; damage from being used with the wrong power source; water damage; damage caused from the electric fireplace being used outdoors; damage caused from the electric fireplace being used for excessive periods of time; damage caused by the electric fireplace being used in any commercial application; damage from use as a primary heat source; other misuse and abuse not specifically listed herein.

This product is not intended to be used as a primary heat source. It's directors, officers, or agents, will not be liable to the purchaser or any third party, whether in contract, in tort, or on any other basis, for any indirect, special, punitive, exemplary, consequential, or incidental loss, cost, or damage arising out of or in connection with this sale, maintenance, use, or inability to use this product, even if its directors, or agents have been advised of the possibility of such losses, costs, or damages that exceed the purchase price of the product. Some states do not allow the exclusion or limitation of incidental or consequential damages, so the above limitation or exclusion may not apply to the purchaser. This limited warranty gives you specific legal rights, and you may also have other rights, which vary from state-to-state.