

Recliner Assembly Instructions

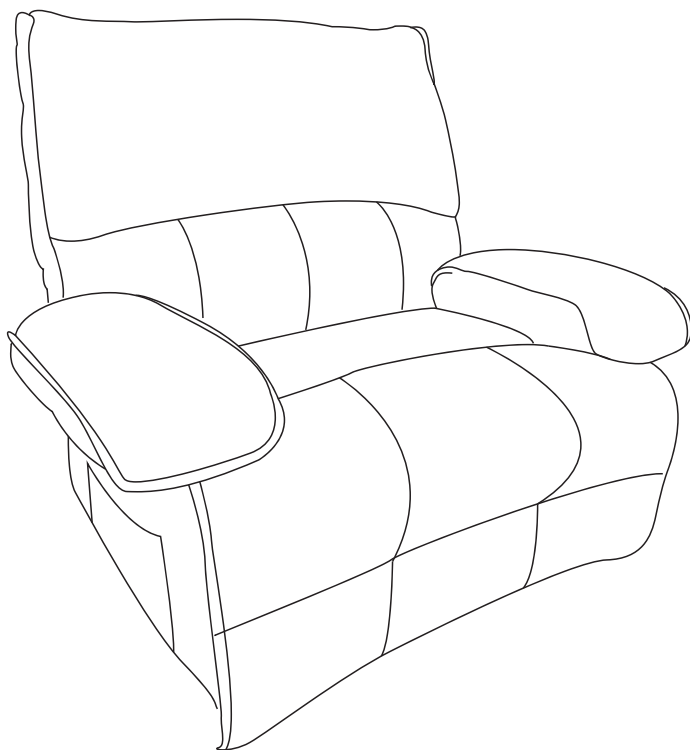

NOTE: Your recliner is packed in 2 separated boxes. You will find the following listed parts inside the 2 separated boxes.

BOX A	BOX B
2X1	1 X1
3X1	
4 X2	
5(L R) X1	
6 X1	
7X2	
A	
B	
C	

**Please turn the seatbase over and
Find the components: A, B, C,5-R**

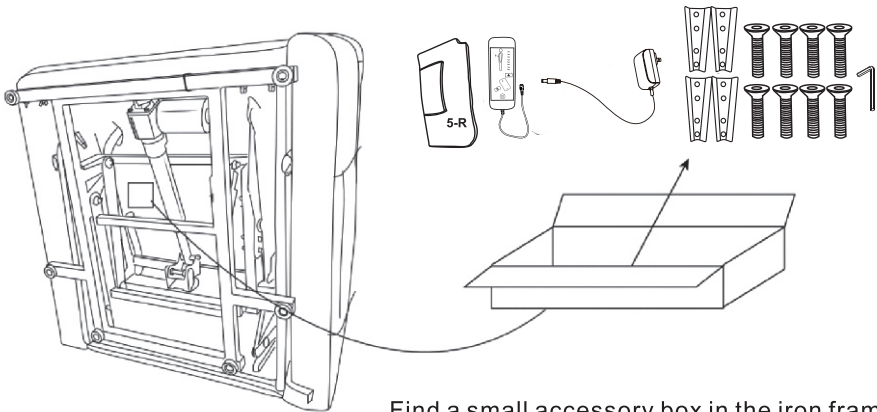

Find a small accessory box in the iron frame, take them out and assemble the accessories on the sofa

Accessories Display

CAUTION: Please check and ensure all the things are in the package. You can contact us if something is not included. We will reply within 24 hours and try our best to solve it.

- * Backrest and armrests are packed in a compression bag
- * The backrest you received has been vacuum-packed. Open the plastic bag and take out the backrest. Gently pat it for a while and make it more puffy.
- * **Able to recover up to 95% of its elasticity after a maximum of 7 hours.**

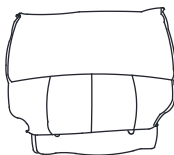

1. Back Cushion* 1pc

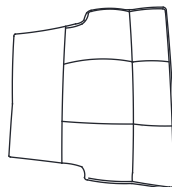

2. Sofa cushion soft bag*1pc

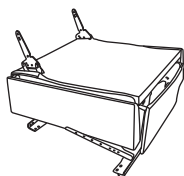

3. Seat* 1pc



4. Armrest Pillow R&L*2pc

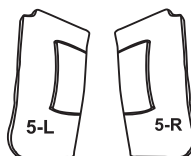

5. Armrest* 2pc

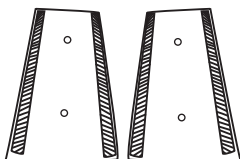

6. arm plywood*2pc



7. Sponge pad*1pc



8. Screw* 8 pcs



A Remote Control *1pc



B Power Cord *1pc

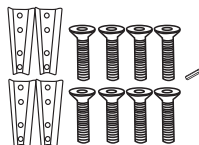

C Screw accessory package

* For the accessories in the pictures above, you will find them at the bottom of seatbase when you pull out the reclining handle.

Frame Assembly

CAUTION: At least two adults are required to safely complete performing this task.
Other lifting attempts may risk back injury due to large and heavy part(s).

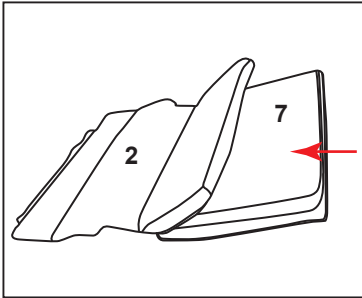

01

Place sponge bag 7
in sofa cushion soft pack 2
and sew the zipper together

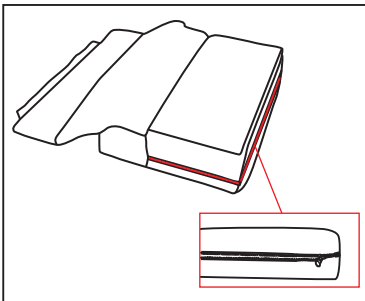

02

Make sure to zip up sofa cushion.

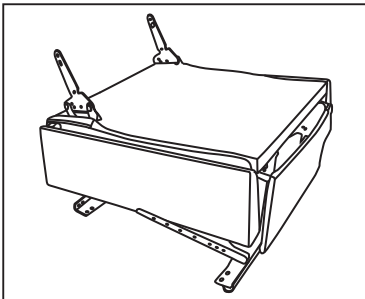

03

Find out seat frame 3.

Frame Assembly

CAUTION: At least two adults are required to safely complete performing this task.
Other lifting attempts may risk back injury due to large and heavy part(s).

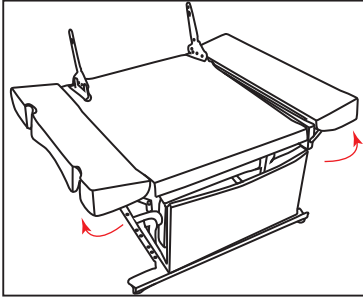

04

Gently unfold the folding frame on both sides until it clicks into place.

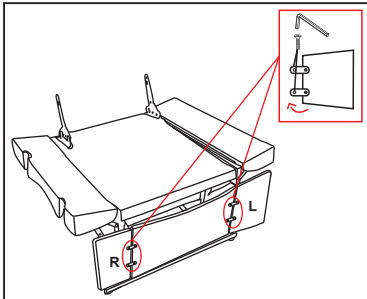

05

Part 9 is attached to cushion 3 with screw 8.

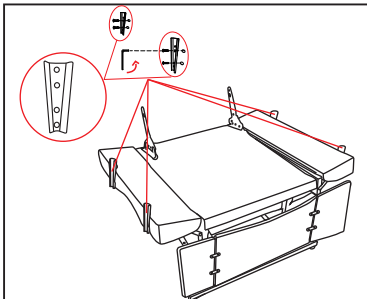

06

Part C is with screw attached to cushion 3 with screw C.

CAUTION: At least two adults are required to safely complete performing this task.
Other lifting attempts may risk back injury due to large and heavy part(s).

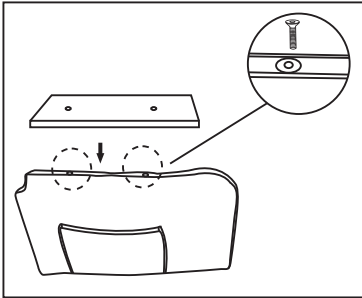

07

Please use screws 8 with spacers to attach the boards to the handrail with the dual lock positioned down to face the floor.

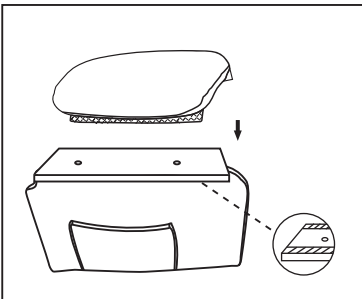

08

Please attach the softhook on the foam armrests to the dual lock underneath the boards.

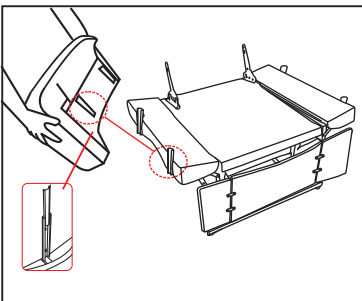

09

Align the pin on the armrest with the pin on the seat frame, then push down to install the armrest onto the cushion.

CAUTION: At least two adults are required to safely complete performing this task.
Other lifting attempts may risk back injury due to large and heavy part(s).

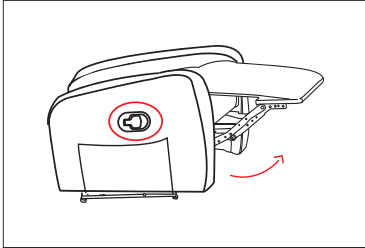

10

Pull the pull handle to open the foot pedal.

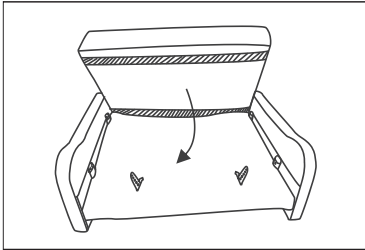

11

Place the installed sofa seat cushion on seat frame and paste it together.

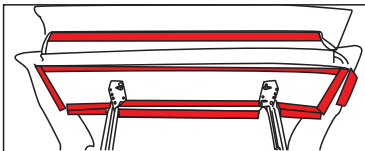

12

Past seat cushion 2 to the seat 3 footrest plywood.

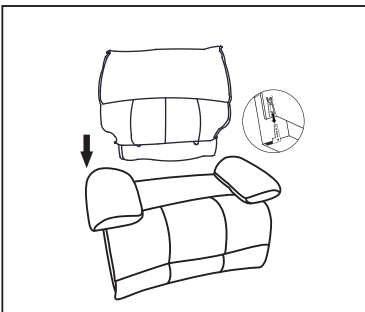

13

Align the pins of the backrest with the pins of the seat, and press downward to assemble the backrest and seat; Try shaking the backrest after installation, if one side wobbles up and down, it is not fully assembled.

Please make sure to hear a 'click' sound

Wire Assembly

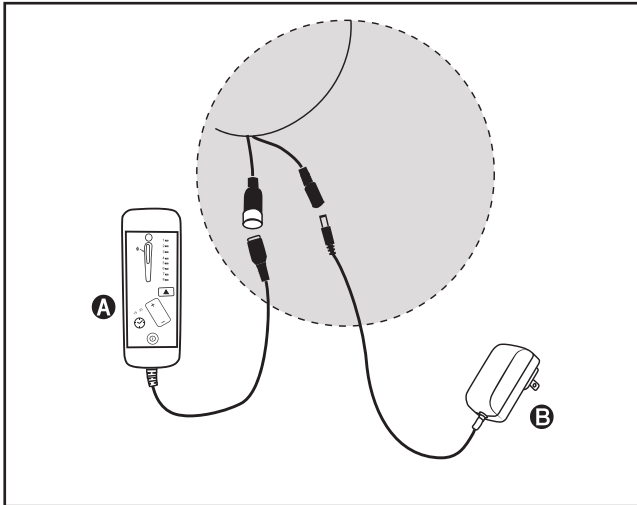

01 Manual Recliner

Please check if your wires are complete first,
There is a red wire, a white wire, and two black wires on the backrest.
There is a red wire and a white wire on the seat.

How To Connect:

1. Connect the red wire (backrest) to the red wire (seat).
2. Connect the white wire (backrest) to the white wire (seat).
3. Connect the black thick wire to the remote control.
4. Connect the black thin wire to the power cord.

Manual controller function manual

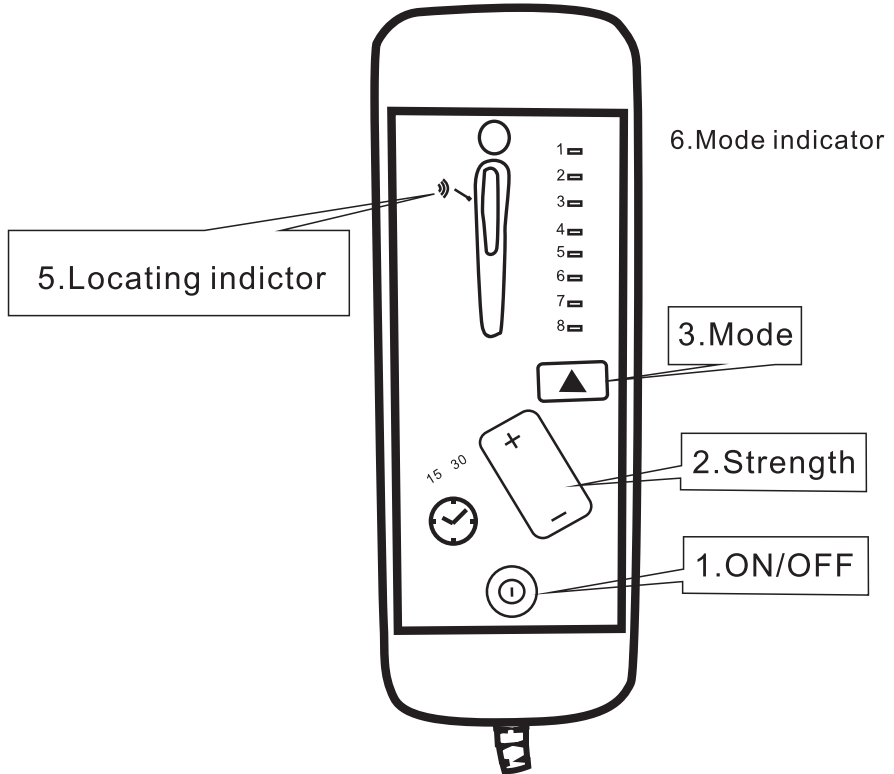

I 、 Specifications of power adapter

Power on in standby state. The user can realize the function through the hand controller control

Input :AC 100-240V, 50Hz/60HZ; Output: DC12V. 1A.

II 、 Function details

1. Click the switch machine

2. Press "+" to strengthen the vibration, and press "-" to weaken the intensity

3. Click on 8 modes to rotate

4. Click the timing switch

5. Locating indicator

6. Mode indicator

III、Product features

1. 1 road motor vibration

2. 8 kinds of motor vibration mode (the default boot mode 1)

3. 5 gear motor vibration intensity adjustment + / - (the default boot file 4)

4. the default regular shutdown time 15 min

USAGE

Leave
enough space
for reclining back

45cm
←→

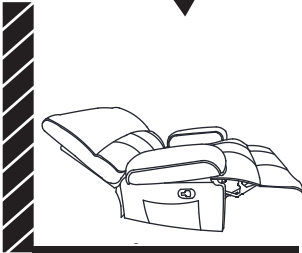
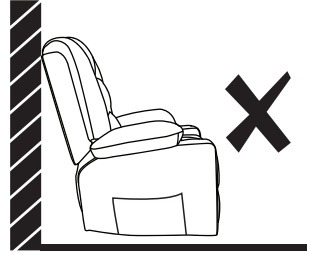
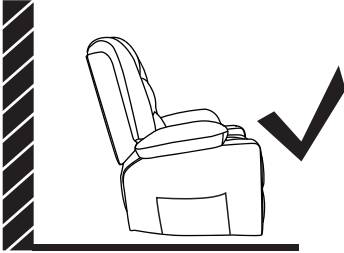

The recliner should be placed 45cm away from the wall, and the reclining function can be used normally.

PROPER USAGE

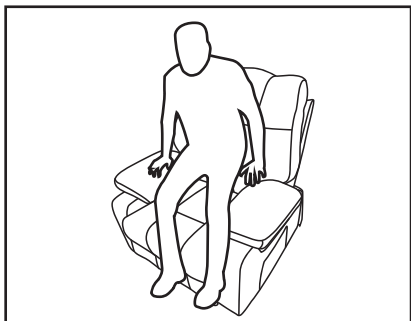

01 Steps to safely stand up from your Recliner Chair

1. Store the remote control safely in the side pocket of the seat
2. Place your feet firmly on the ground
3. Distribute the weight of the chair evenly between the arms
4. Stand up slowly from an upright position

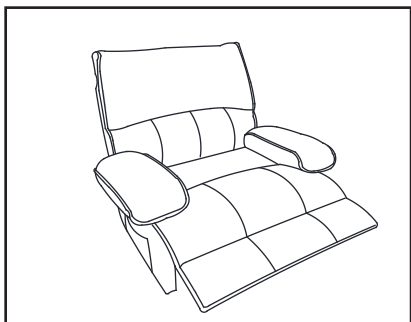

02 *Remember to store remote control safely in the side pocket when it is not in use.

*Fabrics will fade or discolor in direct sunlight, please minimize direct sunlight to extend the life of the furniture.

IMPROPER USAGE

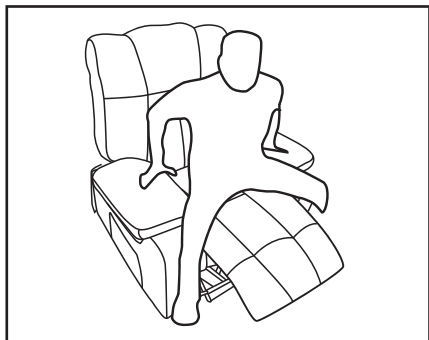

01 DO NOT
stand up when the footrest
is in the upright position.

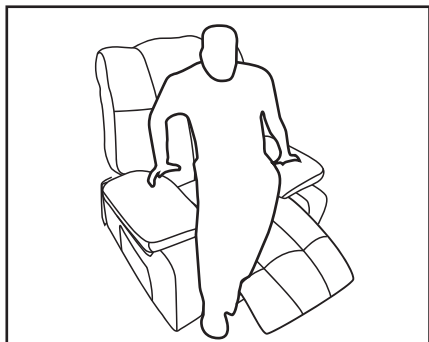

02 DO NOT
stand up from your recliner chair
with uneven weight.

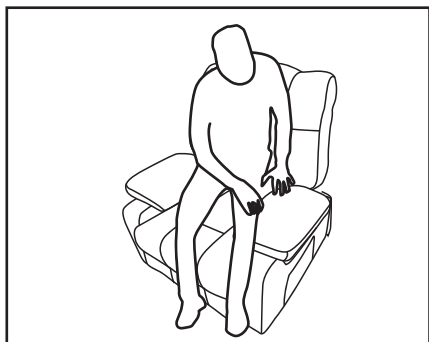

03 DO NOT
stand up from your recliner chair
with only one arm.

IMPROPER USAGE

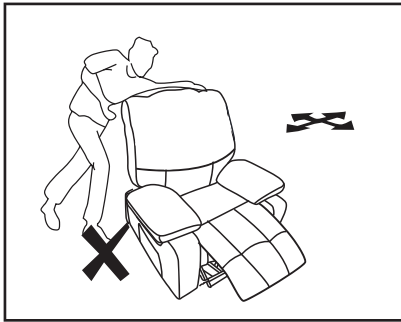

04 Please handle with care as the product contains moving parts.

* Only move the recliner when it is in the 'upright' or 'closed' position. Never attempt to move the recliner when it is in any of the reclining positions. Always use the arms to move the Recliner-DO NOT use the backrest or backrest ear parts.

WARRANTY

So glad you have completed the assembly and can enjoy it. If you are satisfied with our products, thank you for showing your favored massage recliner to your around.

Our products come with a 2-month warranty, you can feel free to contact us at any time.

AFTER-SALE POLICY

1.For return reason:

Wrong purchase, bought by mistake, no longer needed, doesn't meet expectation, a size smaller than expectation, customer need to cover the return shipping fee.

2.For cancel order:

Customer needs to pay for shipping fee and carrier handle fee if the item has been shipped out. For change address: customer needs to pay for extra shippingfee and carrier handle fee if the item has been shipped out.

3.Customer Service:

Any problem with the product or shipping issue, please feel free to contac us, we will try our best to serve and help.

Dear Customer,

Thank you for choosing us.

For safe use, please read this manual before installation, and keep it for after use. Please feel free to email us if you have any concerns about our products. We'll reply within 24 hours.

The following are the things you need to pay attention to so that we can provide you with services when you encounter problems during the installation and use of the product:

- When the product is damaged due to courier problems, please contact our customer service in time for verification.
- We will rectify the issue as soon as possible;
- We provide a 7-day no-reason return service (note that the returned product will not affect the secondary sales);

We offer product explanations, installation instructions, product maintenance and maintenance methods.

If you feel satisfied with our product and service,

- Please set our store as your favorites;
- Please recommend our products to your friends;
- Please and leave us your purchase experience in our store or product page.

Feedback or reviews from you will greatly help us offer better services to players around the world.

Best regards

Avoid using sharp objects such as a knife to cut open packing as you may accidentally damage the upholstery.
