

End Table with Storage

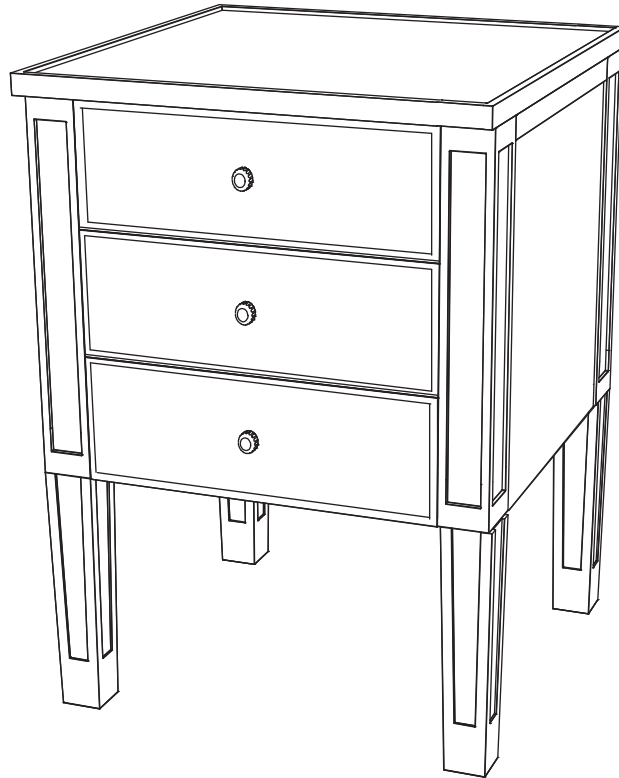

THANK YOU FOR YOUR ORDER!

ENCLOSED PLEASE FIND A POLISHING CLOTH FOR YOUR USE TO CLEAN THE MIRROR OF THIS PRODUCT.







PLEASE ALSO CALL US IF YOU HAVE ANY QUESTIONS.

ASSEMBLY INSTRUCTIONS

We have designed our furniture with you , the customer in mind . Our clear , easy to follow , step by step instructions will guide you through the project from start to finish .

Feel confident that this will be a fun and rewarding project . The final product will be a quality piece of furniture that will go together smoothly and give years of enjoyment .

Hardware List

A 	B 	C 	D 
Bolt (8pcs)	Allen wrench (1pc)	Washer (8pcs)	Screw (3pcs)
E 	F 		
Knob (3pcs)	Polishing cloth (1pc)		

Panel List

①



Top panel (1pc)

②



Leg (4pcs)

Step 1

Assemble face down on carpet or soft surface.

1. Remove drawers from top panel **1**.
2. Connect legs **2** to top panel **1** as shown using bolts (A), washers (C) and allen wrench (B).

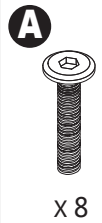
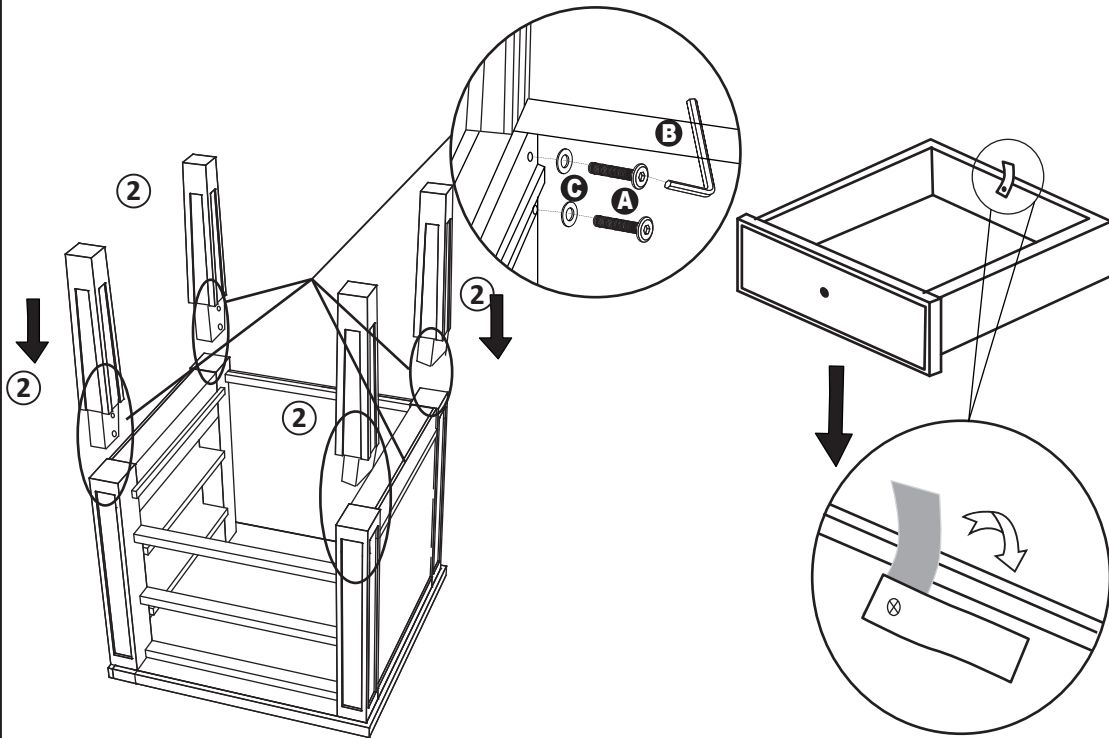

Step 2

1. Remove knob (I) from inside of drawer to outside of drawer using a hand held screwdriver. Screw (H) goes on inside of drawer.

