











Examine all packaging material for small parts that may have come loose during shipment. Periodic checks are recommended to insure that all components are in proper position, tight and free from damage. Keep this assembly instruction for future reference. Adult assembly is required.

CODE	QTY	HARDWARE
1	4	1/4" x 3"L Allen Bolts 
2	4	1/4" x 2-3/8"L Allen Bolts 
3	3	1/4" x 2"L Allen Bolts 
4	4	1/4" Lock Washers 
5	8	Ø4 x 35mm Wood Screws 
6	1	4mm Allen Wrench 
7	12	Ø10 x 50Lmm Wood Dowels 

CODE	QTY	COMPONENTS	CODE	QTY	COMPONENTS
A	2	Side Panels 	B	1	Back Panel 
C	2	Mattress Rails 	D	1	Slat Set 
E	1	Support Rail 	F	3	Support Legs 

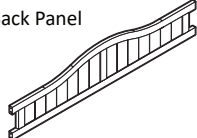
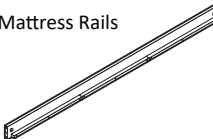
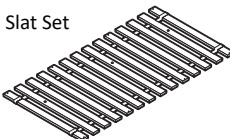
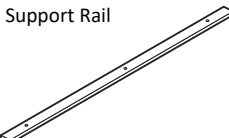
WARNING

- Do not let any sharp objects touch or rub the surface of the product.
- When assembling, do not let children play around the working area.
- Please confirm all parts are correct before starting the assembly process.
- Do not tighten all bolts and screws completely until the entire unit has been assembled and set up.
- Be careful if using power tools as they can over tighten screws and strip threads.

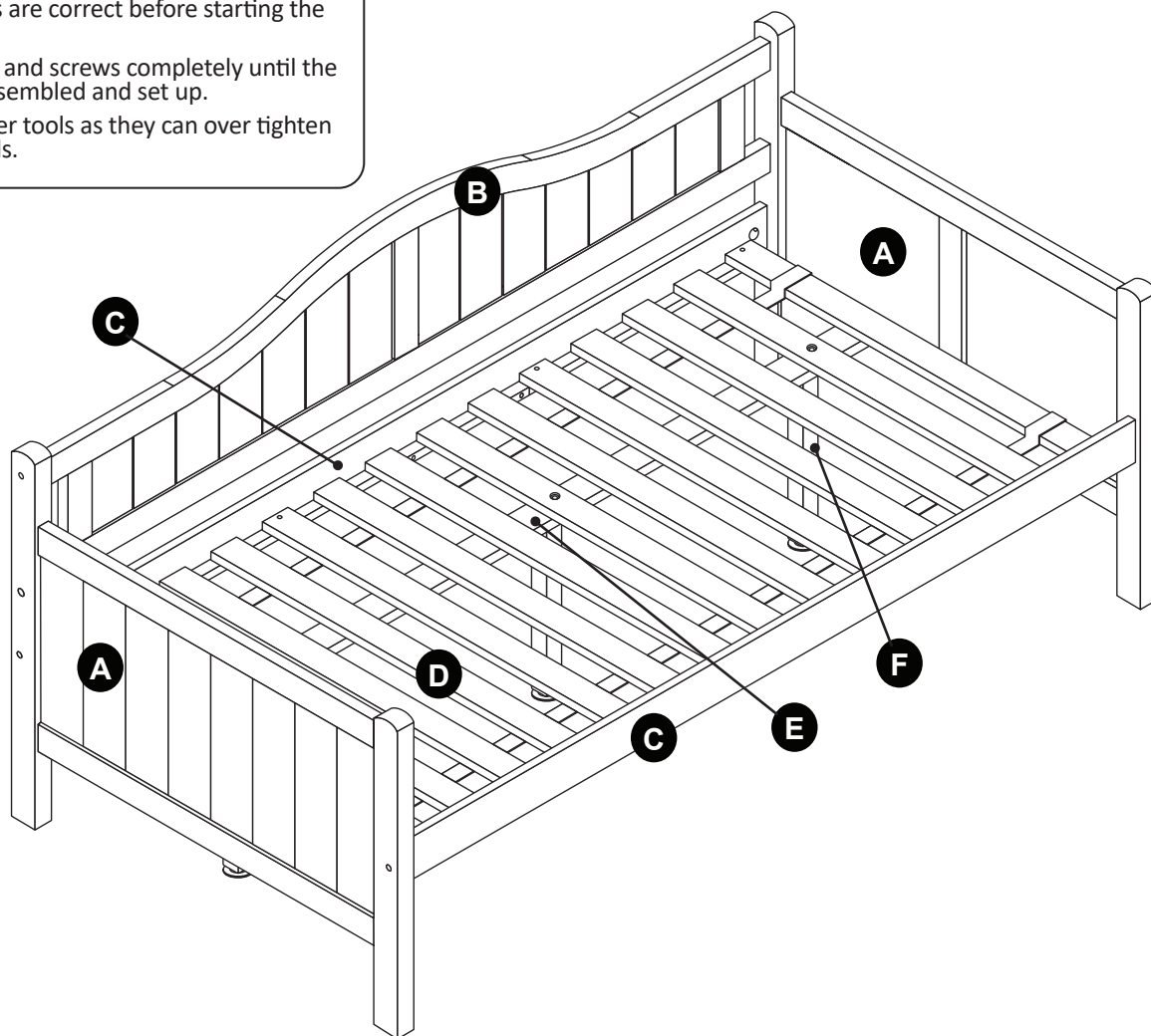

CARE & MAINTENANCE: The touch of a soft cloth is all the maintenance the finish will ever need. Please do not use harsh or abrasive cleaners for polishing, as they may cause damage to the finish. Periodic checks are recommended to make sure that all hardware is securely tightened.

FIGURE 1

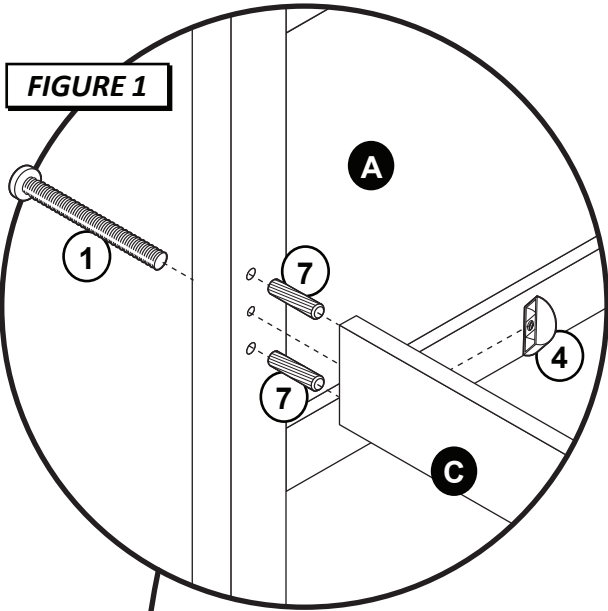

STEP 1 - Figure 1

Begin assembly by attaching Mattress Rails (C) to Side Panel (A) using 1 Lock Washer (4), 2 Wood Dowels (7) and 1 Allen Bolt (1) per rail.

FIGURE 2

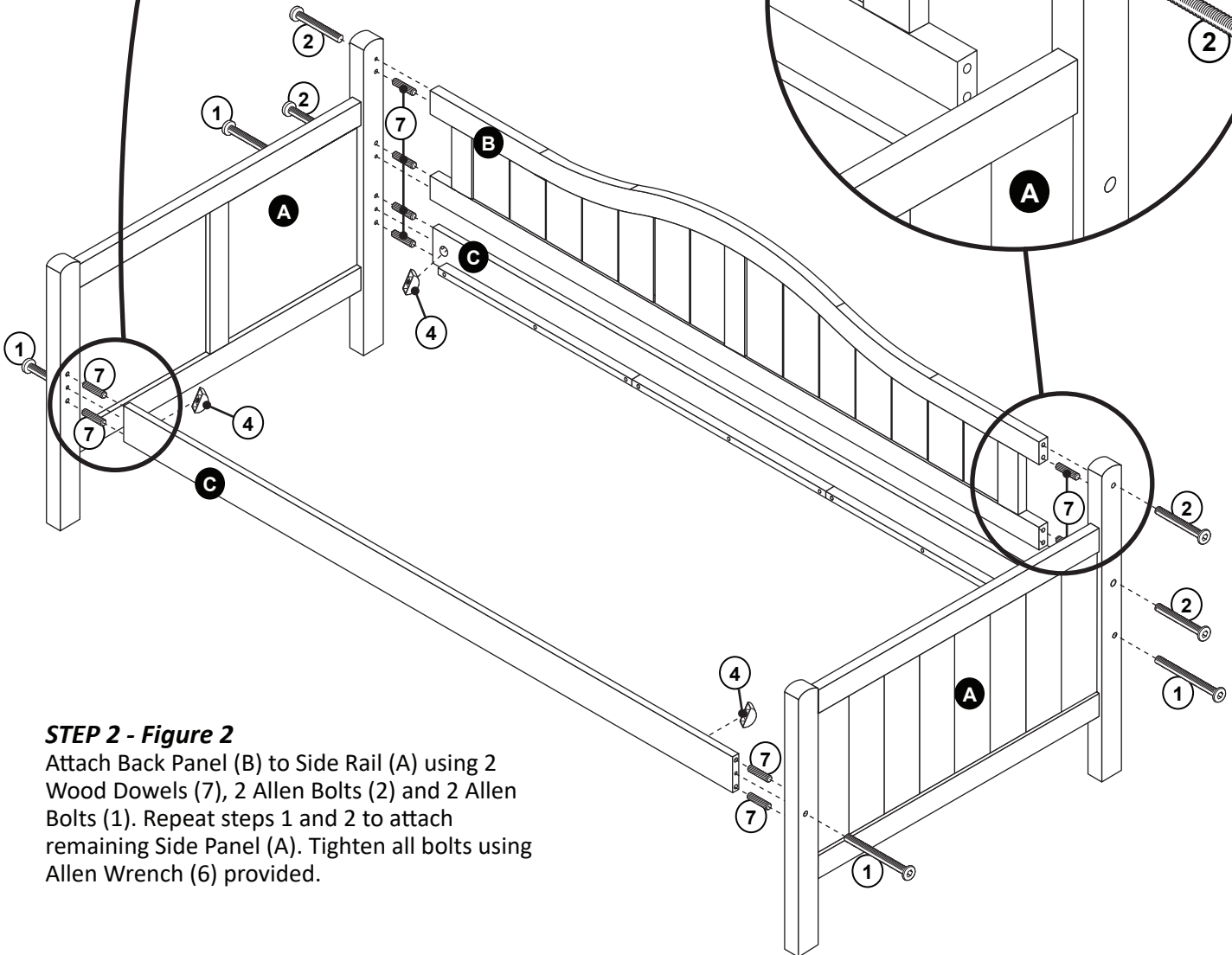
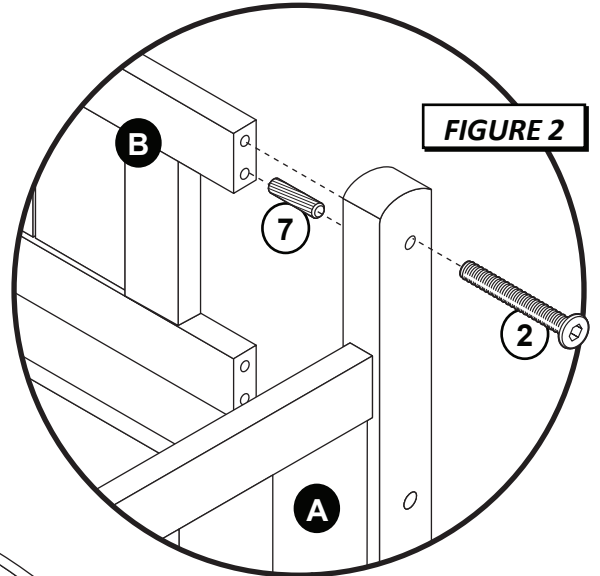

STEP 2 - Figure 2

Attach Back Panel (B) to Side Rail (A) using 2 Wood Dowels (7), 2 Allen Bolts (2) and 2 Allen Bolts (1). Repeat steps 1 and 2 to attach remaining Side Panel (A). Tighten all bolts using Allen Wrench (6) provided.

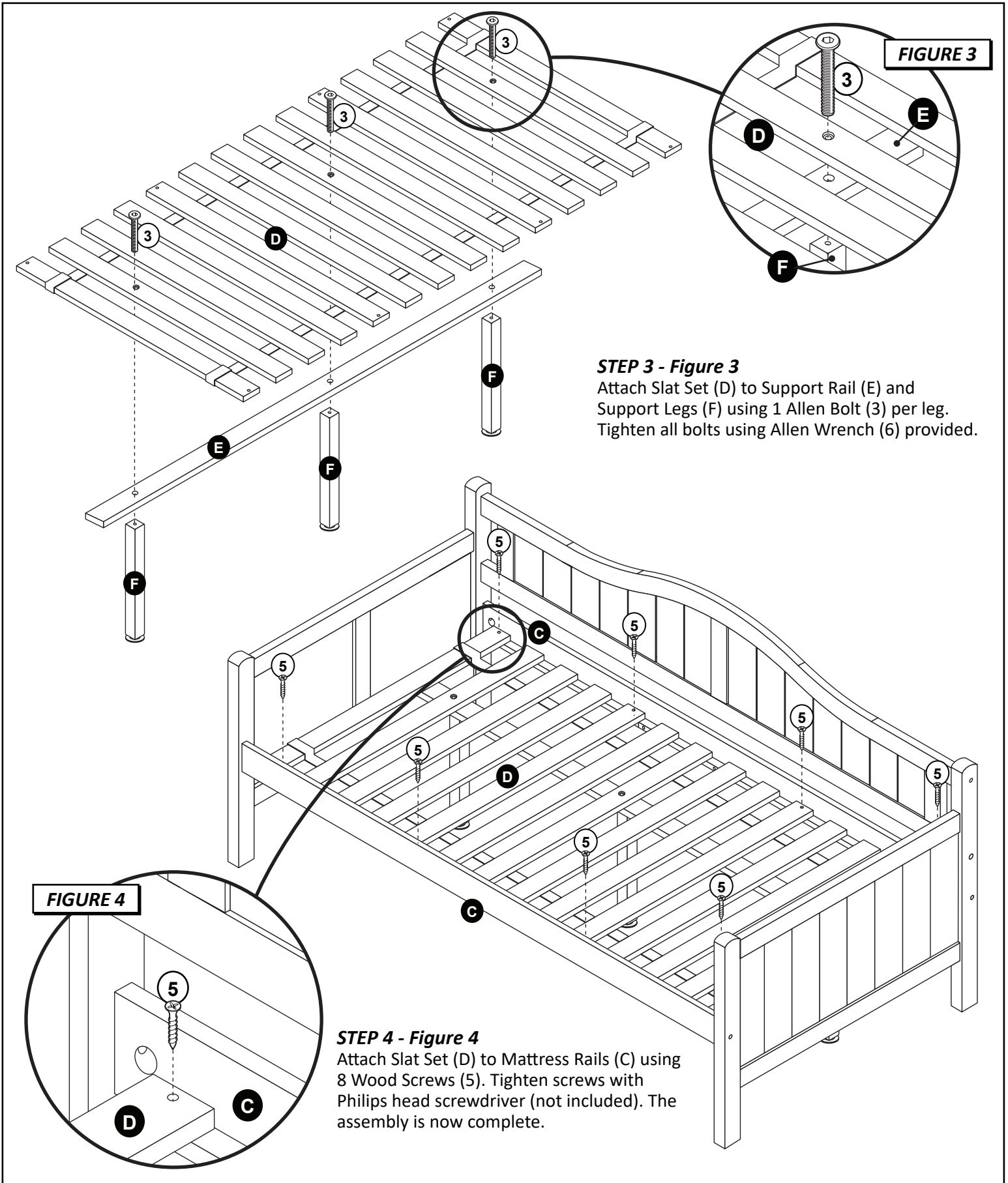

STEP 3 - Figure 3
Attach Slat Set (D) to Support Rail (E) and Support Legs (F) using 1 Allen Bolt (3) per leg. Tighten all bolts using Allen Wrench (6) provided.

STEP 4 - Figure 4
Attach Slat Set (D) to Mattress Rails (C) using 8 Wood Screws (5). Tighten screws with Phillips head screwdriver (not included). The assembly is now complete.

CARE & MAINTENANCE: The touch of a soft cloth is all the maintenance the finish will ever need. Please do not use harsh or abrasive cleaners for polishing, as they may cause damage to the finish. Periodic checks are recommended to make sure that all hardware is securely tightened.