























# Assembly Instructions

Caution : You must read this before you proceed

## Care & Maintenance

- 

  - Not for commercial use. For residential use only.
- 

  - Furniture may scratch floors. We recommend using furniture pads to protect your floors.
- 

  - Do not put hot items directly on furniture surface.
- 

  - Do not clean furniture with harsh cleansers or polish.
- 

  - Do not place furniture under direct sunlight.
- 

  - Do not place furniture near heating or cooling vents.
- 

  - Do not write on furniture without a padded barrier to protect the surface.
- 

  - Do not place furniture outside . For indoor use only.
- 

  - Stains may be removed with mild soap solution and damp cloth.
- 

  - Children should not climb or jump on the furniture.
- 

  - Dust and pick-up spills using a clean, non-colored, lint-free cloth.

Please look in Seat frame for hardware packs and legs.

Sets often ship in multiple boxes and may arrive a day or two apart.

# QUEEN BED

## N770P389795-N770P389796



### WARNING !

#### STRANGGULATION HAZARD

NEVER place bed near windows where cords from blinds or drapes may strangle a child.

NEVER suspend strings over bed.

NEVER place items with a string, cord, or ribbon, such as hood strings or pacifier cords, around a child's neck. These items may catch on bed parts.

ALWAYS follow assembly instructions.

Not intended for children under the age of six. **INFANTS HAVE DIED FROM BECOMING ENTRAPPED IN BEDS.** Openings in and between bed parts can entrap the neck and head of a small child.

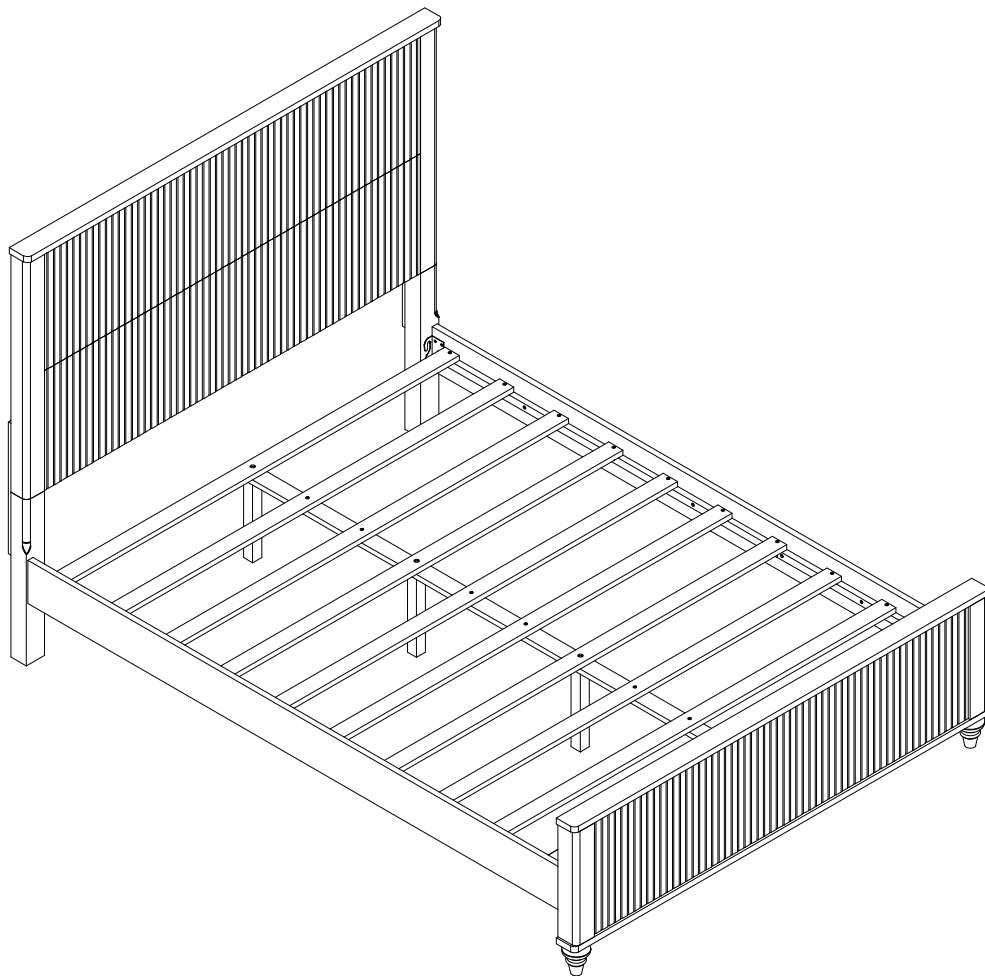

NEVER use bed for child under the age of six.

The mattress must be appropriately sized for the bed. If the mattress is undersized dangerous gaps can exist and a person can become entrapped or entangled in the frame and suffocate





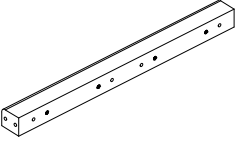
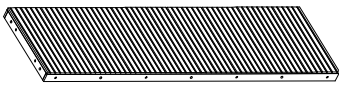
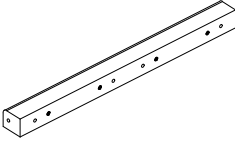
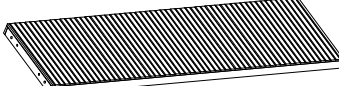
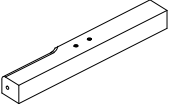
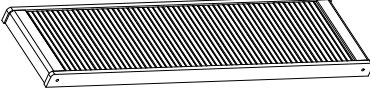
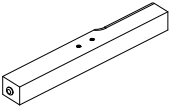

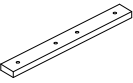
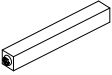
**CAUTION:** This Queen Bed is NOT a TOY.  
Keep your child / children at bay in the process of assembly.  
For turning the Queen Bed and to prevent damage to the Queen Bed.  
02 persons may be needed to execute this action.

N770P389795-96  
**PARTS LIST**  
 N770P389795

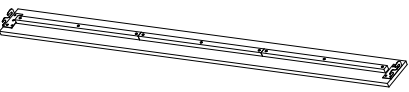

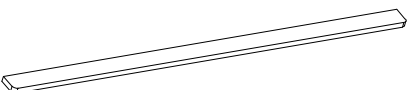



①	Leg above right Headboard 	1PC	⑦	Headboard 1 	1PC
②	Leg above left Headboard 	1PC	⑧	Headboard 2 	1PC
③	Leg below right Headboard 	1PC	⑩	Footboard 	1PC
④	Leg below left Headboard 	1PC	⑪	Leg footboard 	2PCS
⑤	Headboard back bar 1 	2PCS	⑬	Middle leg 	4PCS

**PARTS LIST**  
 N770P389796

⑨	Side rails 	2PCS	⑭	Slats 1 	4PCS
⑥	Top cover Headboard 	1PC	⑮	Slats 2 	6PCS
⑫	Skirt support 	1PC			

## HARDWARE LIST

### N770P389795

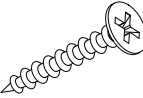
<b>(A)</b>	Bolt 1/4*30MM		32PCS +1	<b>(E)</b>	Iron dowel Ø 12 * 90MM		2PCS +1
<b>(B)</b>	Wooden dowel Ø 10 * 30MM		18PCS +1	<b>(F)</b>	Flat washer 2*8*15MM		32PCS +1
<b>(C)</b>	Allen wrench L58MM		2PCS	<b>(G)</b>	Bolt 1/4*55MM		4PCS +1
<b>(D)</b>	Pipe bolts 1/4*15MM		4PCS +1	<b>(H)</b>	Vis flat head 4*30MM		26PCS +1

ASSEMBLY TOOLS REQUIRED (NOT INCLUDED)

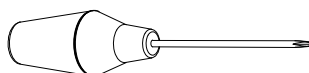

# PRODUCT DETAILS

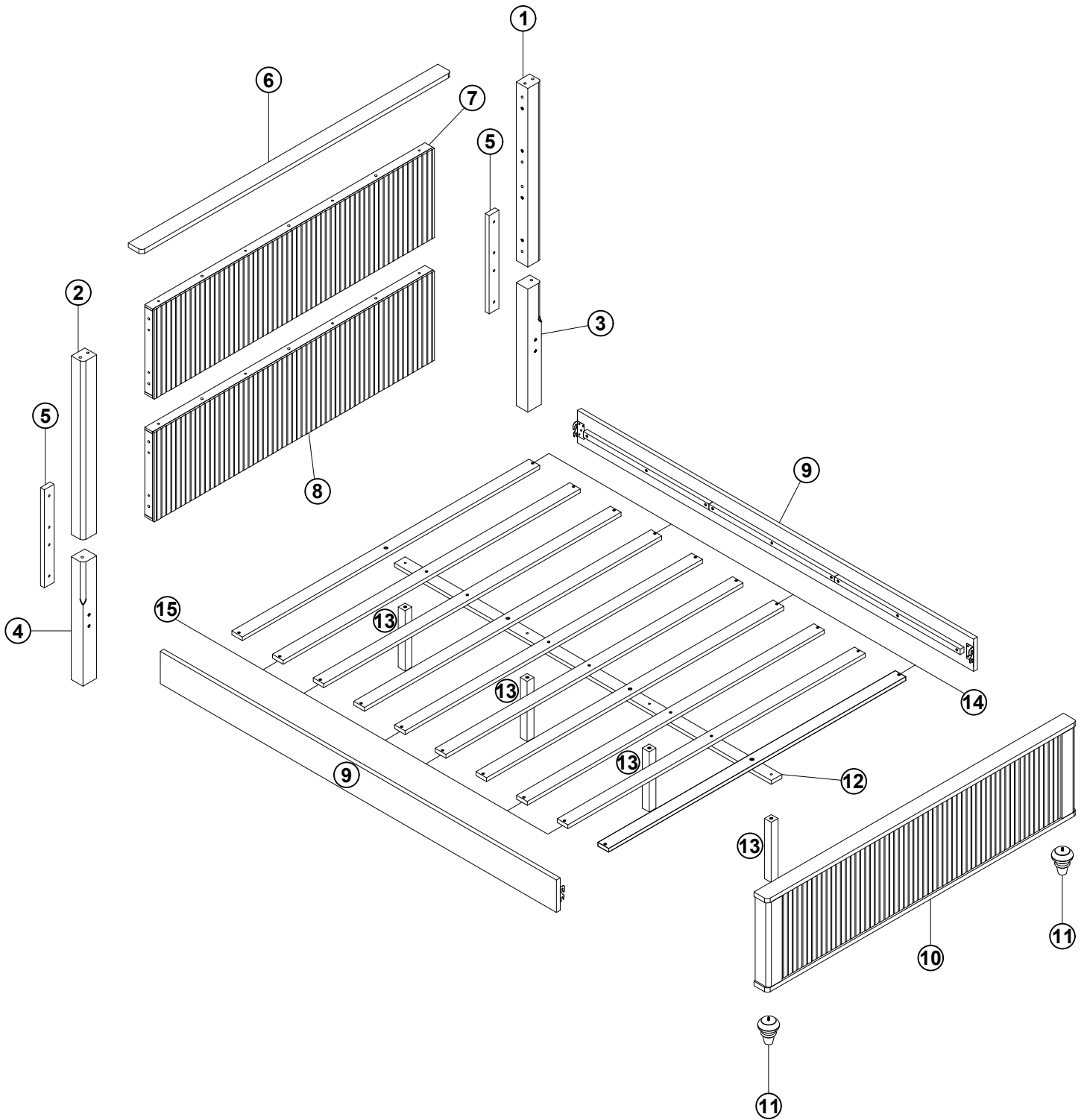

# ASSEMBLY STEPS

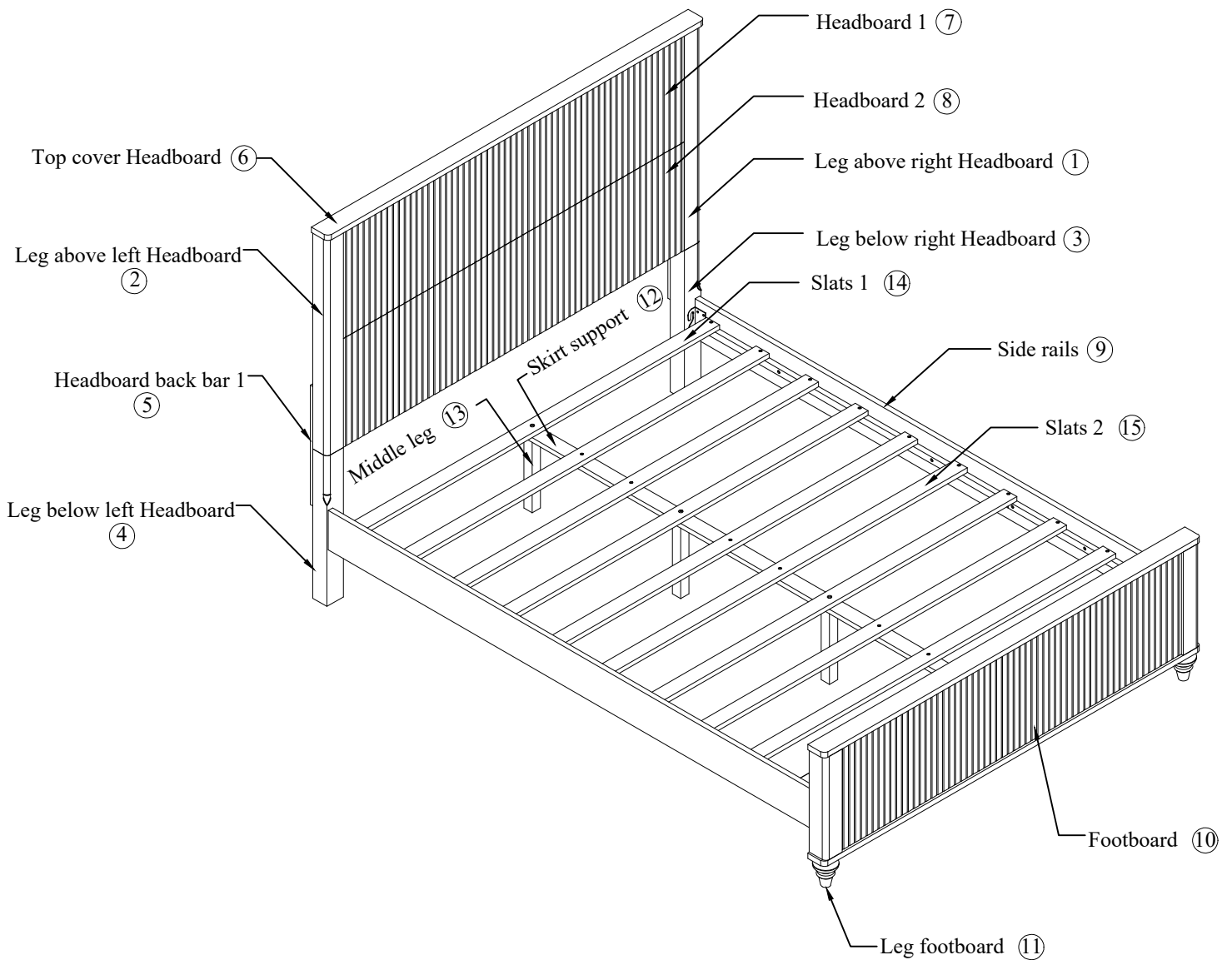

This bed has multiple parts and may require up to some 30 minutes to assemble. To give you an overview of the upholstered bed parts, the above picture is to help you put the various parts into perspective. please read through the instructions below to familiarise yourself with the parts and steps before assembly.

# ASSEMBLY PREPARATION

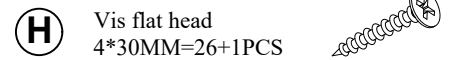
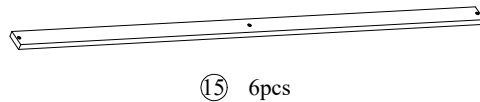
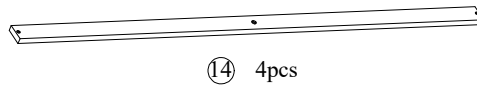
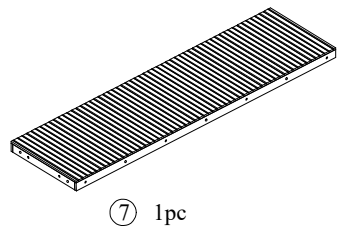
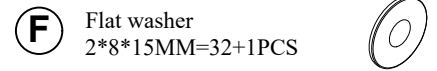
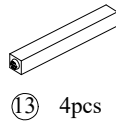
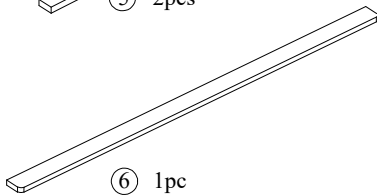
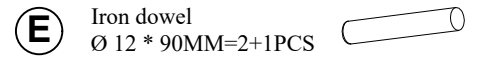
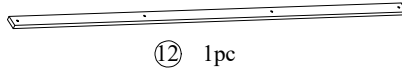
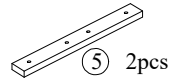
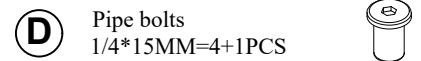
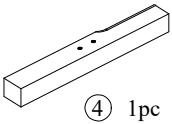
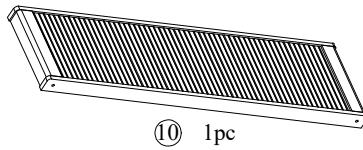
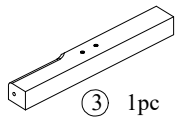
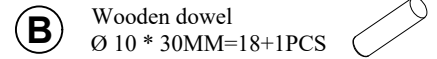
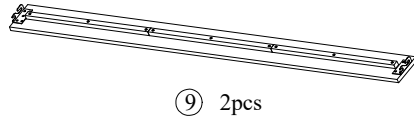
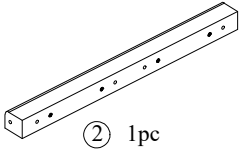
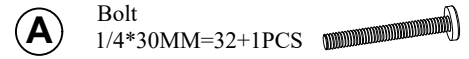
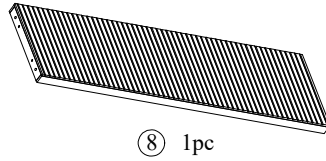
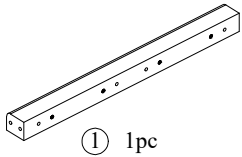

• Read instructions, cover to cover-



• Have 2 adults on hand for assembly-



• Do not assemble on flooring or carpet-



• Assemble on a clean non-marring surface (packing foam)-



• Save all packaging until finished-

STEP 1

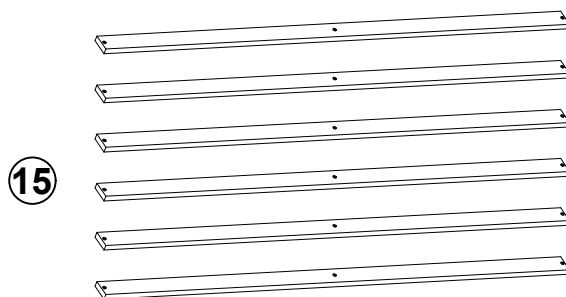
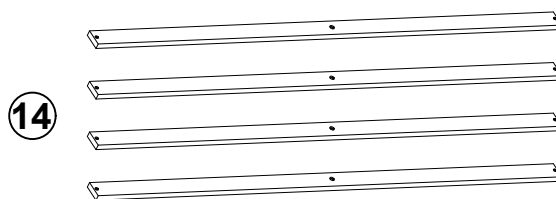
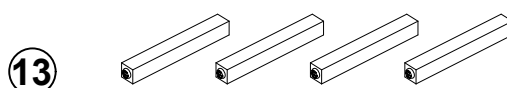
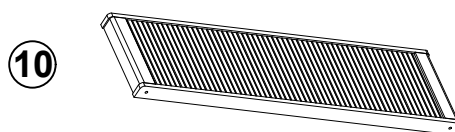
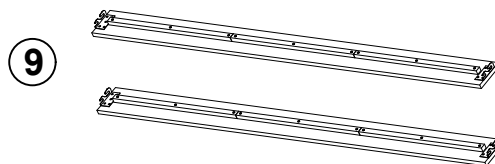
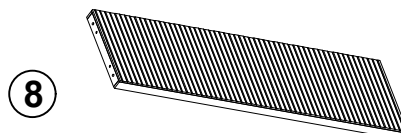
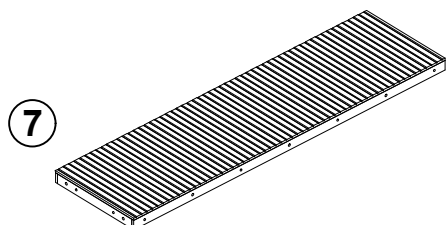
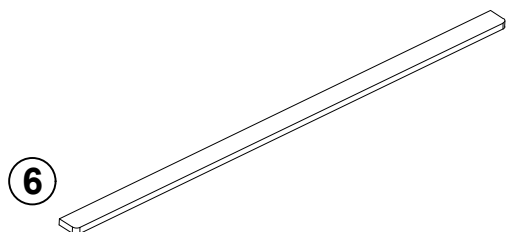
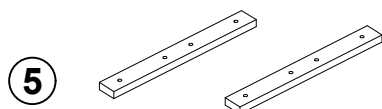
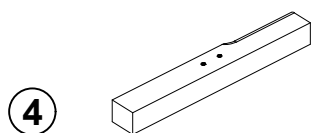
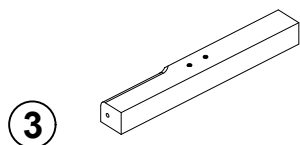
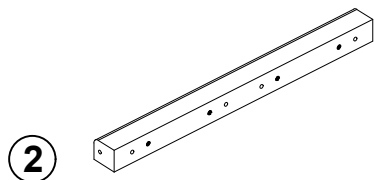
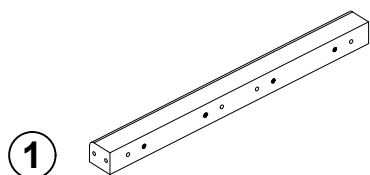

First step Unpack and place all part on a clean, non-marring surface.

STEP 2

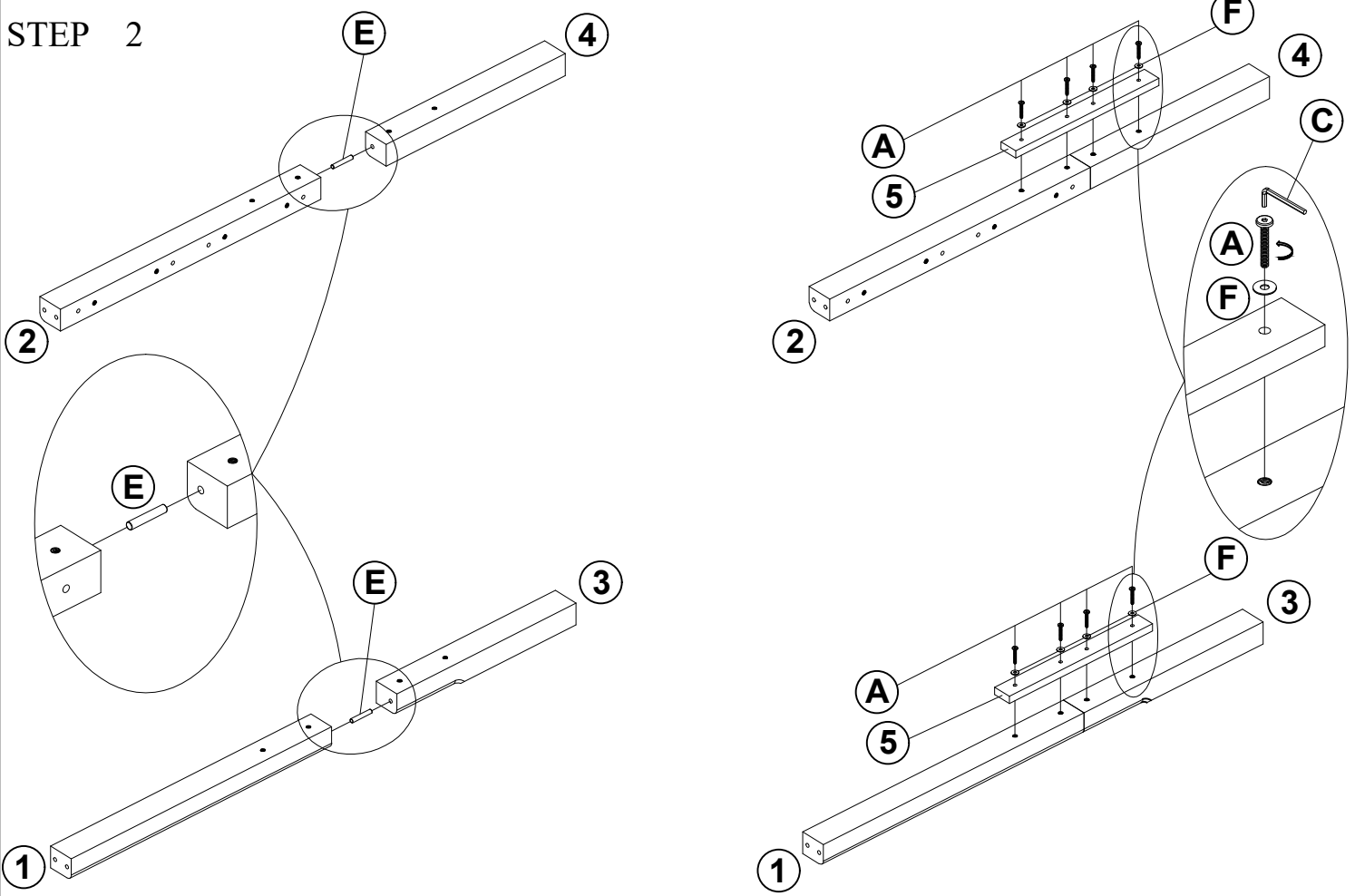

Next step is to assemble the Leg above left Headboard ② and the Leg below left Headboard ④ / assemble the Leg above right Headboard ① and the Leg above right Headboard ③ using the 12\*90mm Iron dowel ⑤ to connect, then attach the Headboard back bar 1 ⑤ using the 1/4\*30mm bolt ④ and flat washer 2\*8\*15mm ⑥.

STEP 3

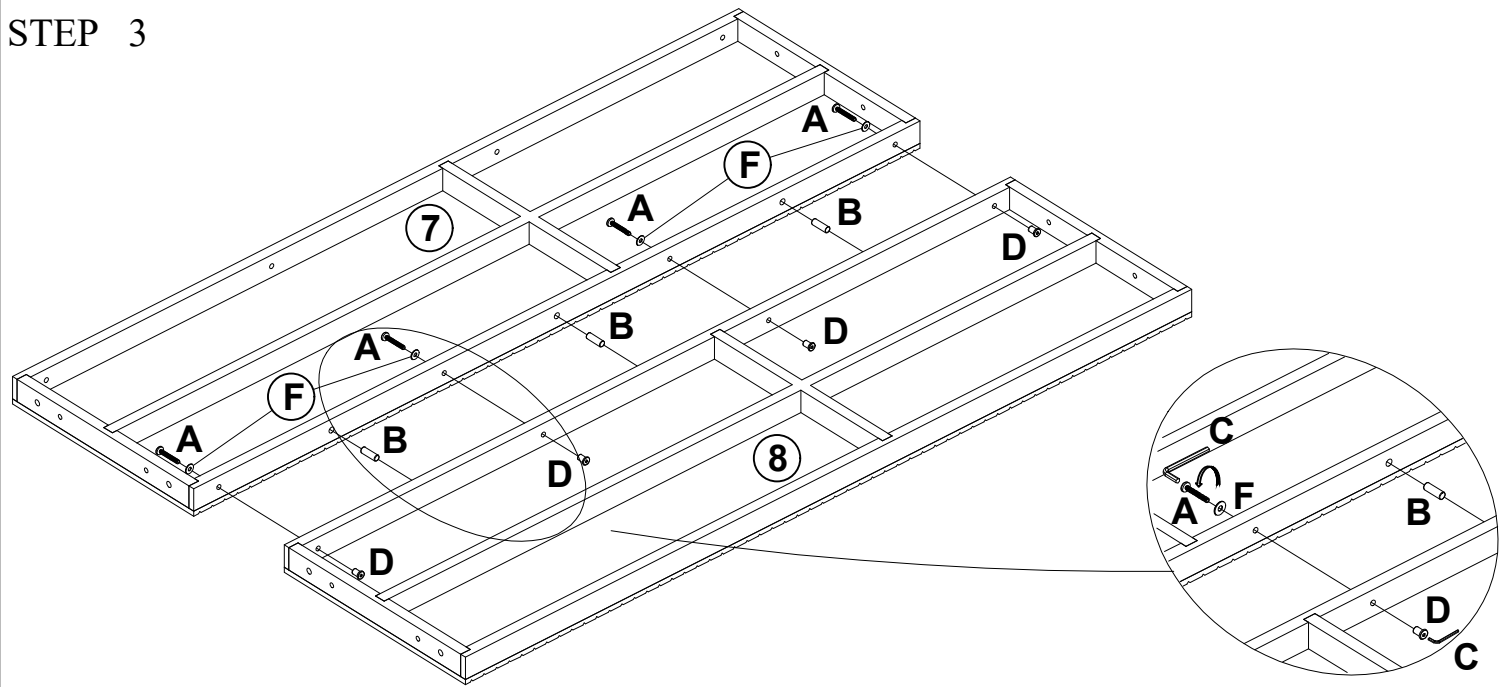

Next step: Connect the headboard 1 ⑦ to the headboard 2 ⑧ using 1/4\*30mm bolt ④ 2\*8\*15mm flat washer ⑥ Wooden dowel 8\*30mm ⑤ pipe bolts 1/4\*15mm ③ Allen wrench L58mm ② tighten.

STEP 4

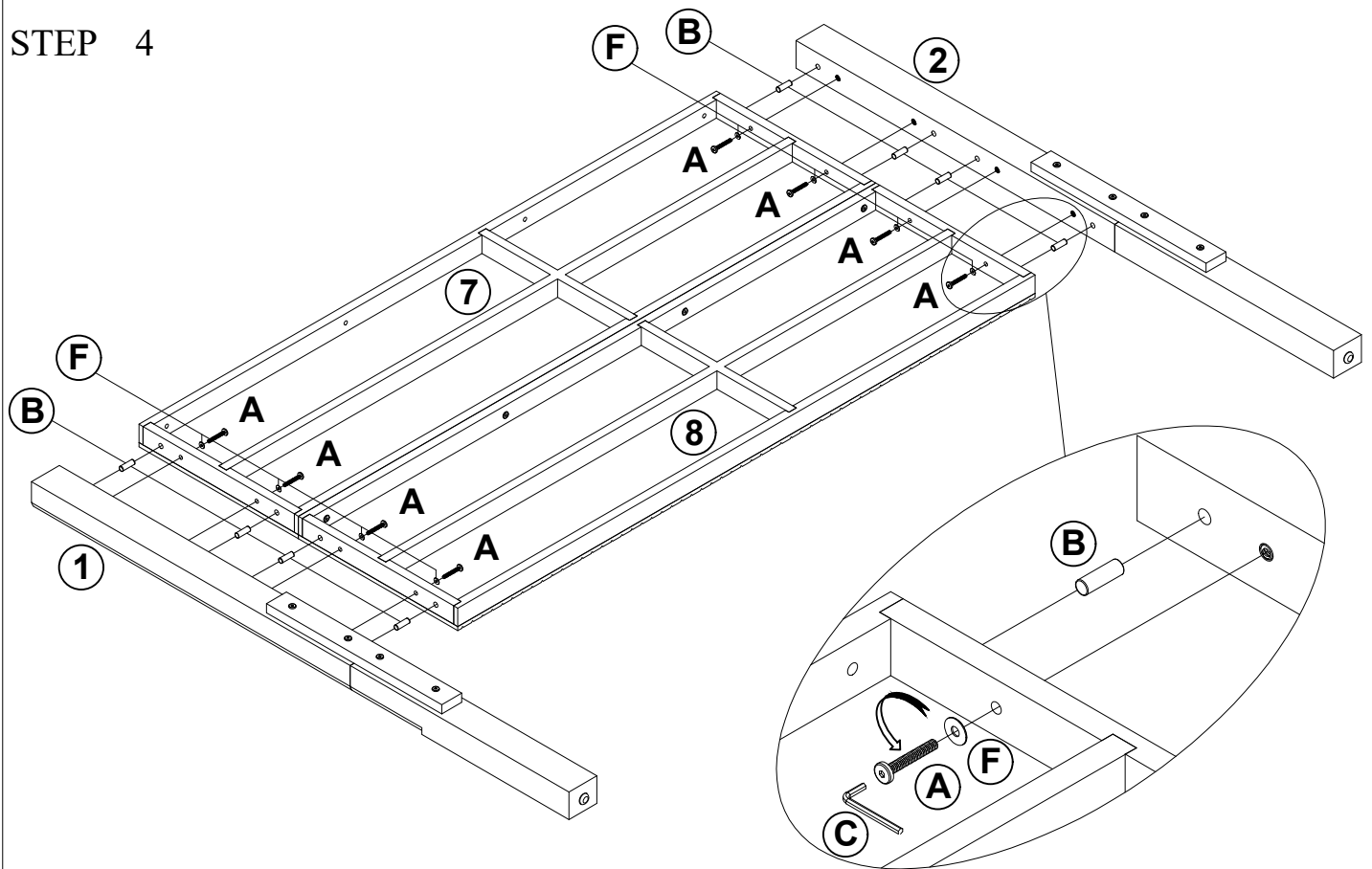

next step connect left leg ② right legs 1 headboard ⑦⑧ Wooden dowel 8\*30mm ③ bolt 1/4\*30mm ④ Flat washer 2\*8\*15mm ⑤ Allen wrench L58MM ⑥ to tighten

STEP 5

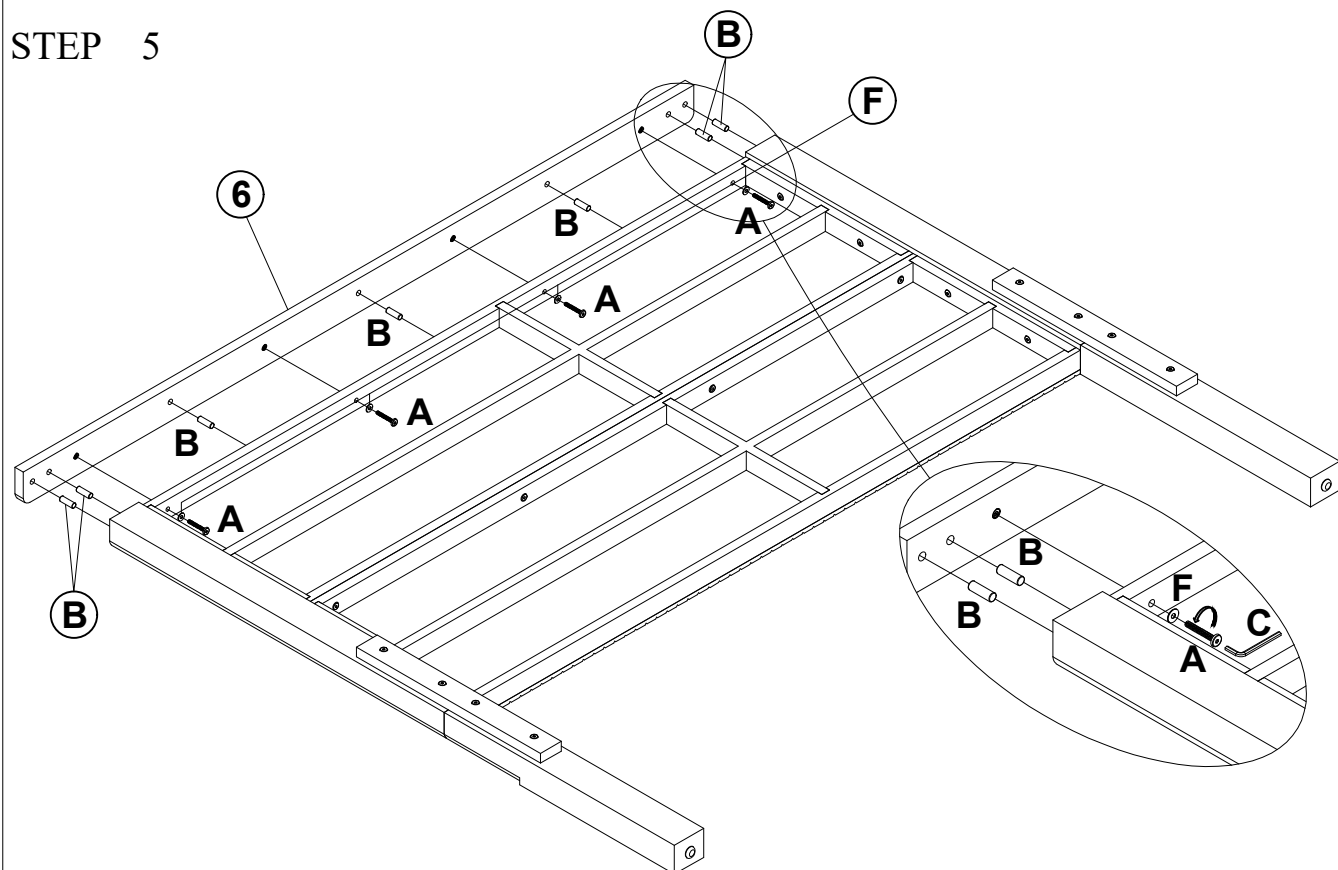

Next step assembly Top cover Headboard ⑥ in step 4 use wooden dowel Ø 10\*30mm ③ bolt 1/4\*30mm ④ flat washer 2\*8\*15mm ⑤ Allen wrench L58mm ⑥ to tighten

## STEP 6

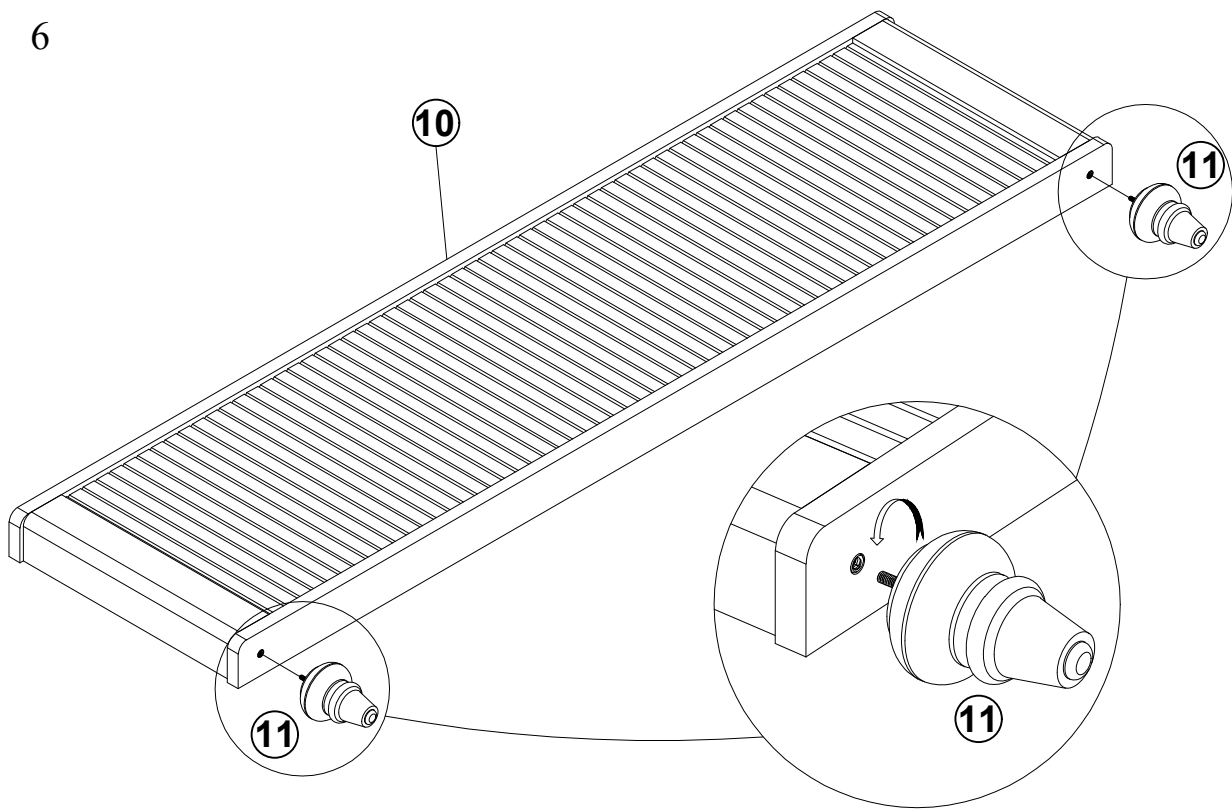

Next step is to assemble Leg footboard ⑪ into Footboard ⑩ and tighten it with your hands as shown in the illustration.

## STEP 7

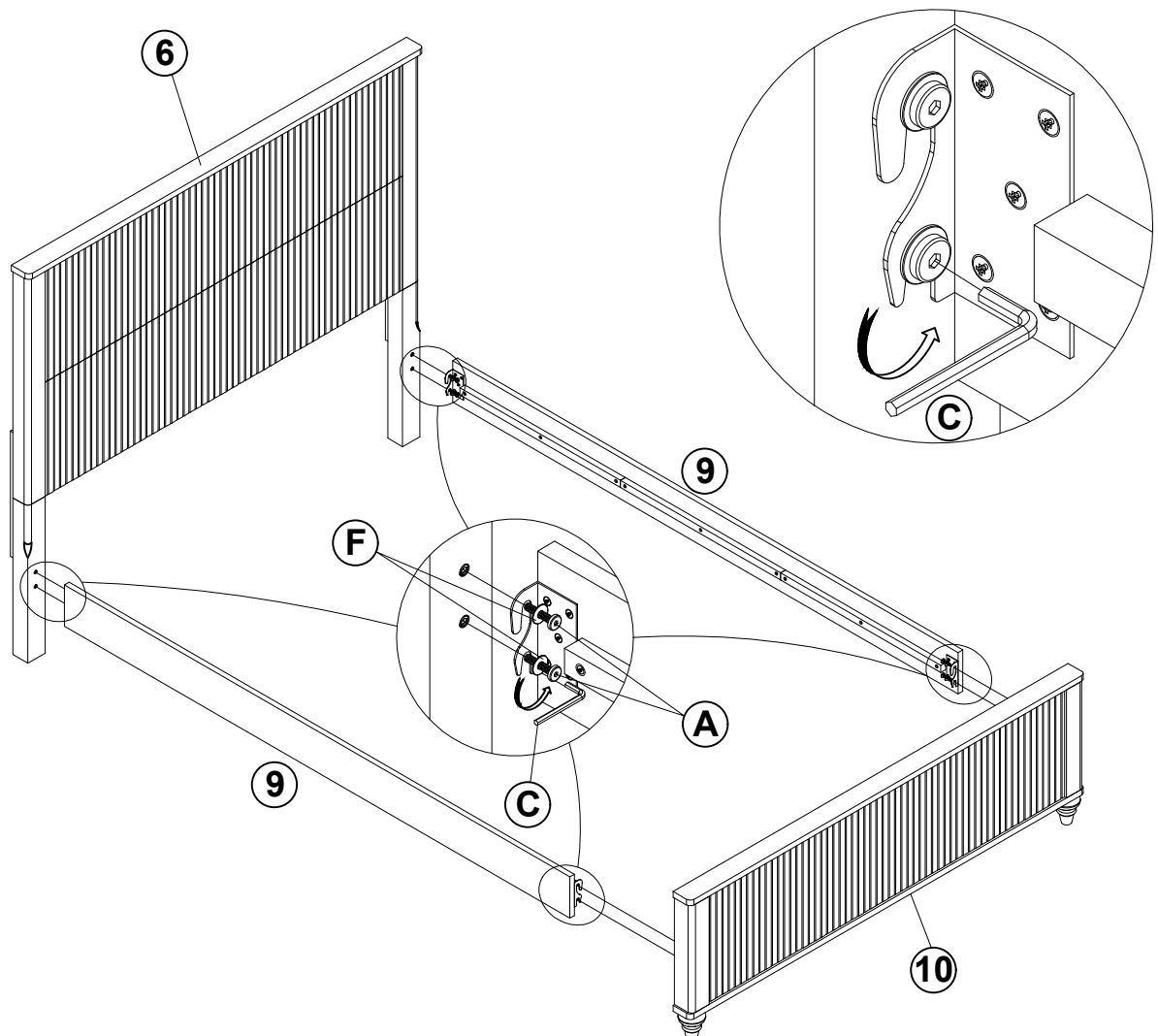

Next step is to assemble the Side rails ⑨ into the Headboard ⑧ and Footboard ⑩ use 1/4\*30mm bolt ④ 2\*8\*15mm flat washer ⑤ use Allen wrench L58mm ③ to tighten

STEP 7

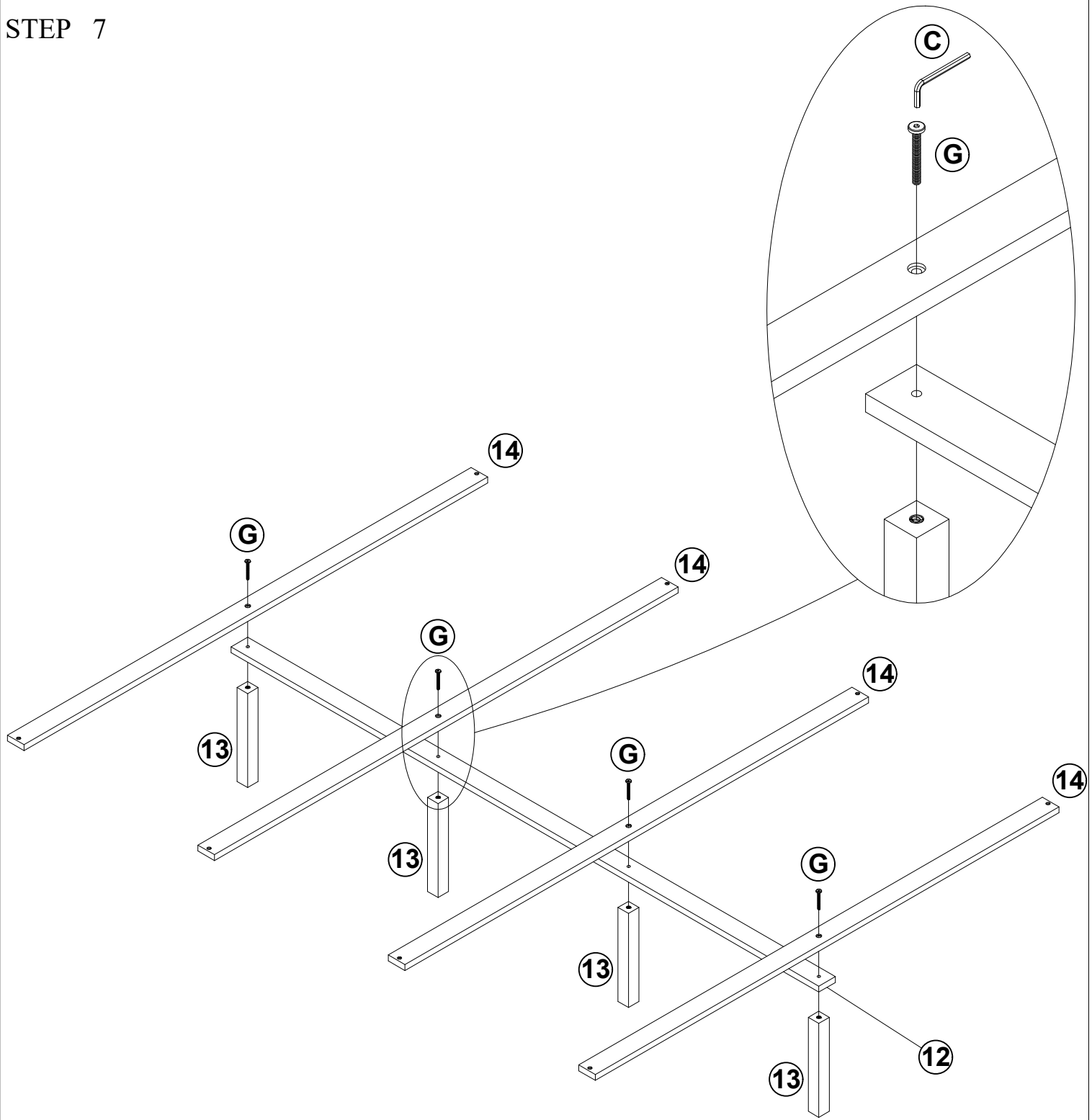

Next step: Assemble the slats (14) Skirt support (12) Middle leg (13) bolt 1/4\*55mm (G) Use an Allen wrench L58mm (C) to tighten

STEP 8

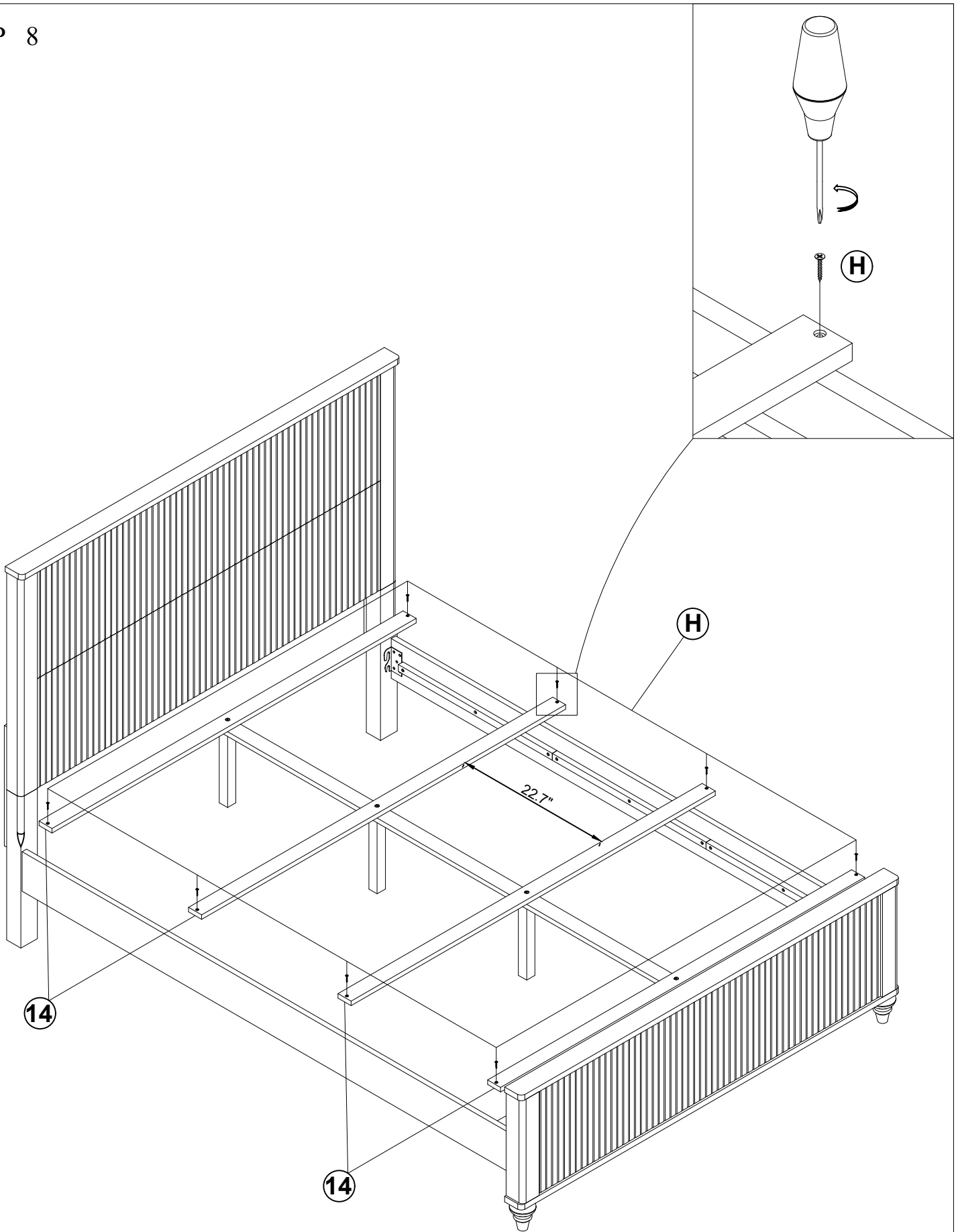

next step assemble the cluster in step 8 into the cluster in step 7 using 4\*30mm flat head **H** screw use screwdriver to tighten  
 note: distance from slats 22.7"

## STEP 9

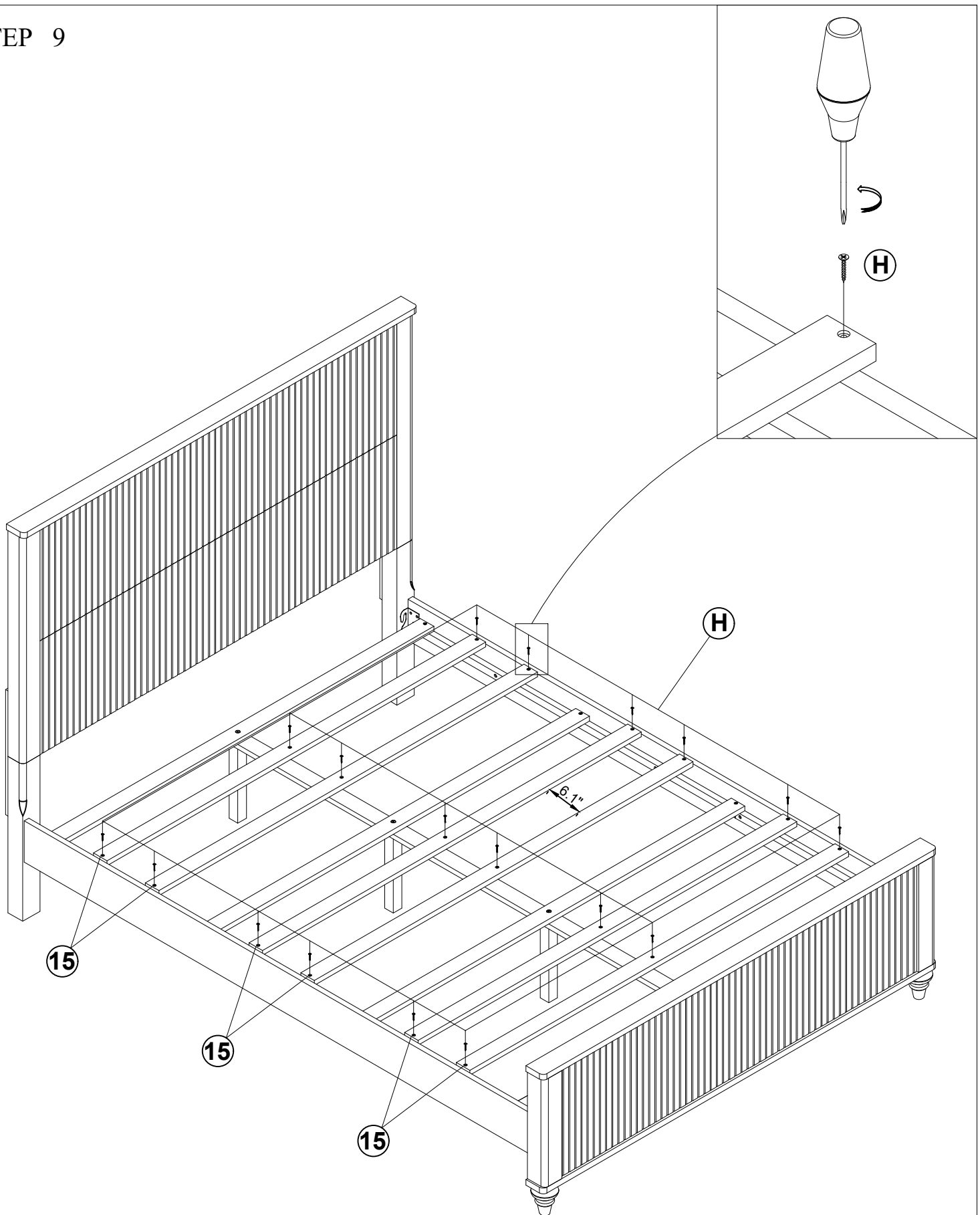

next step assemble slats ⑮ in step 9 use 4\*30mm flat head ④ screw use screwdriver to tighten  
note: slats distance 6.1"

## STEP 10

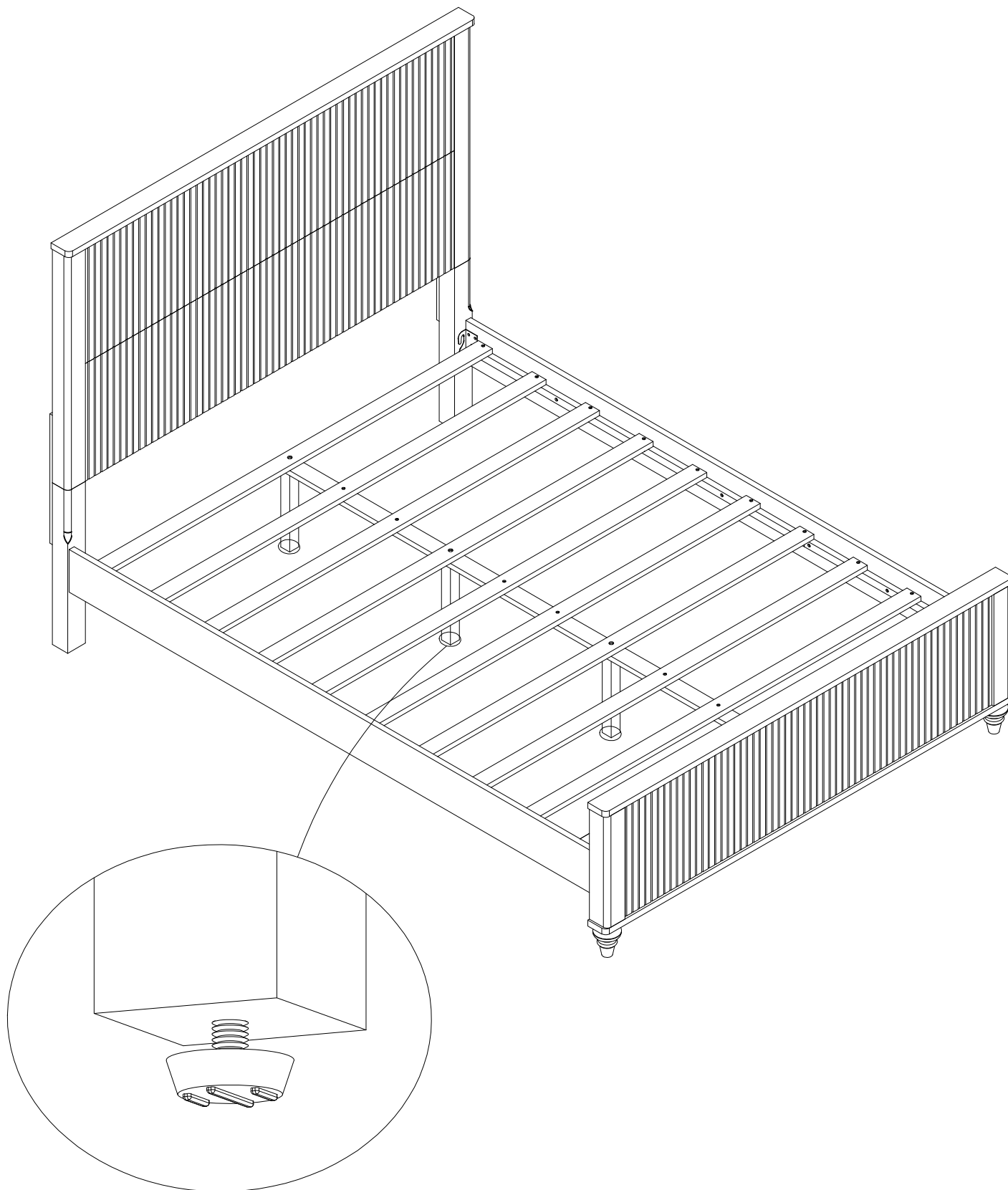

In the finishing step, we can adjust the foot support to fit the floor. See illustration.

Inspect the Bed and make sure all parts are adequately connected.

Adjust the levelers to desired height to avoid wobbles.

Your bed is ready for use.

**CARE INSTRUCTIONS:**

Hardware may loosen overtime. periodically check that all connections are tight.

Wipe with a soft, dry cloth. To protect finish, avoid the use of chemicals and household Cleaners.

## Questions & Answers about Proposition 65

- What is Proposition 65?

Proposition 65 requires businesses to provide warnings to Californians about significant exposures to chemicals that cause cancer, birth defects or other reproductive harm. These chemicals can be in the products that Californians purchase, in their homes or workplaces, or that are released into the environment. By requiring that this information be provided, Proposition 65 enables Californians to make informed decisions about their exposures to these chemicals.

Proposition 65 also prohibits California businesses from knowingly discharging significant amounts of listed chemicals into sources of drinking water.

Proposition 65 requires California to publish a list of chemicals known to cause cancer, birth defects or other reproductive harm. This list, which must be updated at least once a year, has grown to include approximately 900 chemicals since it was first published in 1987.

- What types of chemicals are on the Proposition 65 list?

The list contains a wide range of naturally occurring and synthetic chemicals that include additives or ingredients in pesticides, common household products, food, drugs, dyes, or solvents. Listed chemicals may also be used in manufacturing and construction, or they may be byproducts of chemical processes, such as motor vehicle exhaust.

- What does a warning mean?

If a warning is placed on a product label or posted or distributed at a workplace, a business, or in rental housing, the business issuing the warning is aware or believes that it is exposing individuals to one or more listed chemicals.

By law, a warning must be given for listed chemicals unless the exposure is low enough to pose no significant risk of cancer or is significantly below levels observed to cause birth defects or other reproductive harm.

- Where can I get more information on Proposition 65?

If you have specific questions on the administration or implementation of Proposition 65, you can contact OEHHA's Proposition 65 program at [P65.Questions@oehha.ca.gov](mailto:P65.Questions@oehha.ca.gov), or by phone at (916) 445-6900.