

ONE DRAWER CONSOLE TABLE

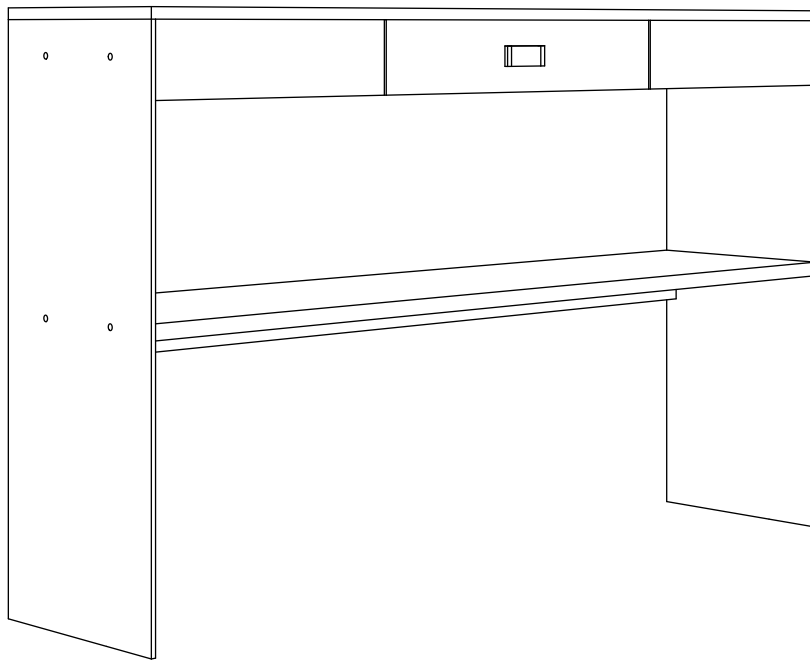







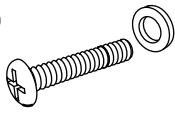

THANK YOU FOR YOUR ORDER!
ENCLOSED PLEASE FIND A POLISHING CLOTH FOR YOUR USE TO CLEAN THE GLASS
OF THIS PRODUCT.
PLEASE ALSO CALL US IF YOU HAVE ANY QUESTIONS.

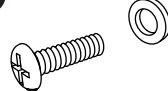

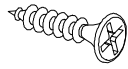
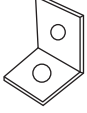
ASSEMBLY INSTRUCTIONS

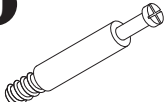
We have designed our furniture with you , the customer in mind . Our clear , easy to follow ,
step by step instructions will guide you through the project from start to finish .
Feel confident that this will be a fun and rewarding project . The final product will be a quality
piece of furniture that will go together smoothly and give years of enjoyment .

Hardware List

A 	B 	C 	D 	E 
Long screw and washer (6pcs)	Locking nut (6pcs)	Polishing cloth (1pc)	Short screw and washer (4pcs)	Cable tie (2pcs)
F 	G 	H 	I 	J 
Eyelet screw (2pcs)	Short screw (2pcs)	Bracket (2pcs)	Plastic anchor (2pcs)	Cambolt (3pcs)
K 	J 	Glue : For securing please apply to wood dowel first before inserting into panel .		
Camlock (3pcs)	Glue (1pc)			

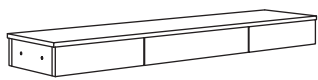
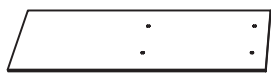
Panel List

①  Top component (1pc)	②  Side panel (2pcs)
③  Bottom panel (1pc)	④  Back panel (1pc)

Assembling the unit with camlocks and wood dowels.

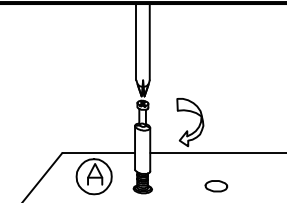
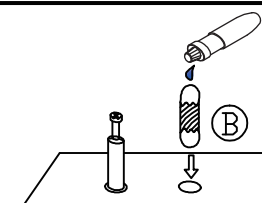
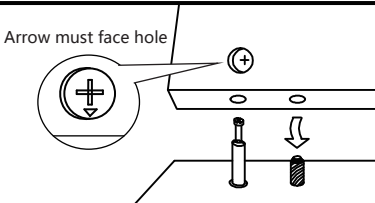
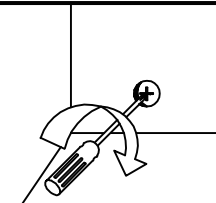
			
Gently screw cambolt into the threaded anchor.	Lightly glue one end of the wood dowel and tap halfway into hole.	Lightly glue wood dowel and connect to second panel by inserting dowels into holes.	Screw the camlock firmly into locked position.

Step 1

Place face down on carpet or soft surface.

1. Insert cambolts (J) into bottom panel ③.

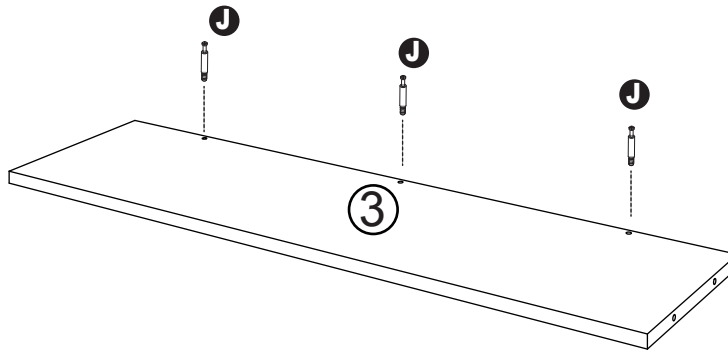

Step 2

1. Attach back panel ④ to bottom panel ③ using Camlocks (K) by gently tightening camlocks.

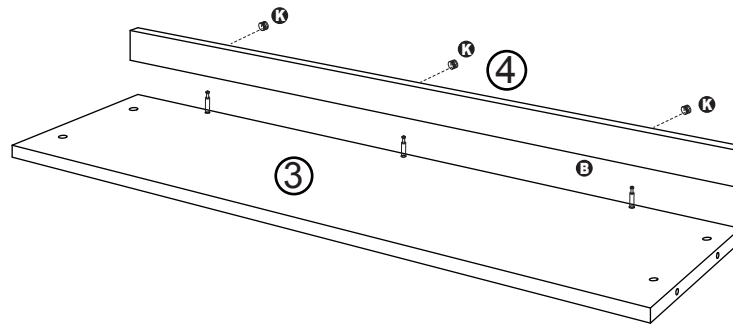

Step 3

1. Connect the side panels ② to top component ① using short screws and washers (D).

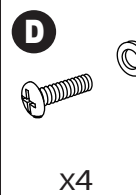
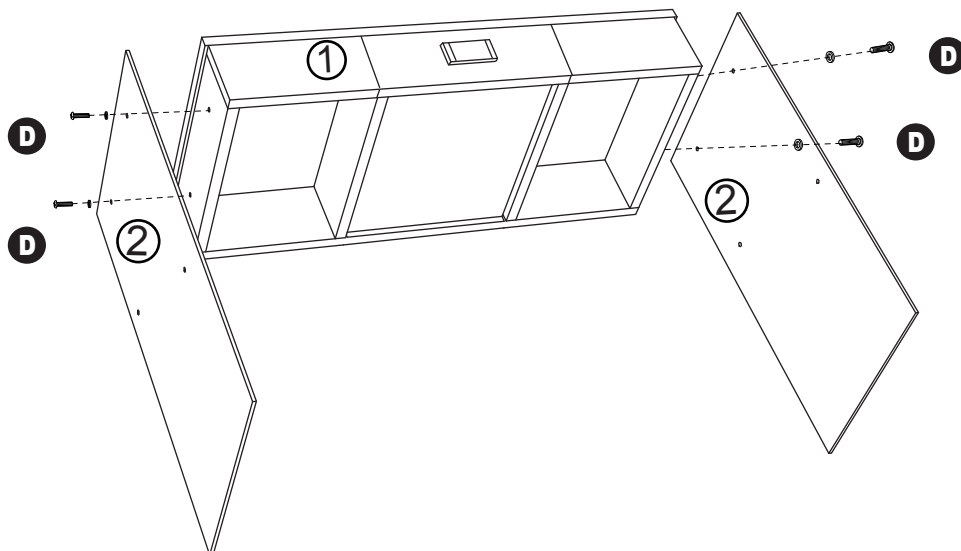

Step 4

1. Insert locking nuts (B) into bottom panel ③.
2. Connect back panel ③ to unit as shown using long screws and washers(A) .
3. Place the unit upright.

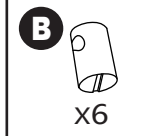
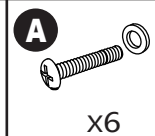
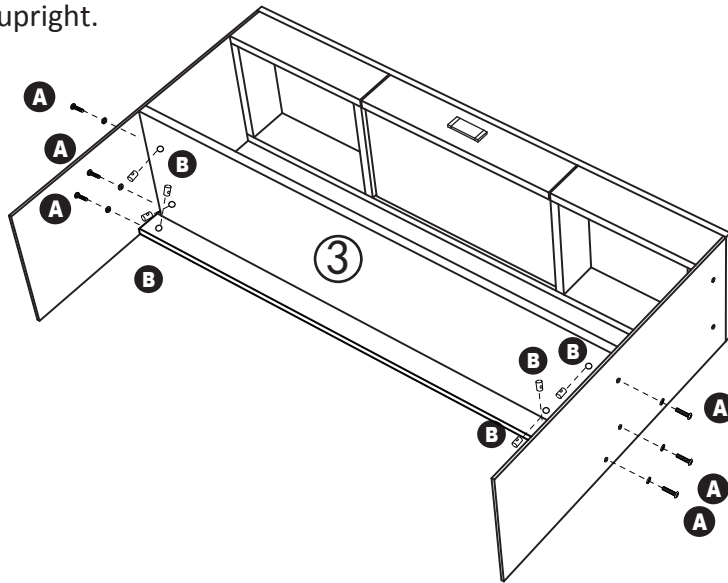

Step 4

1. Connect bracket (H) to unit as shown using short screw (G).
2. Drill hole slightly smaller than plastic anchor (I) into drywall and gently tap plastic anchor into hole.
3. Insert eyelet screw (F) into plastic anchor (I) and fasten unit to wall using cable tie (E) .

