

ASSEMBLY INSTRUCTION

SIDE CHAIR







IMPORTANT SAFETY CONSTRUCTION

Thank you for purchasing this quality product. Be sure to check all packing material carefully for small parts that may have come loose inside the carton during shipment. Please read all instruction carefully before assembling. For your safety, assembly by two people is recommended.

PARTS INCLUDED:

- (1) Chair Back (a)
- (1) Seat Frame (b)
- (2) Chair Legs (c)

HARDWARE ENCLOSED:

- A 4x  Ø8
- B 4x  Ø6 x 75mm
- C 2x  Ø6 x 40mm
- D 10x  Ø8 x 13mm
- E 10x  Ø8 x 19mm
- F 1x 
- G 1x 

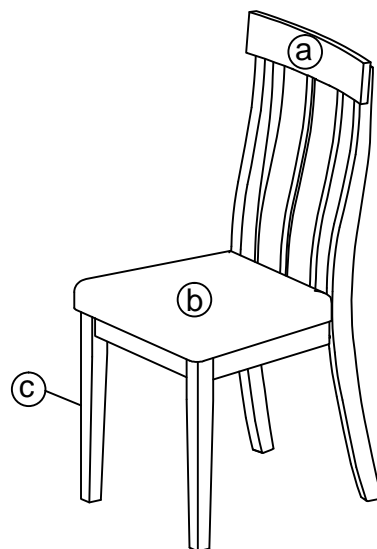

ASSEMBLY INSTRUCTIONS

STEP 1:

- Carefully lay Chair Back flat on a smooth flat surface to prevent scratches.
- Affix Complete Seat to Chair Back by inserting a Flat Washer (E), Lock Washer (D) with Short Bolt (C) into holes at the back rail of the seat, and Long Bolt (B) into holes at the Seat frame corners. (See Detail A & B).
- Tighten screws with provided Allen Key (F) by turning clockwise until secure

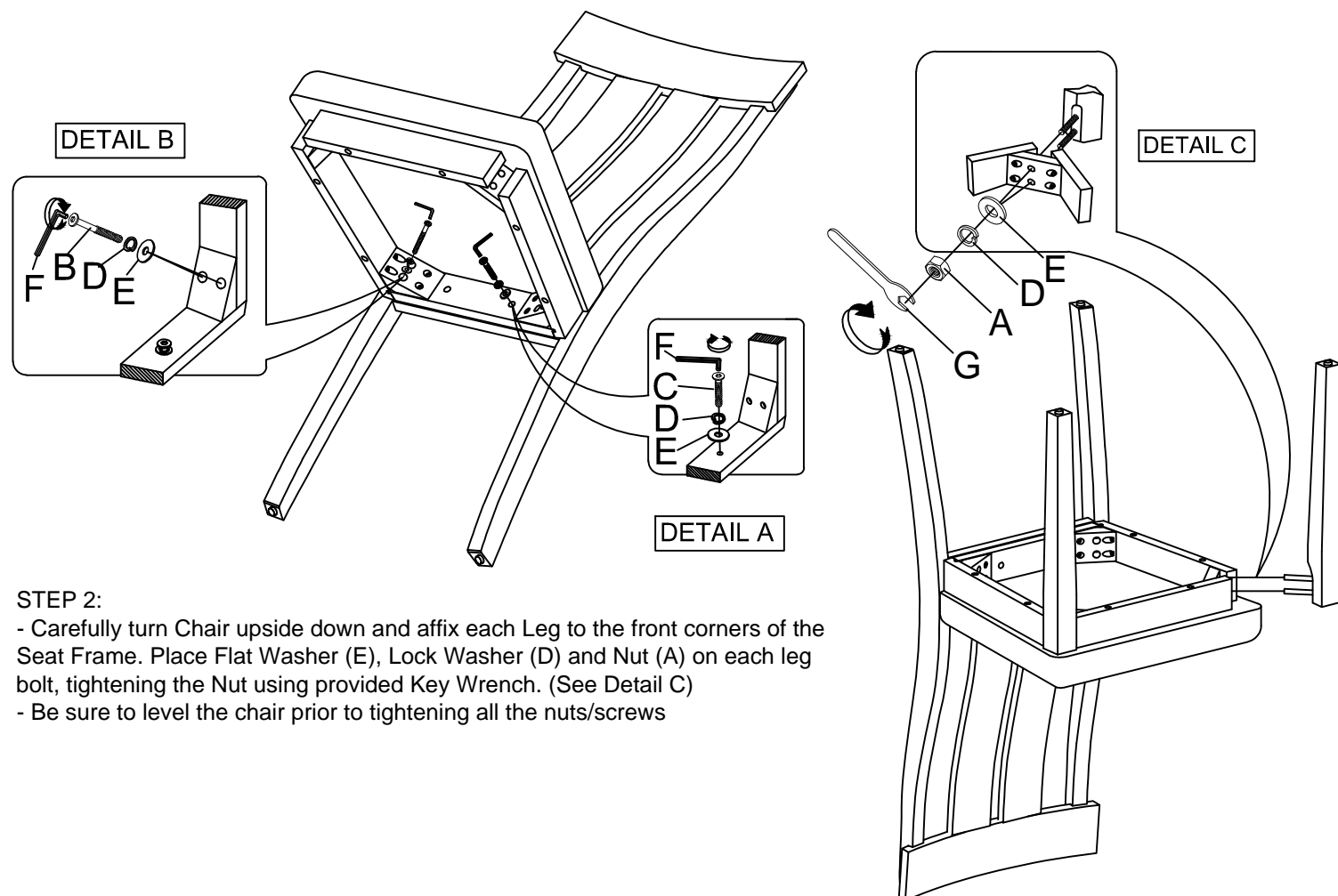

STEP 2:

- Carefully turn Chair upside down and affix each Leg to the front corners of the Seat Frame. Place Flat Washer (E), Lock Washer (D) and Nut (A) on each leg bolt, tightening the Nut using provided Key Wrench. (See Detail C)
- Be sure to level the chair prior to tightening all the nuts/screws

NOTES:

The use of power tools for assembly is not recommended. Power tools can damage hardware or split wood.