



# WARNING!!

**NEVER allow children to climb or hang on furniture, including drawers or cabinet doors.**

**In addition to installing the restrains, to help prevent tip-over**

- 1. NEVER put a TV or other heavy objects on top of this product".**
- 2. Do not stand on the product.**





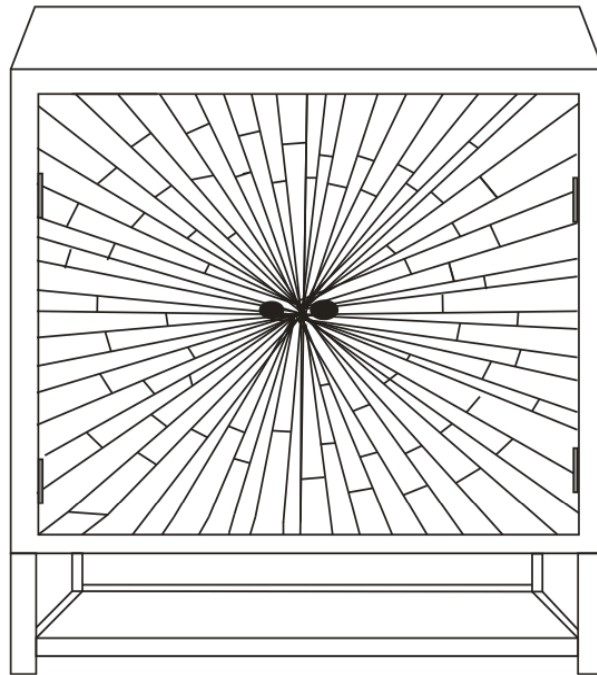

<b>⚠ WARNING</b>	
	<p><b>Children have died from furniture tipover. To reduce the risk of furniture tipover:</b></p> <ul style="list-style-type: none"><li>• ALWAYS install tipover restraint provided.</li><li>• NEVER put a TV on this product.</li><li>• NEVER allow children to stand, climb or hang on drawers, doors, or shelves.</li><li>• NEVER open more than one drawer at a time.</li><li>• Place heaviest items in the lowest drawers.</li><li>• Do not defeat or remove the drawer interlock system.</li></ul> <p><i>This is a permanent label. Do not remove!</i></p>
	

# Assembly Instructions

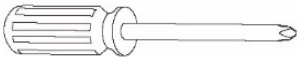
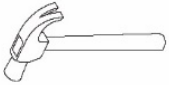
**Caution : You must read this before you proceed**

## CABINET

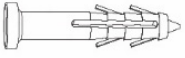

Hardware			
Label	Picture	Description	QTY
①		Screwdriver (Not provided)	1
②		Hammer (Not provided)	1
③		Power Drill (Not provided)	1
④		Bracket	2
⑤		Wall Plug Screw ( M8 x 50 mm)	4
⑥		Wall Plug (10 x 45 mm)	4
⑦		Tipover Restraint Strap	2
⑧		Knob	2

## Assembly Preparation

Before  
Beginning  
Assembly:

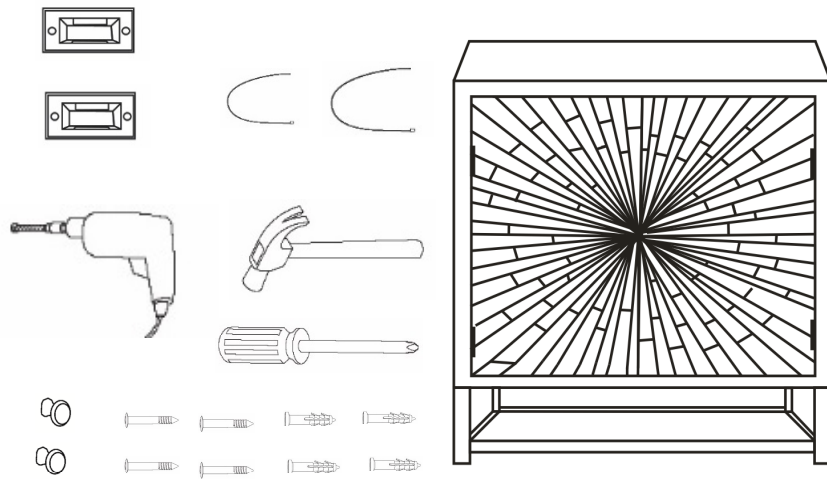

- Read instructions, cover to cover-



- Have 2 adults on hand for assembly-



- Do not assemble on flooring or carpet-



- Assemble on a clean non-marring surface (packing foam)-



- Save all packaging until finished-

## Assembly Steps

### Overview

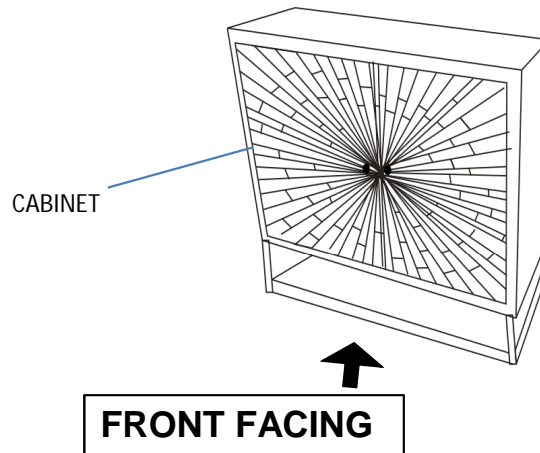

This Cabinet has multiple parts and may require up to some 30 minutes to assemble. To give you an overview of the Cabinet parts, the above picture is to help you put the various parts into perspective. Please read through the instructions below to familiarise yourself with the parts and steps before assembly.

## Step 1

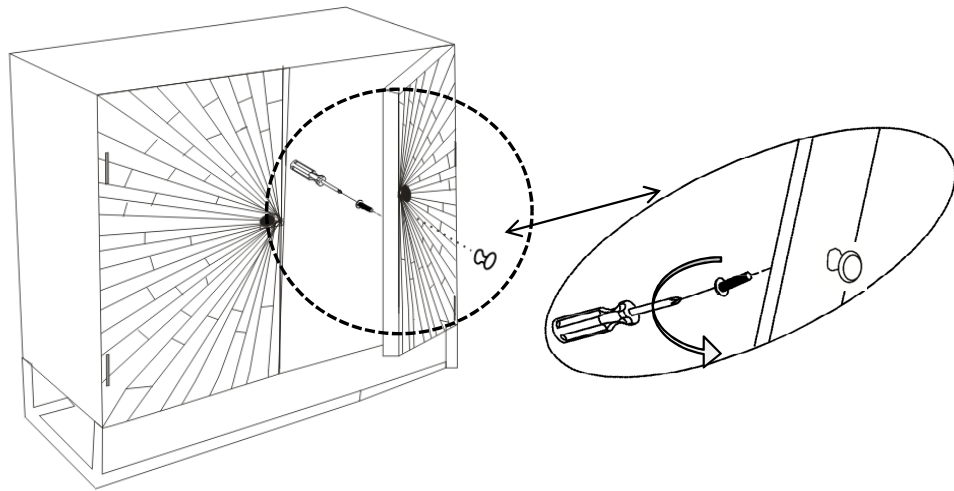

With help of your adult partner, carefully stand the Cabinet.  
Install the Knob (⑧) on the Door with the help of Screwdriver (①)  
as pictured above. Repeat the step to attach the remaining Knob  
(⑧) on the Door.

## **Tip-over Restraint Device Installation Instructions**



**Serious or fatal crushing injuries can occur from tipping furniture.**

**To help prevent tip-over: ALWAYS secure this furniture to the wall using Tip-over Restraint Device.**

**See product instructions for more ways to help prevent furniture tip-over.**

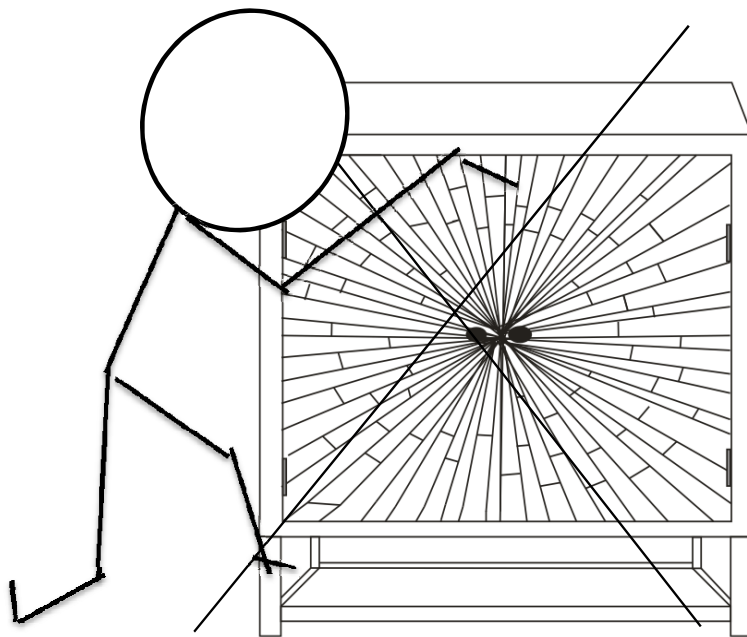

### **Usage For Tip-over Restraint Device:**

To secure Cabinet against wall, attach two Brackets (④) on wall and product, use Tip-over Restraint Strap (⑦) to connect the Brackets (④) .

## Step 2

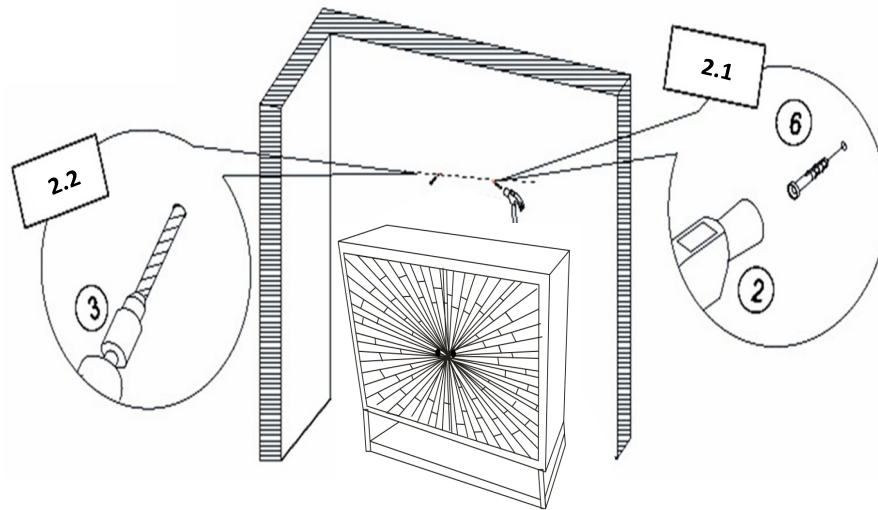

2.1) Drill two holes on wall at same height as Brackets (④) on Cabinet with Power Drill (③).

You can mark these points in two ways as below:

1) Move the Cabinet back to the wall. Mark two points same height as Cabinet on the wall.

**Note: The Brackets need to be secured to solid, load bearing surface. Please use a Stud Finder(not supplied) if needed to locate the Wall Frame.**

2) Measure the height of the Brackets (④) with ruler/measuring tape and mark on wall to keep them accurate and same height.

2.2) Insert Wall Plugs (⑥) into drilled holes on wall with Hammer (②).

## Step 3

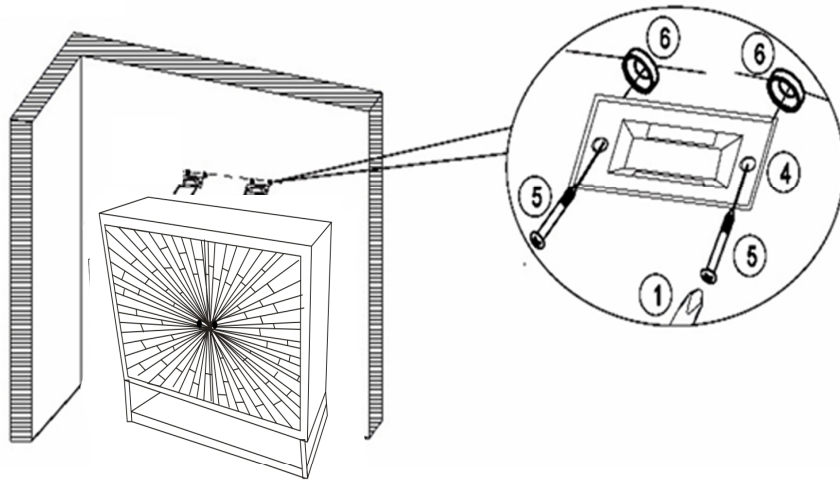

Attach Brackets (4) to Wall Plugs (6) using Wall Plug Screws (5) with Screwdriver (1).

## Step 4

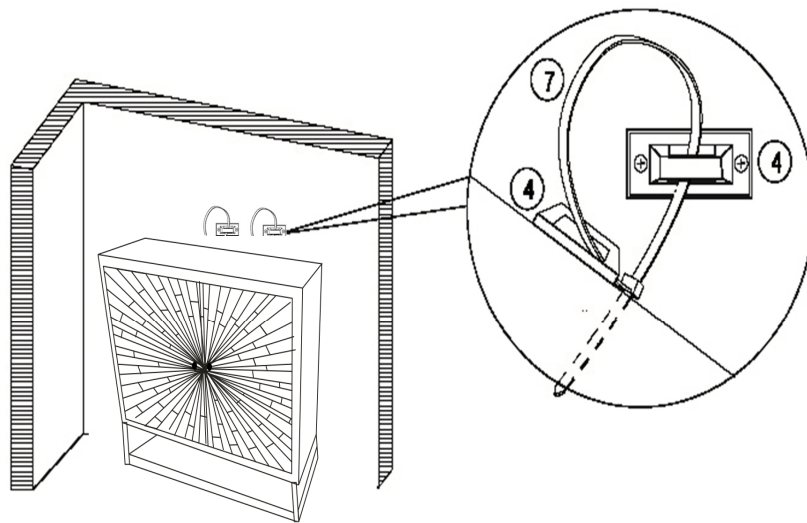











Move Cabinet to the wall.

Pull the Tipover Restraint Straps (7) through the Brackets (4) on the wall and Cabinet one by one, and pull the Tipover Restraint Straps (7) tight.

This Cabinet is now ready to use.

**Caution: This Cabinet can only be used on flat, level surface.**

## Care & Maintenance

- ✓  • Furniture may scratch floors. We recommend using furniture pads to protect your floors.
- ⊘  • Do not put hot items directly on furniture surface
- ⊘  • Do not clean furniture with harsh cleansers or polish.
- ⊘  • Do not place furniture under direct sunlight.
- ⊘  • Do not place furniture near heating or cooling vents.
- ⊘  • Do not write on furniture without a passed barner to protect the surface.
- ⊘  • Do not place furniture outside. for indoor use only.
- ⊘  • Not for commercial use. for residential use only.
- ⊘  • Stains may be removed with mild soap solution and damp cloth.
- ⊘  • Children should not climb or jump on the furniture.
- ✓  • Dust and pick - up shills using a clean, non-colored, lint-free cloth.