

# ASSEMBLY INSTRUCTIONS

---

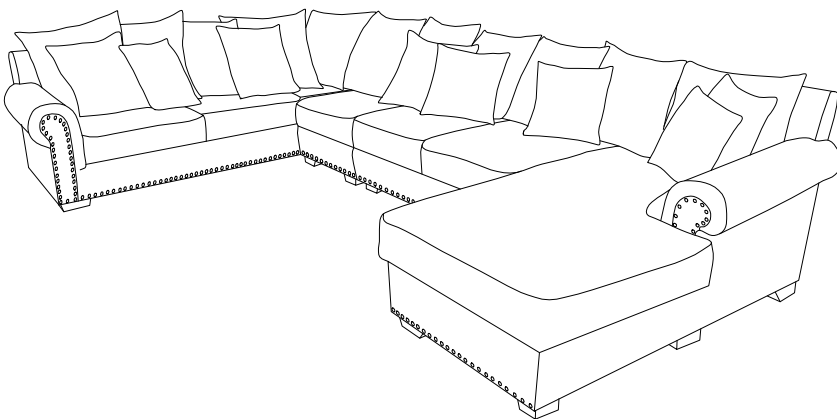

## TOOLS REQUIRED

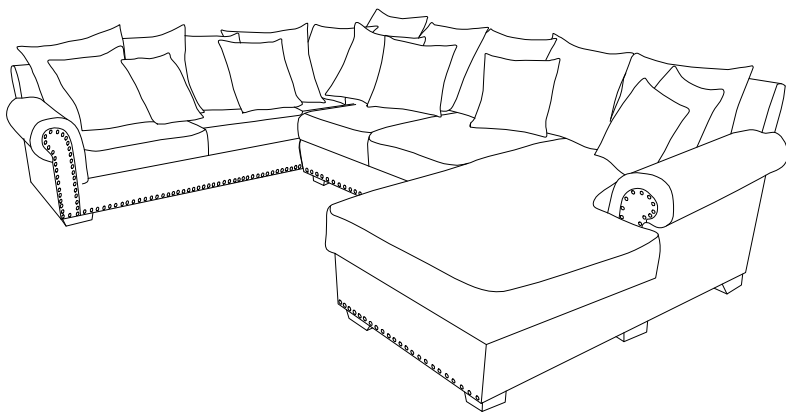

Allen Wrench  
(Included)



**2 - People  
Recommended**

## ASSEMBLY RATING



EASY → DIFFICULT

The Assembly Rating is a 5-point system showing the level of effort needed to assemble a specific product.

Thank you for your purchase!

We hope you enjoy this new addition to your home for many years to come.

Our commitment to providing quality products does not simply end when you purchase our product. We fully stand behind our products from start to finish. Our customer service department is available and can help with assembly questions as well as, if necessary, replacing damaged or missing parts. To help expedite our service, please have these assembly instructions readily available, along with your order receipt.



## **CHECK BEFORE STARTING**

### **Are you missing anything?**

Double-check all parts, hardware and accessories listed on Page 6 are accounted for.

### **Check out our Quick Tips!**

We recommend reviewing the pre-assembly handouts. Even experts need a refresher now and then!

### **Should we send any replacements?**

Are there any irregularities or flaws in the parts? We can send replacements!

### **Prep Time!**

Please review the assembly instructions and all diagrams prior to assembling. Arrange parts as recommended on Page 7 and group identical hardware together to make assembling easier.

# PRE ASSEMBLY INTRODUCTION

We understand building ready-to-assemble furniture can be a challenging experience for some. To help avoid confusion, we have provided some helpful tips that may speed up the process.



## Teamwork

ALWAYS have at least two people to help with transporting and assembling the product to avoid potential injury and/or damage.



## Suitable Location

Assembling near the area of the intended location is highly recommended.



## Sufficient Space

Make sure you have enough space to move around during the assembly.



## Avoid Scratches

Use cardboard, blankets or a carpeted area while assembling furniture to prevent to prevent scratches and damages.



## Flat Surface

Make sure the furniture rests on a flat and level surface with each leg evenly touching the floor.

# ASSEMBLY AND CARE ADVICE



**FAILURE TO FOLLOW THE GUIDELINES BELOW MAY RESULT IN INJURY AND/OR PROPERTY DAMAGE.**



Position each part correctly and insert screws or bolts into their respective holes.



Turn clockwise to tighten and only tighten when step is completed or when instructed to do so.



Use the appropriate hand tools or power tools for assembly. Select steps, such as tightening screws and/or bolts, may require hand tools to avoid causing damage during assembly.



Save the instructions and store any supplied tools for later maintenance.



After two weeks, check and tighten any loose hardware and repeat again every six months thereafter.

**IT IS THE USER'S RESPONSIBILITY TO MAINTAIN THE FURNITURE. THE HARDWARE MAY LOOSEN OVER TIME AND MAY CAUSE THE FURNITURE TO BE WOBBLY AND UNABLE TO SUPPORT ITS INTENDED WEIGHT CAPACITY. THIS MAY LEAD TO COLLAPSE AND MAY CAUSE SERIOUS INJURY.**

# SOFA

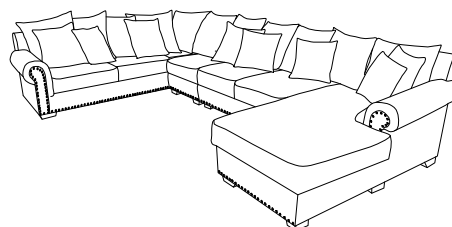
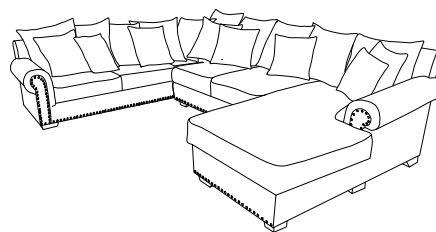

- Please keep instructions for future reference.
- Check the quantity and irregularity of parts and hardware before you start.

## PARTS

#1 1pc

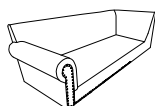

Left Sofa

#2 2pcs

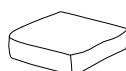

Sofa Seat Cushion 1

#3 1pc



Sofa Seat Cushion 2

#6 1pc



Loveseat

#7 2pcs



Loveseat Seat Cushion

#8 1pc



Right Chaise

#9 1pc



Chaise Seat Cushion

#10 4pcs

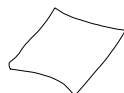

Big Pillow

#11 4pcs



Small Pillow

#12 4pcs



Flower Pillow

#13 13pcs



Leg

#14 1pc



Support Leg

## 4-PIECE SECTIONAL ADD-ONS

#4 1pc



Armless Chair

#5 1pc

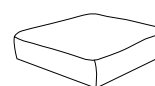

Chair Seat Cushion

#10 1pc



Big Pillow

#13 4pcs



Leg

## HARDWARE

#A 13pcs

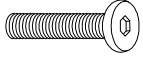

Bolt Ø5/16" x 3-1/2"

#B 13pcs



Lock Washer Ø5/16"

#C 13pcs

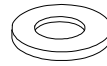

Flat Washer Ø5/16"

#D 3pcs



Allen Key 5mm

## 4-PIECE SECTIONAL ADD-ONS

#A 4pcs

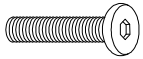

Bolt Ø5/16" x 3-1/2"

#B 4pcs



Lock Washer Ø5/16"

#C 4pcs



Flat Washer Ø5/16"

#D 1pc

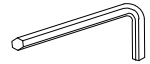





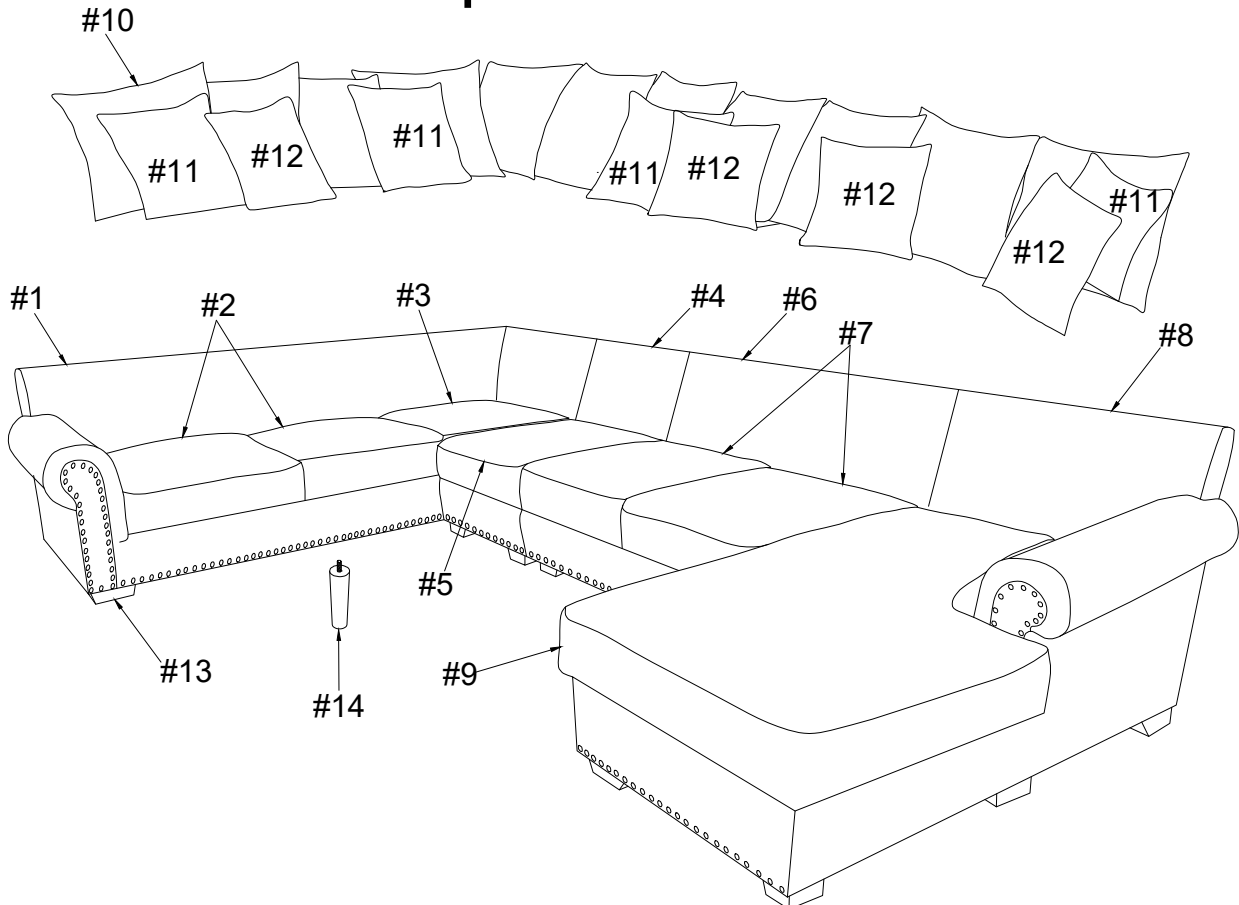























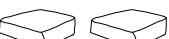









Allen Key 5mm

## Exploded View

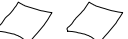

# packed in 4 cases

Carton	Disignation	Part	Hardware
CM6156-1	Left Sofa	#1 	
	Sofa Seat Cushion 1(2pcs)	#2 	
	Sofa Seat Cushion 2	#3 	 #A x 4pcs
	Support Leg	#14 	 #B x 4pcs
	Leg (4pcs)	#13 	 #C x 4pcs
	Big Pillow (5pcs)	#10 	 #D x 1pc
	Small Pillow (2pcs)	#11 	
	Flower Pillow (2pcs)	#12 	
CM6156-CH	Armless Chair	#4 	 #A x 4pcs
	Chair Seat Cushion	#5 	 #B x 4pcs
	Leg (4pcs)	#13 	 #C x 4pcs
	Big Pillow	#10 	 #D x 1pc
CM6156-2	Loveseat	#6 	
	Loveseat Seat Cushion	#7 	 #A x 4pcs
	Leg (4pcs)	#13 	 #B x 4pcs
	Big Pillow (3pcs)	#10 	 #C x 4pcs
	Small Pillow	#11 	 #D x 1pc
	Flower Pillow	#12 	
CM6587-3	Right Chaise	#8 	
	Chaise Seat Cushion	#9 	 #A x 5pcs
	Leg (5pcs)	#13 	 #B x 5pcs
	Big Pillow (2pcs)	#10 	 #C x 5pcs
	Small Pillow	#11 	 #D x 1pc
	Flower Pillow	#12 	

# ASSEMBLY INSTRUCTIONS

1

(Applies to 4-piece sectional only)

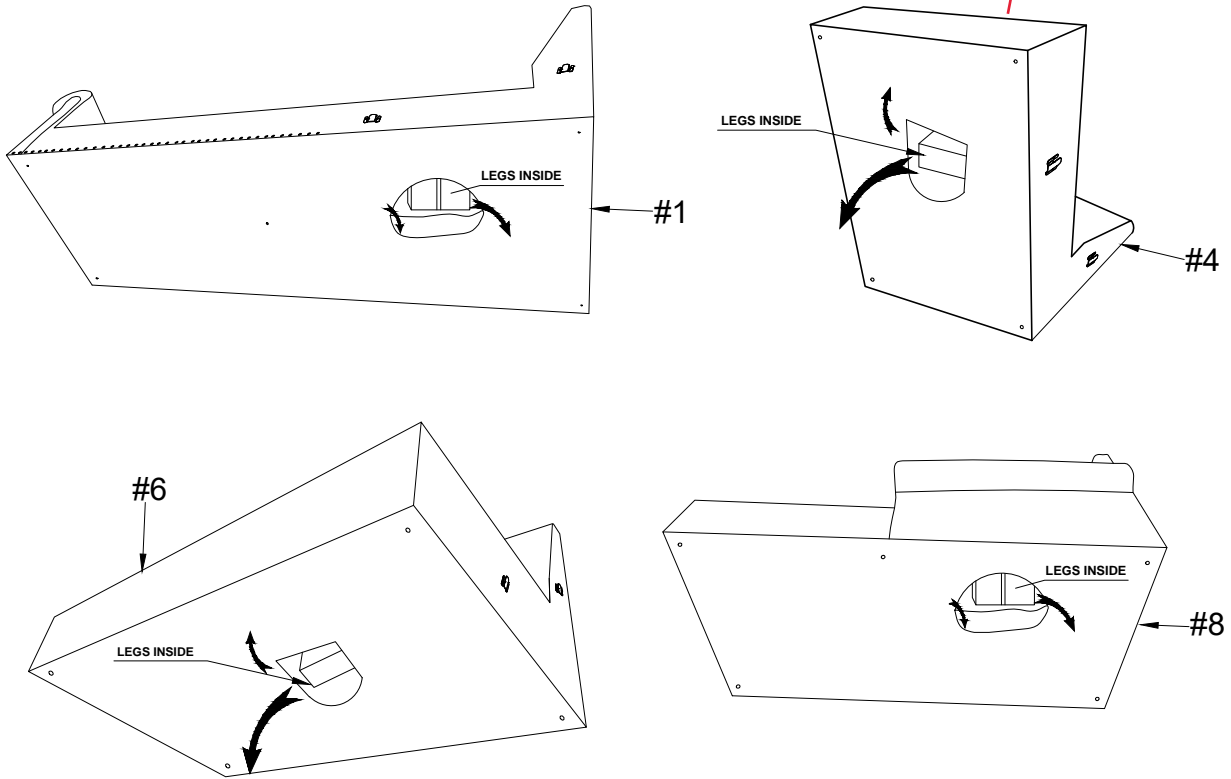

2

- Part #1 x1pc
- Part #13 x4pcs
- Part #14 x1pc
- Hardware #A x4pcs
- Hardware #B x4pcs
- Hardware #C x4pcs

Attach support leg (#14) to the left sofa (#1).

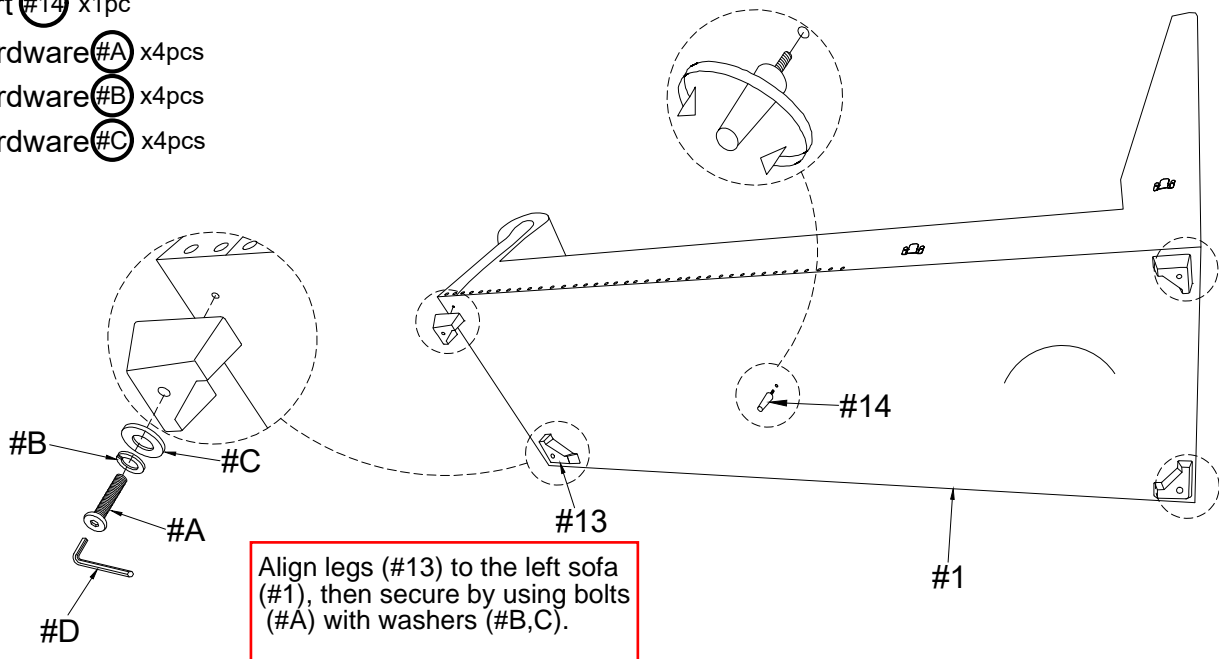

Align legs (#13) to the left sofa (#1), then secure by using bolts (#A) with washers (#B,C).

# ASSEMBLY INSTRUCTIONS

## 3

Part #2 x2pcs

Part #3 x1pc

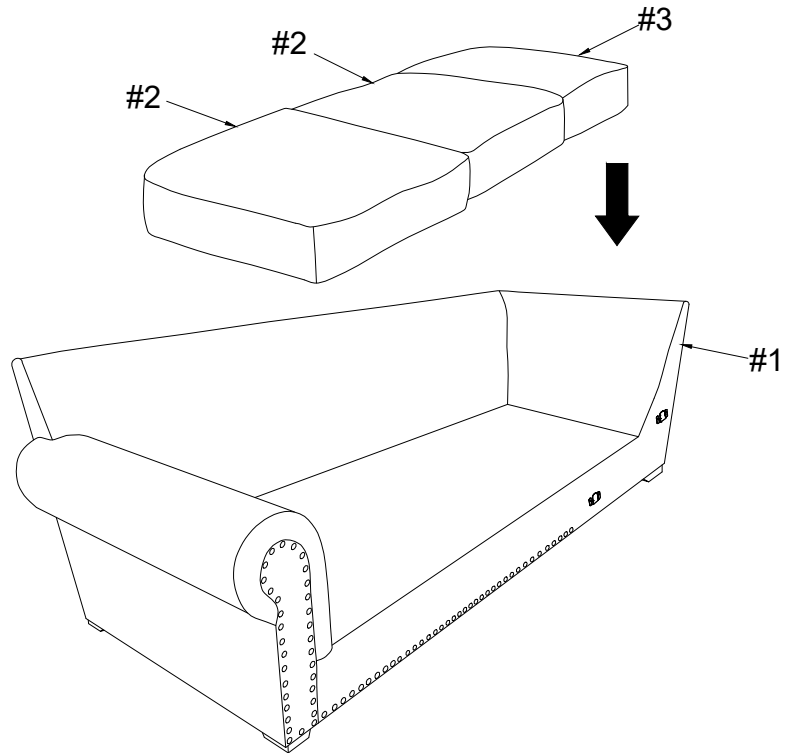

## 4 (Applies to 4-piece sectional only)

Part #4 x1pc

Part #13 x4pcs

Hardware #A x4pcs

Hardware #B x4pcs

Hardware #C x4pcs

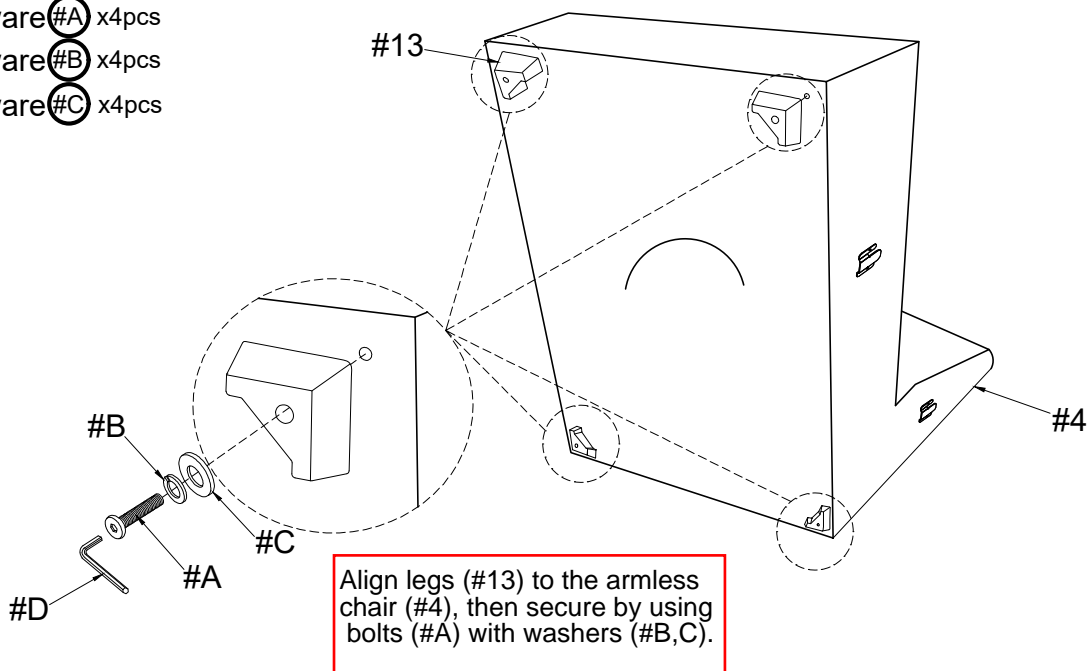

# ASSEMBLY INSTRUCTIONS

## 5 (Applies to 4-piece sectional only)

Part #5 x1pc

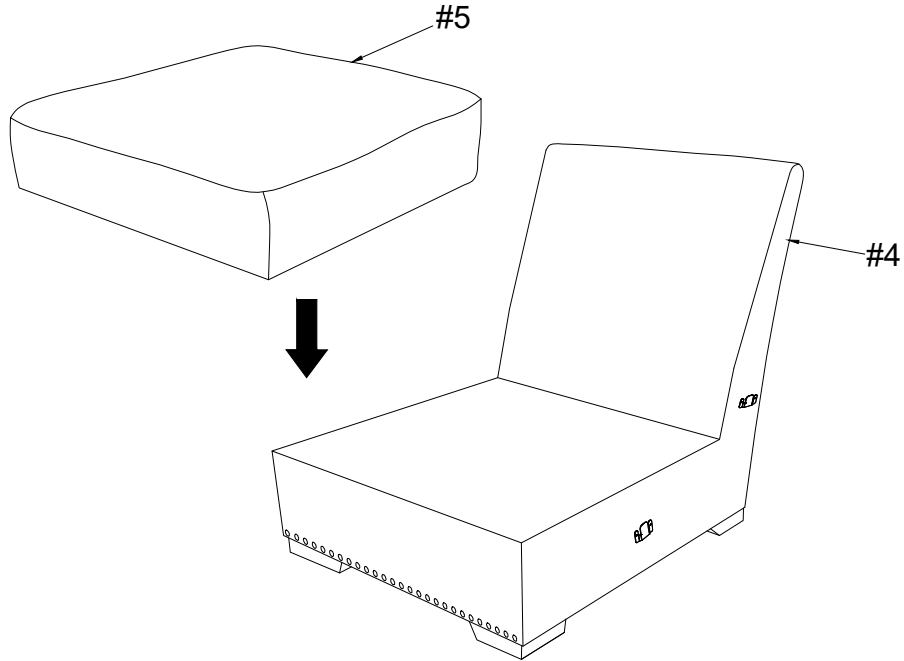

## 6

Part #6 x1pc

Part #13 x4pcs

Hardware #A x4pcs

Hardware #B x4pcs

Hardware #C x4pcs

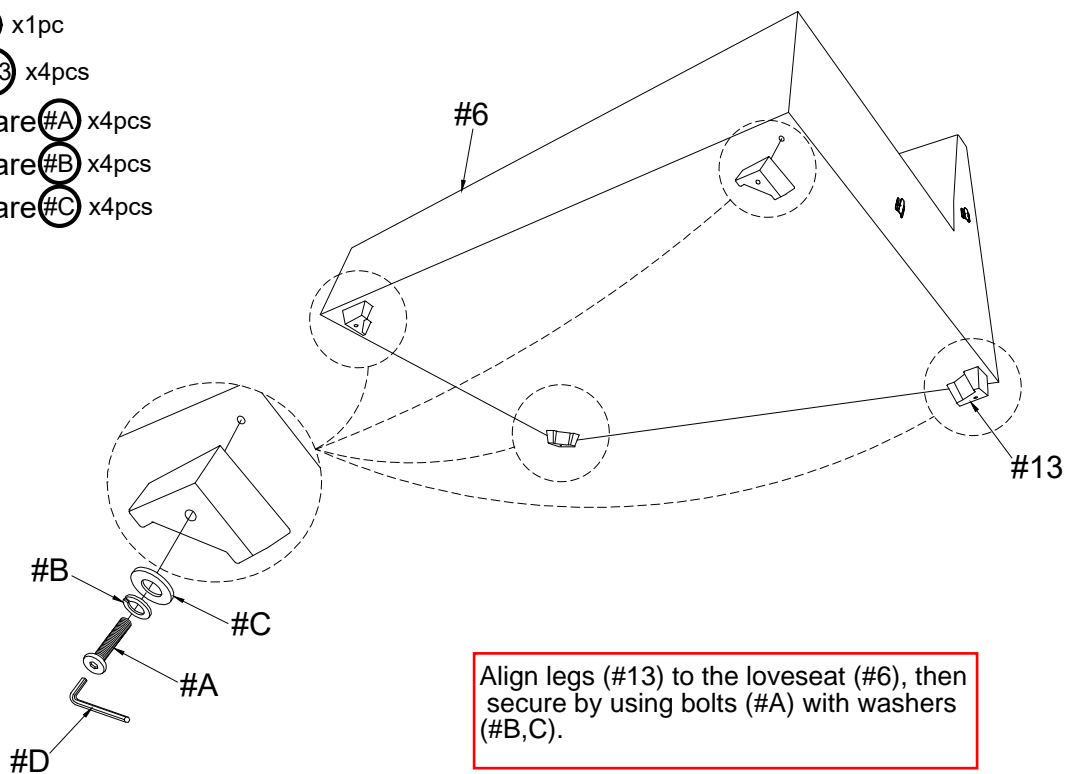

# ASSEMBLY INSTRUCTIONS

## 7

Part #7 x2pcs

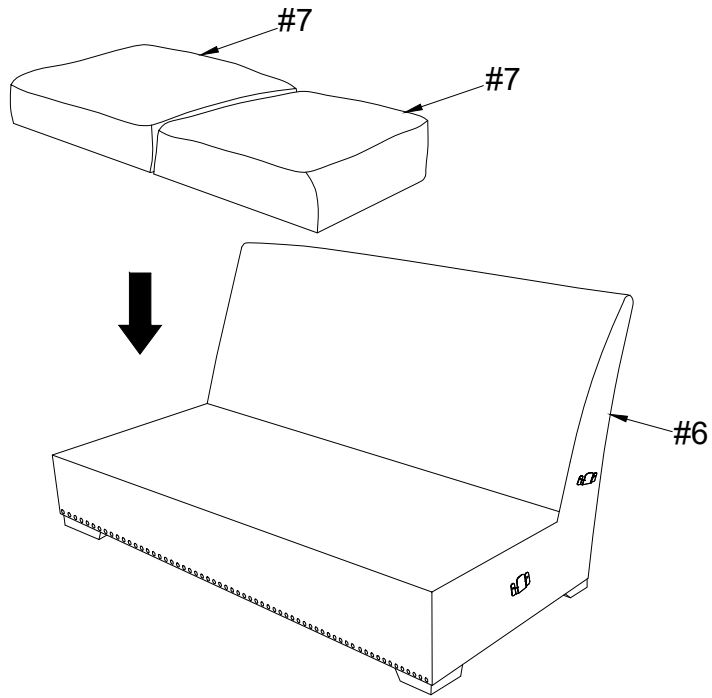

## 8

Part #8 x1pc

Part #13 x5pcs

Hardware #A x5pcs

Hardware #B x5pcs

Hardware #C x5pcs

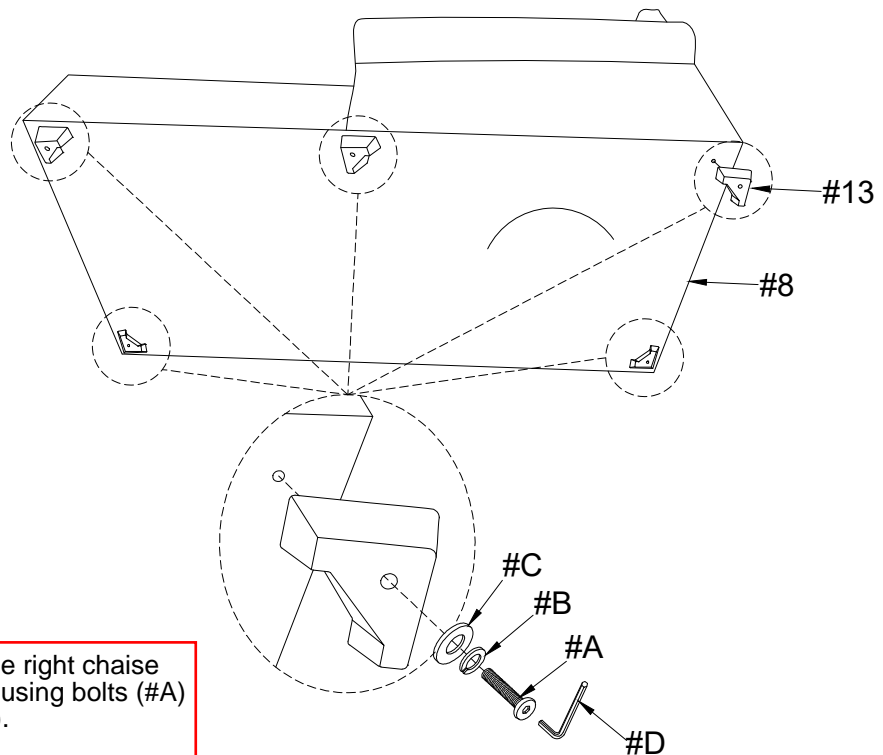

Align legs (#13) to the right chaise (#8), then secure by using bolts (#A) with washers (#B,C).

# ASSEMBLY INSTRUCTIONS

9

Part #9 x1pc

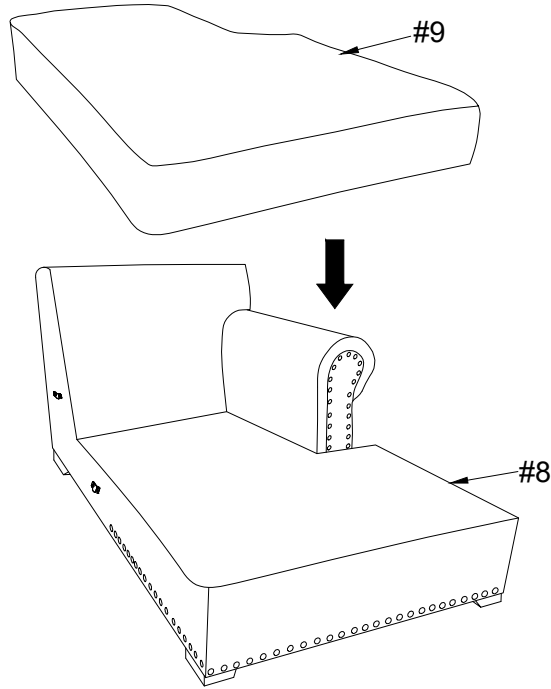

10

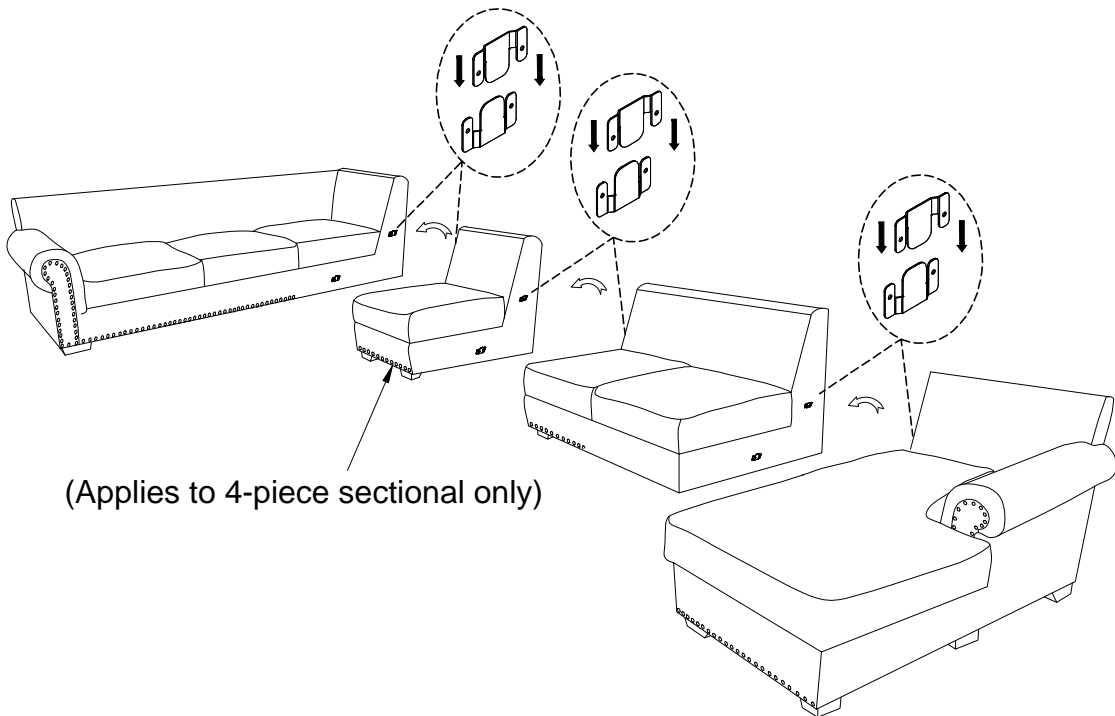

# ASSEMBLY INSTRUCTIONS

# 11

Part #10 x11pcs

Part #11 x4pcs

Part #12 x4pcs

(One pillow (#10) applies to 4-piece sectional only)

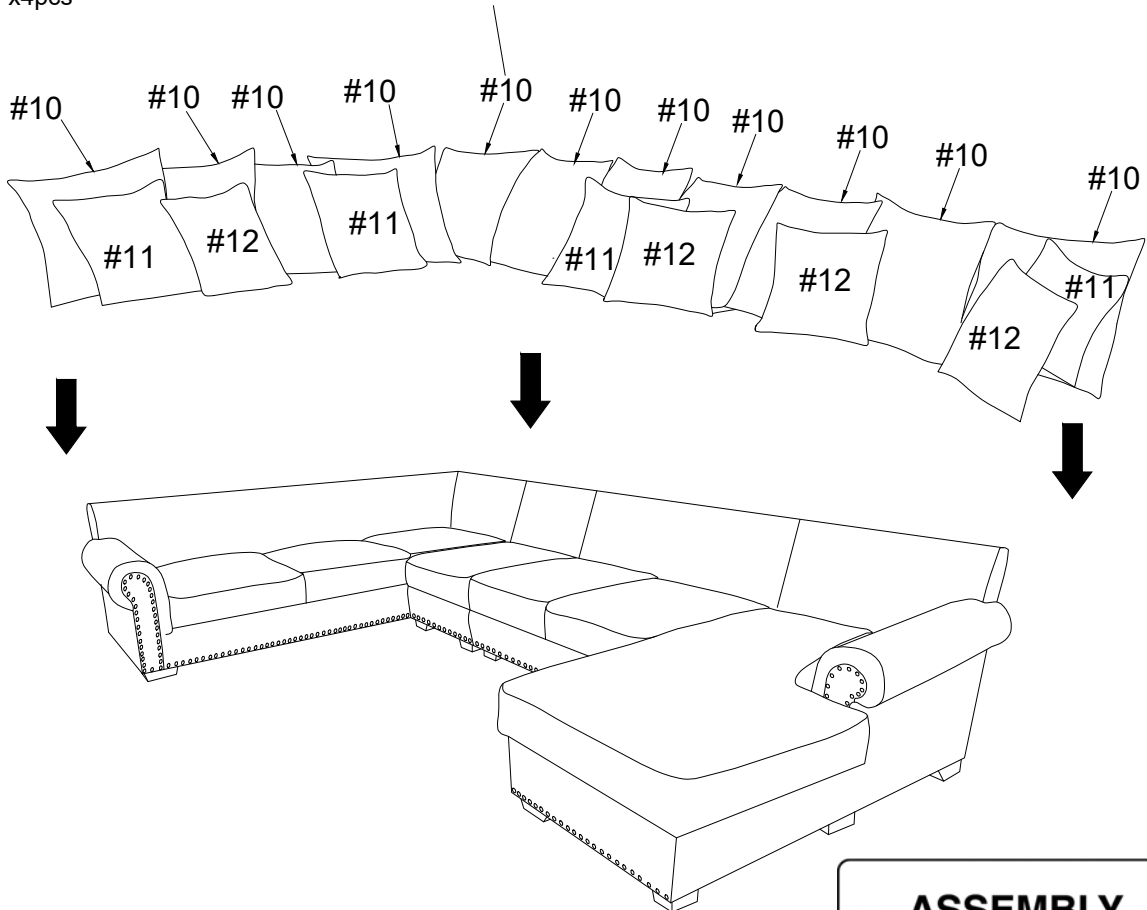

## ASSEMBLY COMPLETED



Please ensure the furniture rests on an even and flat surface. If the product wobbles or feels loose, double-check all bolts and/or screws are properly tightened and secured.

### ✓ Keep this handy!

Please retain this instruction manual and any order-related information for future reference.

### ✓ Lift, don't drag!

To avoid damage to product please always LIFT the product when transporting or adjusting the placement.