

NOTICE

- * Please make sure that you have all parts indicated and they are in good condition before you begin assembly of this item. Refer to part list and hardware list below for guidance.
- * This item should be assembled on a soft surface to prevent scratching the finish during assembly.
- * This item may require periodic tightening.







PREPARATION

- * Before beginning assembly of product, make sure all parts are present. Compare parts with part contents list and hardware contents list.
- * If any part is missing or damaged, do not attempt to assemble the product.
- * Estimated Assembly Time: 10 minutes.

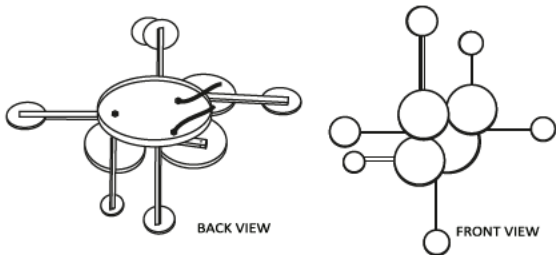
CARE AND MAINTENANCE

- * Before cleaning any lampshade or fixture, disconnect the power source.
- * Wipe with damp cloth. Avoid the use of chemical and household cleaners as they may damage the finish.

Part List and Hardware List

PIECE	DESCRIPTION	PICTURE	QUANTITY
A	Lamp		1X
B	Rod		1X
H1	Mid Screw (8x8x21 mm)		2X
H2	Plastic Screw Anchor		2X
H3	Short Screw (7x7x13 mm)		2X
H4	Long Screw (8x8x600 mm)		2X
H5	P2 (Wire Connector)		3X

PRODUCT DIMENSION - 22.5"Wx5"Dx32"H

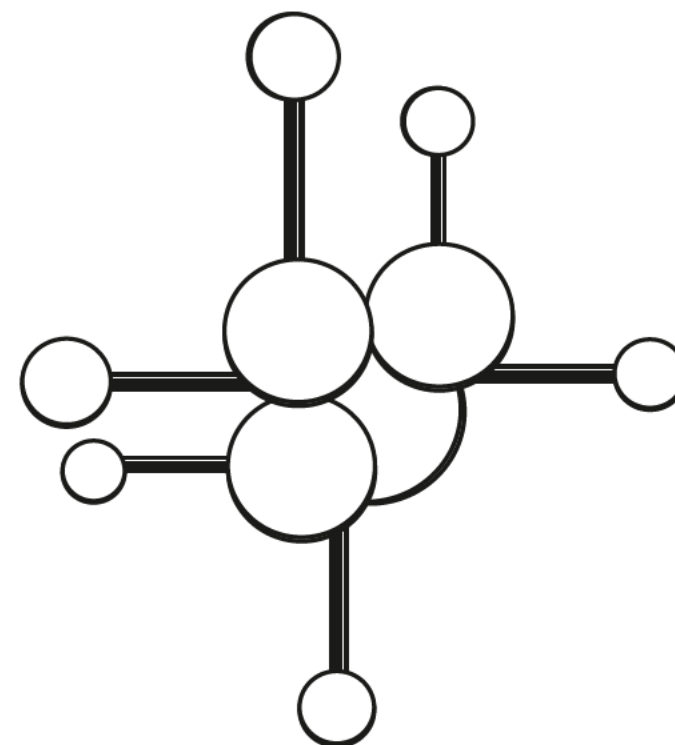

40 watt max type A bulb (NOT INCLUDED)
OR
9 watt max LED bulb (NOT INCLUDED)

PREPARATION

- * Before beginning assembly of product, make sure all parts are present. Compare parts with part contents list and hardware contents list.
- * If any part is missing or damaged, do not attempt to assemble the product.
- * Estimated Assembly Time: 10 minutes.

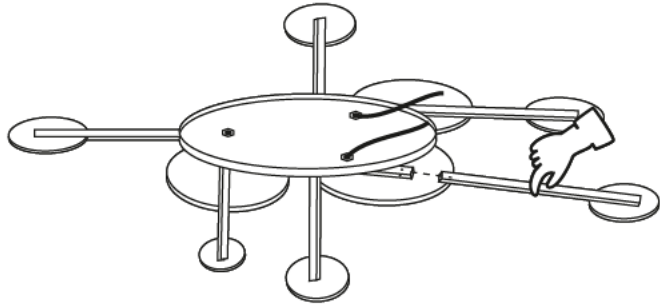

Step: Put the lamp from back side & align the rod (part-B)

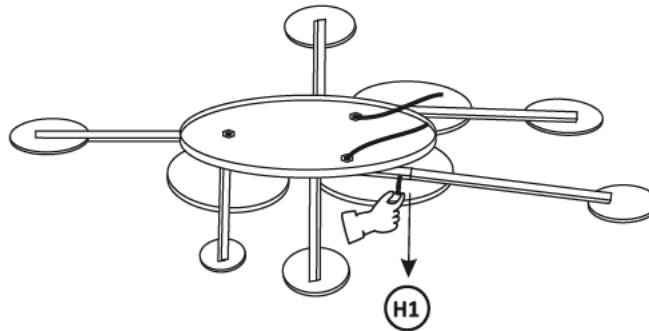

Step: Use mid screw 'H1' to tighten assemble the rod into lamp

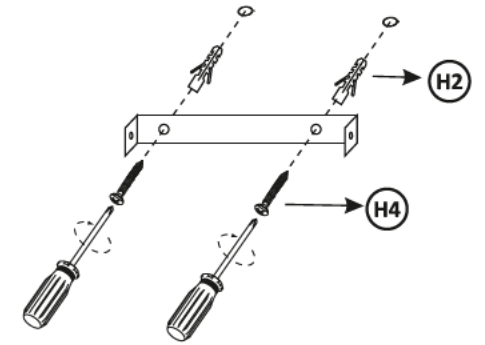

Step: Fix 'H2' into wall, Use long screw 'H4' to fix the canopy strip into wall

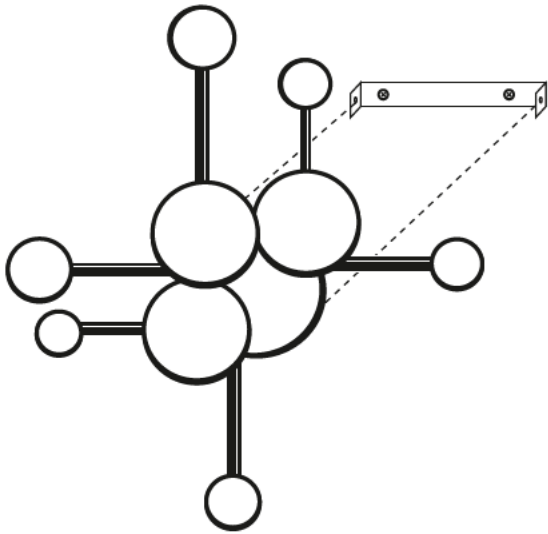

Step: Align the canopy with canopy strip

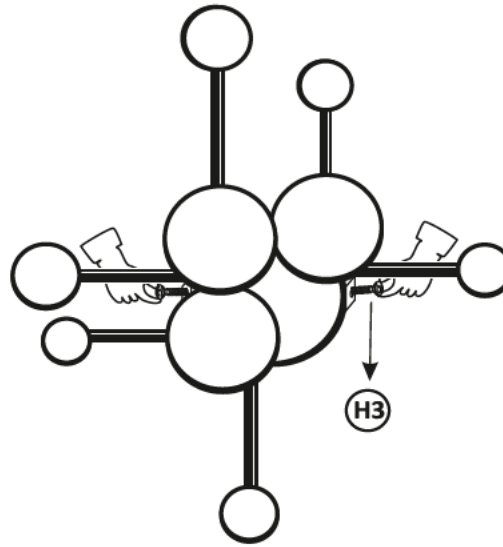

Step: Use 'H3' to fix the lamp into canopy strip

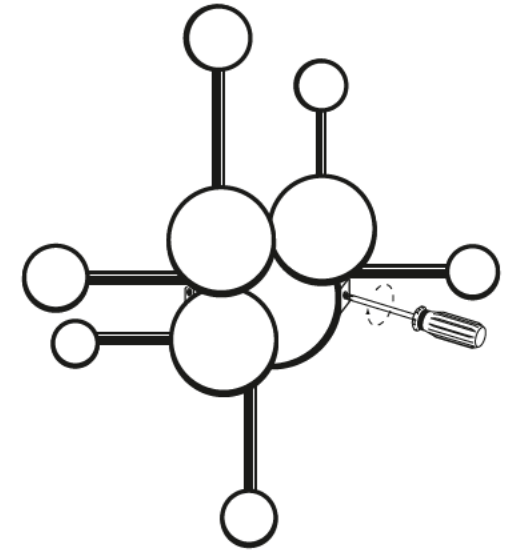

Step: Tighten the 'H3' to canopy strip.