

Installation Manual

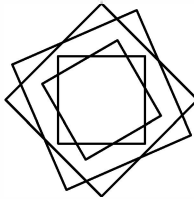

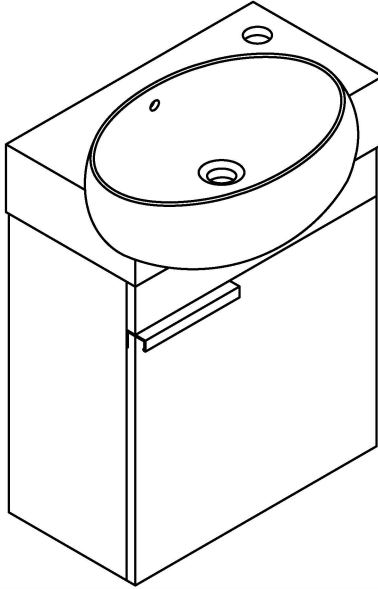









**MOTIVATE
YOUR LIFE !**



Thank you for shopping with us!

We encourage you to take a few minutes to go through this booklet. It contains important information on installation and care tips to keep your furniture looking as good as new.

Hardware

NO.	Draw	QTY	NO.	Draw	QTY
A	 Screws Ø4x14mm	32	H	 Bracket (19x19x35mm)	2
B	 Two-in-one connector	12	I	 Hinges (Full cover)	2
C	 Two-in-one connector	12			
D	 Wood plug	2	J	 Handle (Screws Ø4x14mm)	1
E	 Plastic anchor(Ø10mm)	2	K	 Anti-collision gasket	2
F	 Screws for fix on the wall	2	L	 Screwdriver	1
G	 Bracket (53x70x44mm)	2			

Recommended Tools

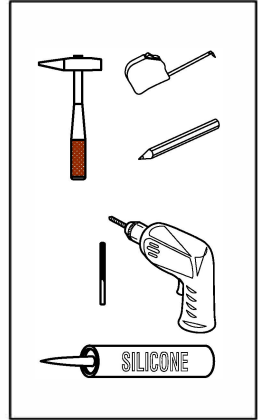

Components

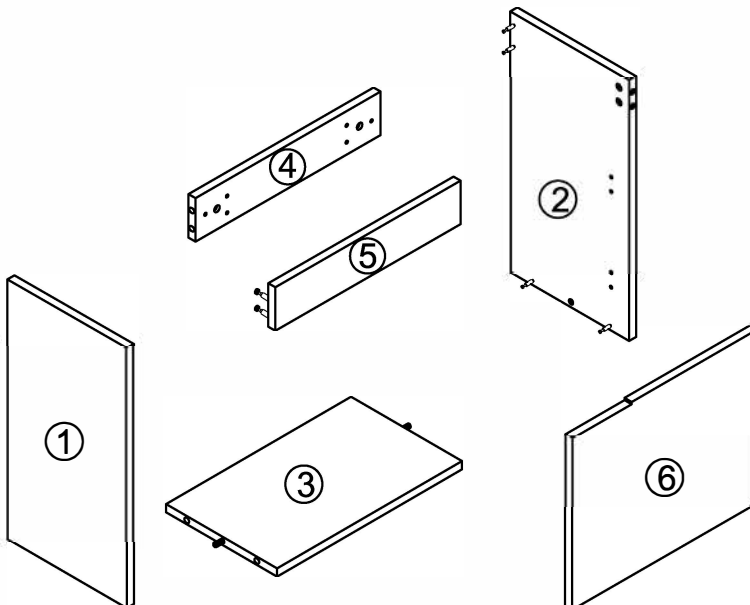

Step 1

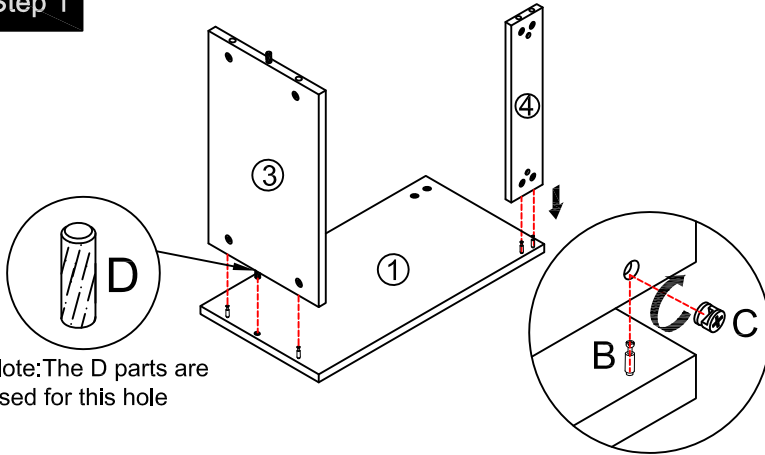

Note: The D parts are used for this hole

	x4
B	
	x4
C	
	x1
D	
	x1
L	

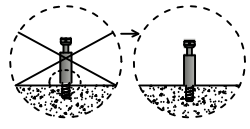
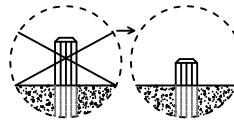
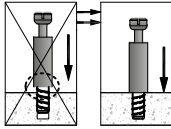
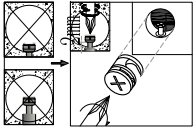

Notes: Screw installation depth as shown

Step 2

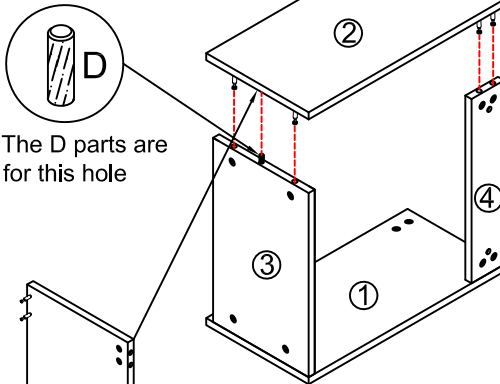

Note: The D parts are used for this hole

	x4
B	
	x4
C	
	x1
D	
	x1
L	

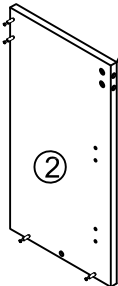

first step

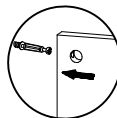

second step

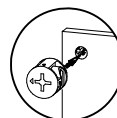

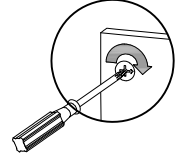

third step

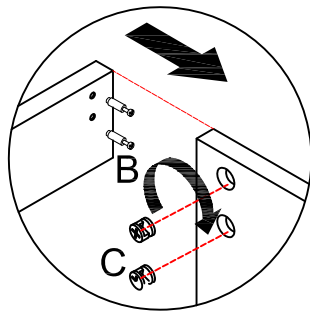
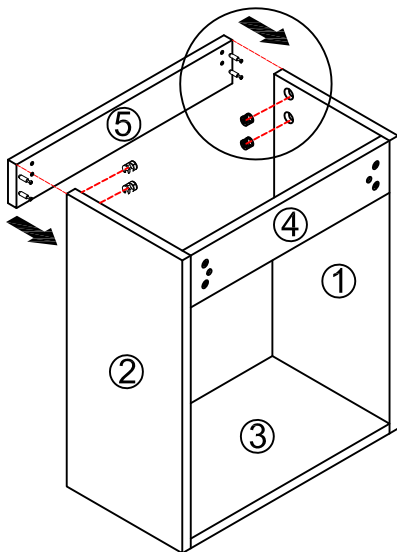

Step 3



-  x4
- B
-  x4
- C
-  x1
- L



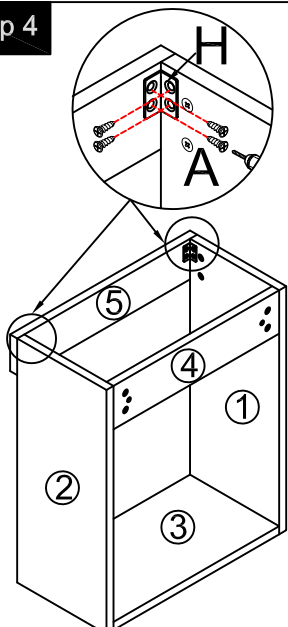

Step 4

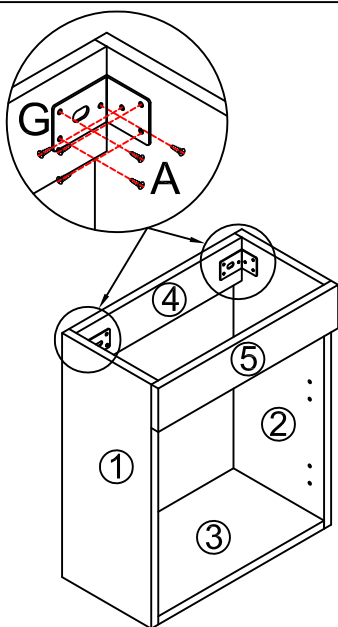

Back View





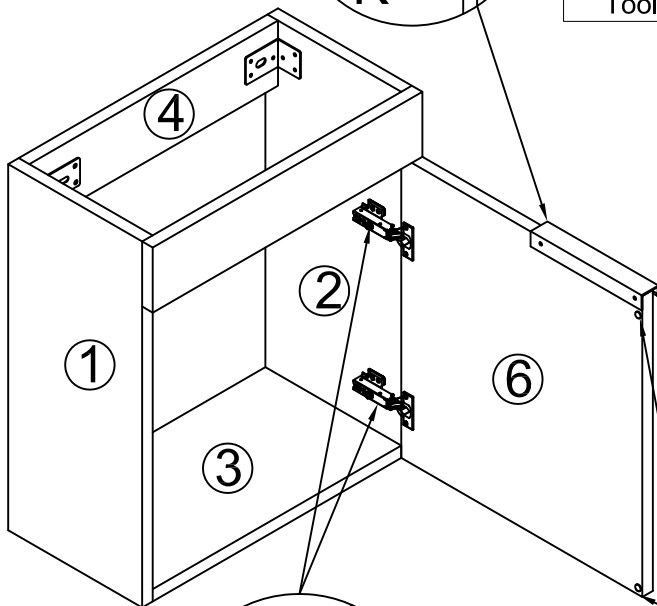

Front View

-  x2
- H
-  x2
- G
- (\varnothing 4 x 14mm)
-  x20
- A
- 
- Tool

Step 5





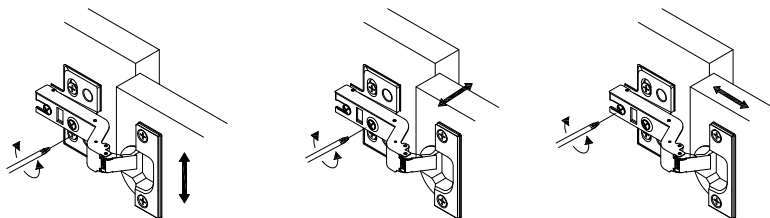
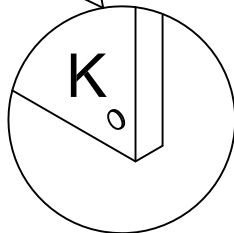
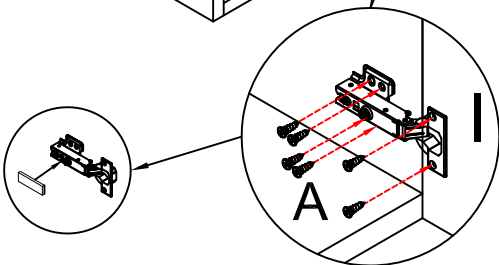

 x2	 x2
K	I ($\varnothing 4 \times 14\text{mm}$) x12
	A
	 x1
	J

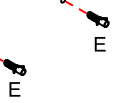
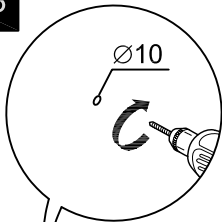

You can adjust the doors by tightening or loosening the screws on the hinge.



Step 6

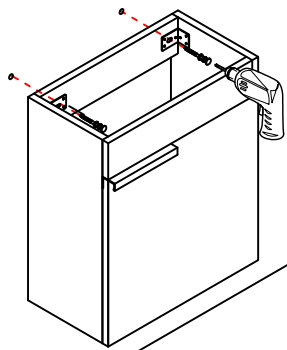

-  x2
- E
-  Tool
-  Tool

Step 7



-  x2
- F
-  Tool

Step 8

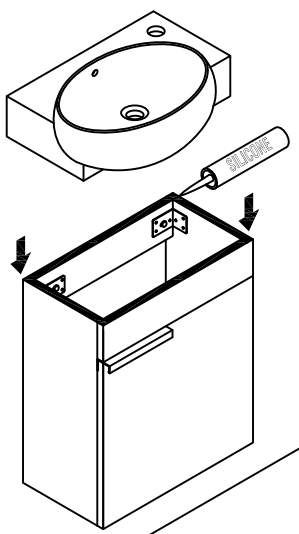

Finished

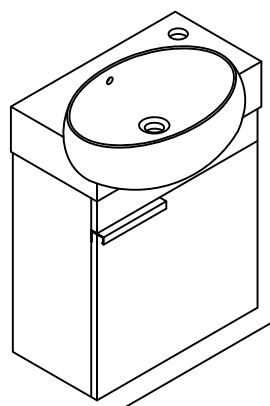

Dimensions

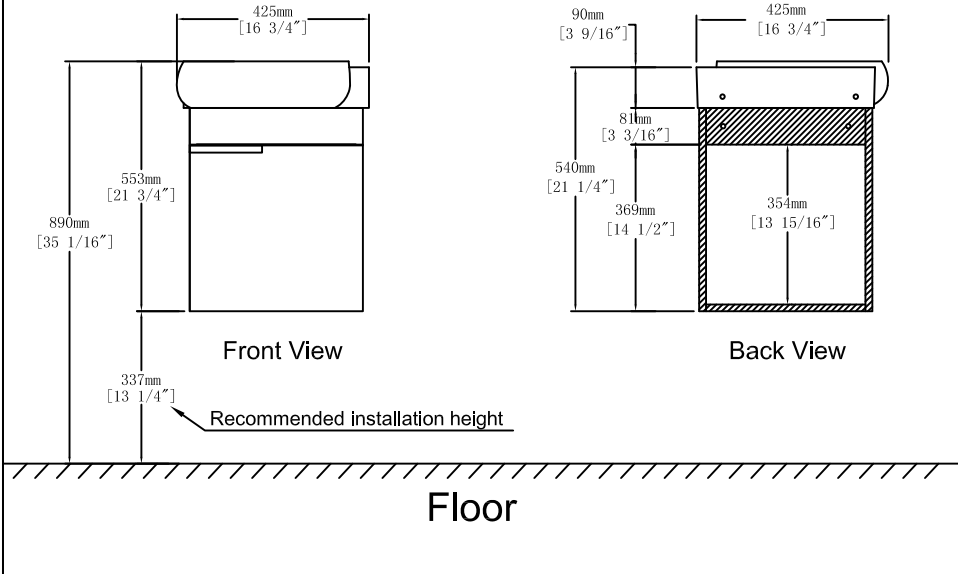

CARE CLEANING AND MAINTENANCE

1. Dust regularly with a soft , dry cloth.
2. Avoid the use of all chemicals household cleaners, abrasives, or cleaners that contain lemon, vinegar, or other acids that may damage the finish.
3. Excessive exposure to sunlight and extreme changes in temperature and moisture can damage wood furniture.
4. The sink top is resilient, but care needs to be taken to preserve its appearance.
5. Do not place hot appliances, such as curling irons and hot hair dryers directly on the countertop. Wipe spills immediately.