

**USER'S MANUAL**  
**Greenhouse**

THIS INSTRUCTION BOOKLET CONTAINS IMPORTANT SAFETY INFORMATION. PLEASE READ AND KEEP FOR FUTURE REFERENCE.

**Please give us a chance to make it right and do better!**

Contact our friendly customer service department for help first.

Replacements for missing or damaged parts will be shipped ASAP!

## Vor dem Beginnen

- ⚠ Bitte lesen Sie alle Anweisungen sorgfältig durch.
  - ⚠ Bewahren Sie die Anweisungen zum zukünftigen Verwendung auf.
  - ⚠ Separieren und zählen Sie alle Teile und Hardware.
  - ⚠ Lesen Sie jeden Schritt sorgfältig durch und befolgen Sie die richtige Reihenfolge.
  - ⚠ Wir empfehlen, wenn möglich, alle Artikel in der Nähe des Einsatzortes zu montieren, um ein unnötiges Bewegung des Artikels zu vermeiden.
  - ⚠ Stellen Sie den Artikel immer auf eine glatte, flache und stabile Oberfläche.
  - ⚠ Halten Sie alle kleinen Teile und Verpackungsmaterialien dieses Artikels von Babys und Kindern fern, da sie zur ernsthaften Erstickungsgefahr führen können.
- 

## Avant de Commencer









- ⚠ Veuillez lire attentivement toutes les instructions.
  - ⚠ Conservez les instructions pour la référence future.
  - ⚠ Séparez et comptez toutes les pièces et les outils de matériel.
  - ⚠ Lisez attentivement chaque étape et suivez le bon ordre.
  - ⚠ Nous recommandons que, si possible, tous les éléments soient assemblés à proximité de la zone dans laquelle ils seront utilisés, afin d'éviter de déplacer inutilement le produit une fois assemblé.
  - ⚠ Placez toujours le produit sur une surface plane, solide et stable.
  - ⚠ Gardez toutes les petites pièces et le matériel d'emballage de ce produit hors de portée des bébés et des enfants car ils pourraient provoquer un risque grave d'étouffement.
-

## Antes de Empezar





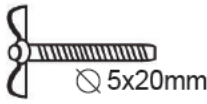

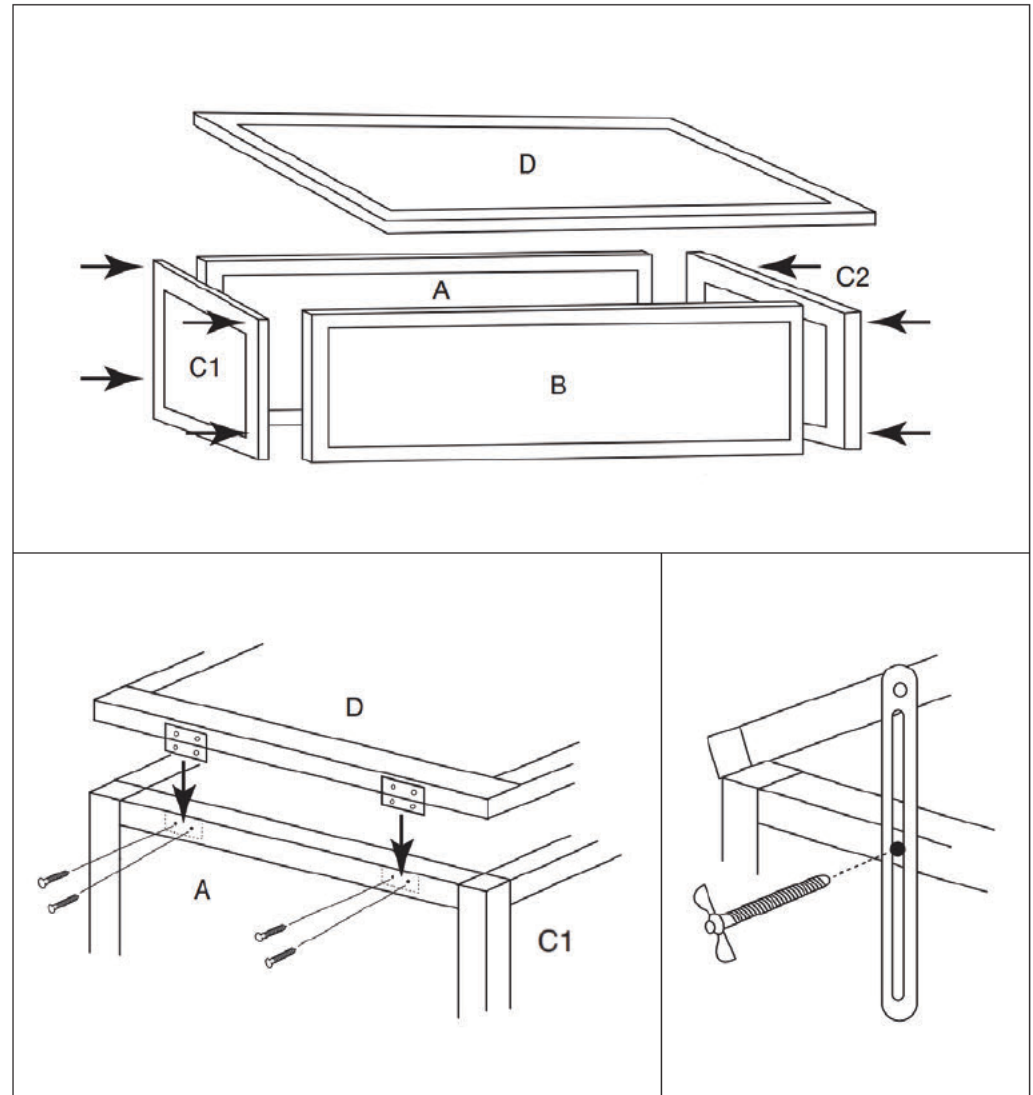

- ⚠ Por favor lea todas instrucciones con mucha atención.
- ⚠ Retenga instrucciones para referencias futuras.
- ⚠ Separe y cuente todas las piezas y accesorios.
- ⚠ Lea cada paso cuidadosamente y siga el orden correcto.
- ⚠ Recomendamos que, cuando sea posible, todos los artículos se armen cerca del área en la que se utilizarán, para evitar mover innecesariamente el producto cuando emsamble.
- ⚠ Siempre coloque el producto sobre una superficie plana, estable y firme.
- ⚠ Mantenga todas las piezas pequeñas y los materiales de embalaje de este producto lejos de los bebés y los niños, ya que representan un grave riesgo de asfixia potencialmente.

## Prima di iniziare





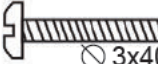

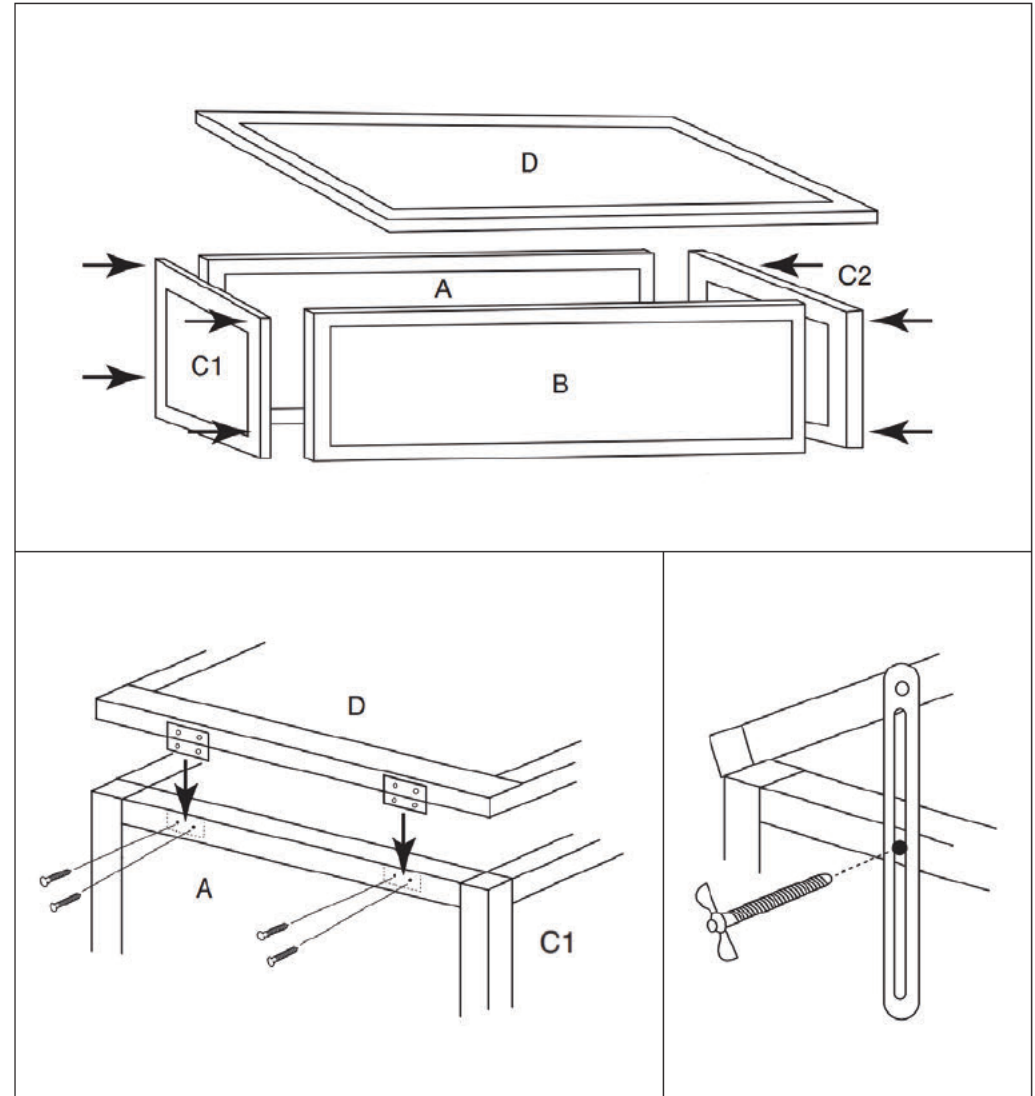

- ⚠ Si prega di leggere attentamente tutte le istruzioni.
- ⚠ Conservare le istruzioni per riferimento futuro.
- ⚠ Separare e contare tutte le parti e l'hardware.
- ⚠ Leggere attentamente ogni passaggio e segui l'ordine corretto.
- ⚠ Raccomandiamo che, ove possibile, tutti gli articoli siano assemblati vicino all'area in cui saranno collocati, per evitare di spostare il prodotto inutilmente una volta assemblato.
- ⚠ Posizionare sempre il prodotto su una superficie piana e stabile.
- ⚠ Conservare tutte le parti di piccole dimensioni e i materiali di imballaggio per questo prodotto lontano da neonati e bambini poiché potrebbero causare un serio rischio di soffocamento.

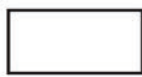
A	Back Panel		1
B	Front Panel		1
C1	Side Panel Left		1
C2	Side Panel Right		1
D	Lid Panel & Hinges		2
E	Lid Support Arms		1
F	Wing Bolt		1
H	Large Screws		8
I	Small Screws		4





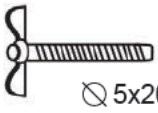
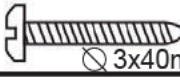



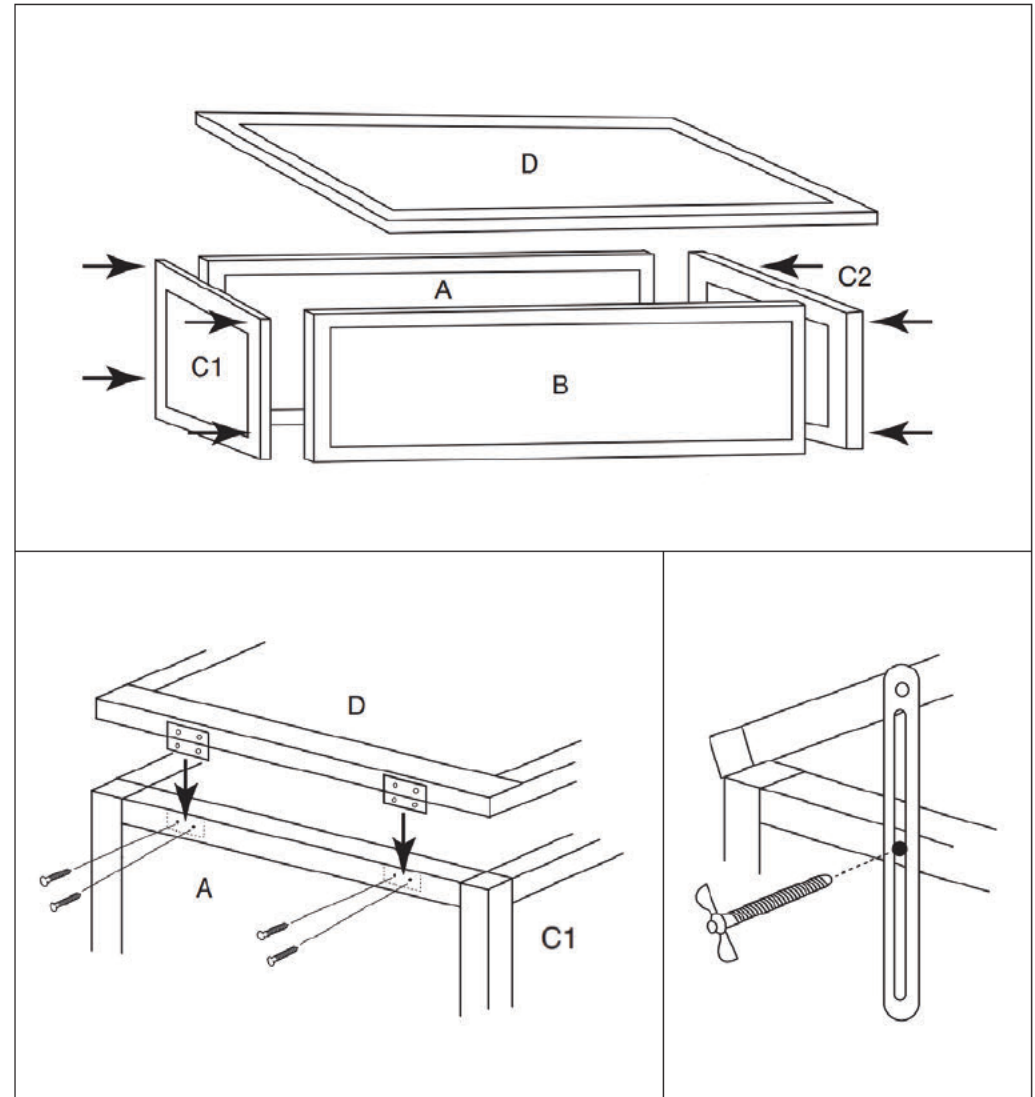

A	Rückseite Platte		1
B	Vorderseite Platte		1
C1	linke Seitenwand		1
C2	rechte Seitenwand		1
D	Deckelplatte mit Scharnieren		2
E	Deckelstützarme		1
F	Flügelschrauben	 Ø 5x20mm	1
H	große Schraube	 Ø 3x40mm	8
I	kleine Schraube	 Ø 2.5x10mm	4





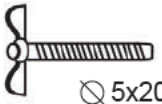
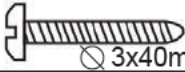



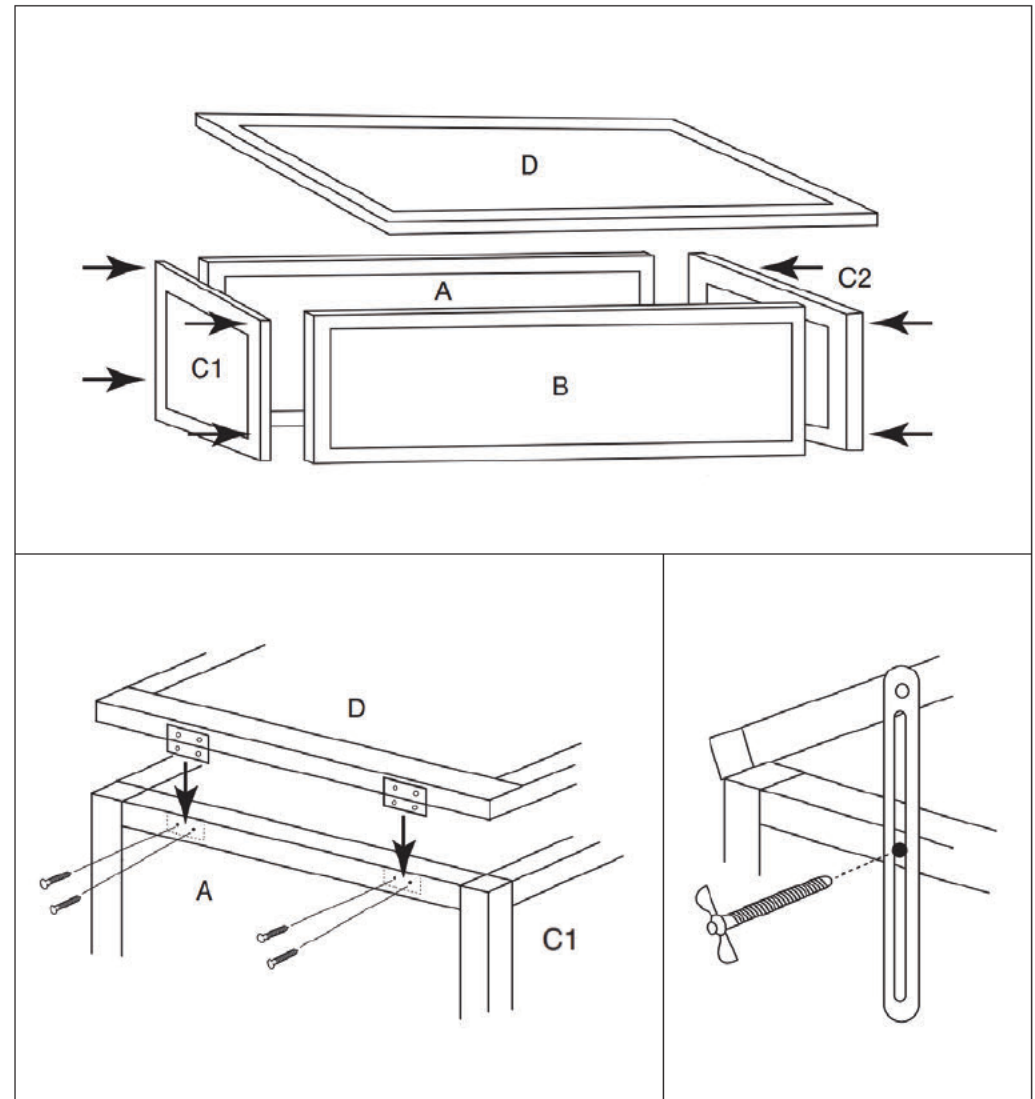

A	Plaque arrière		1
B	Plaque avant		1
C1	Plaque latérale gauche		1
C2	Plaque latérale droite		1
D	Plaque de couvercle avec charnières		2
E	Bras de support de couvercle		1
F	Boulon à ailettes	 Ø 5x20mm	1
H	Grandes vis	 Ø 3x40mm	8
I	Petites vis	 Ø 2.5x10mm	4



A	Panel frontal		1
B	Panel posterior		1
C1	Panel lateral izquierdo		1
C2	Panel lateral derecho		1
D	Bisagras de soporte de la tapa		2
E	Brazos de apoyo de tapa		1
F	Perno de ala	 ∅ 5x20mm	1
H	Tornillos grandes	 ∅ 3x40mm	8
I	Tornillos pequeños	 ∅ 2,5x10mm	4



A	Pannello posteriore		1
B	Pannello frontale		1
C1	Pannello laterale sinistro		1
C2	Pannello laterale destro		1
D	Pannello del coperchio e cerniere		2
E	Bracci di supporto del coperchio		1
F	Bullone ad alette	 Ø 5x20mm	1
H	Viti grandi	 Ø 3x40mm	8
I	Viti piccole	 Ø 2.5x10mm	4

