

**ISLiFe**

# S Style Sliding Barn Door

Instruction for assembling

Contact Us: [info@islifeusa.com](mailto:info@islifeusa.com)

Website: [www.islifeusa.com](http://www.islifeusa.com)



IsLife

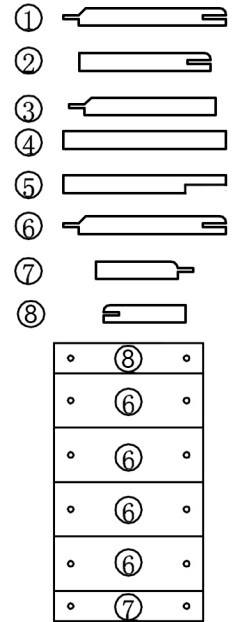
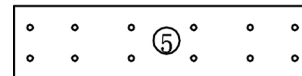
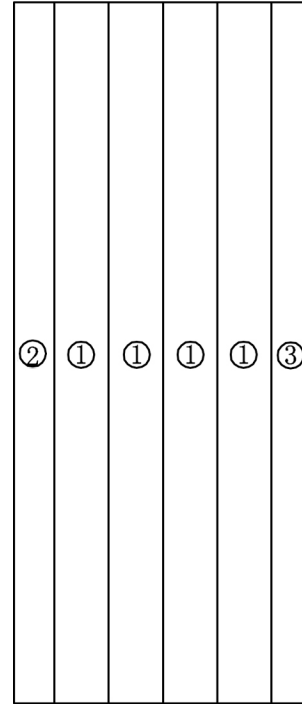
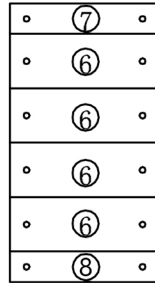
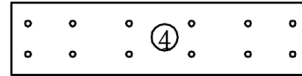
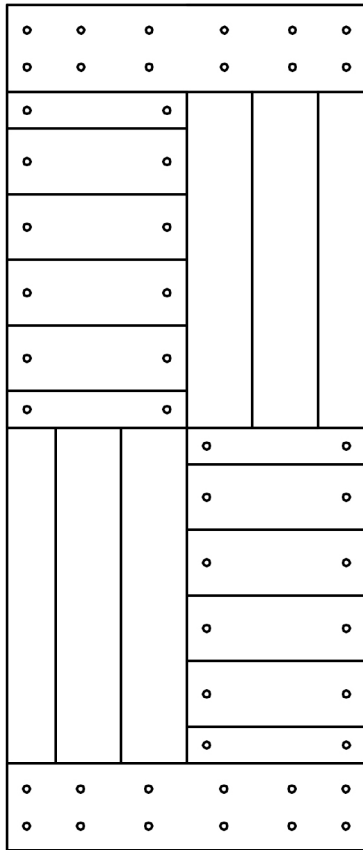

Avoid direct sunlight

Avoid moisture

Avoid rain

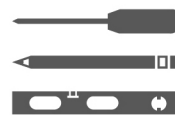
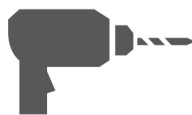





Tools Required

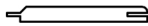
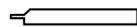

- Two-person assembly recommended
- Wear work gloves

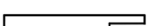
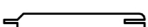
## Sliding Barn Door Includes:

Board number/Side View	size/pieces	size/pieces	size/pieces	size/pieces	size/pieces	size/pieces
	24in. Wx84in. H	28in. Wx84in. H	30in. Wx84in. H	36in. Wx84in. H	38in. Wx84in. H	42in. Wx84in. H
1# 	2	3	3	4	4	5
2# 	1	1	1	1	1	1
3# 	1	1	1	1	1	1
4# 	1	1	1	1	1	1
5# 	1	1	1	1	1	1
6# 	8	8	8	8	8	8
7# 	2	2	2	2	2	2
8# 	2	2	2	2	2	2
Hardware Track	5FTx1	5FTx1	5FTx1	6.6FTx1	6.6FTx1	8FTx1
Screws	40	44	44	48	48	52

### Installation Tips:

1. Ensure all panels are installed with the 45-degree angled surface facing upward.
2. Ensure that the groove on panel #5 is facing inside.
3. For detailed steps on installing the hardware kit, refer to the installation guide included in the hardware kit package.
4. Screws holes are not pre-drilled for the rail. When you install the track, you need to drill holes on the door.
5. Our barn doors are handmade, and there may be a 1/8 inch variation in total length may occur. If needed, adjust panels #6, #7, and #8 during installation to compensate for the required length.
6. Please contact us if you have any questions at [info@islifeusa.com](mailto:info@islifeusa.com).

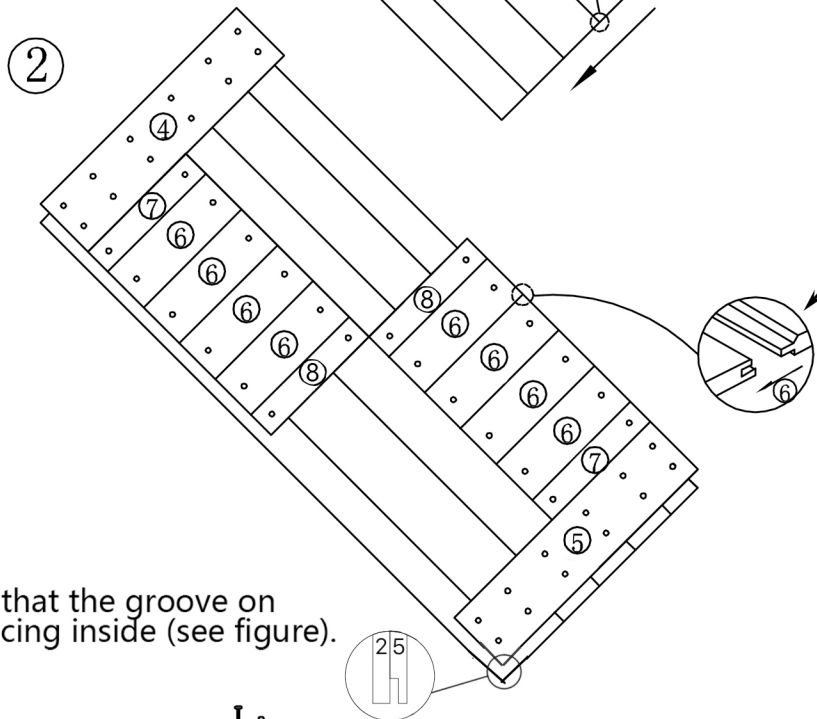
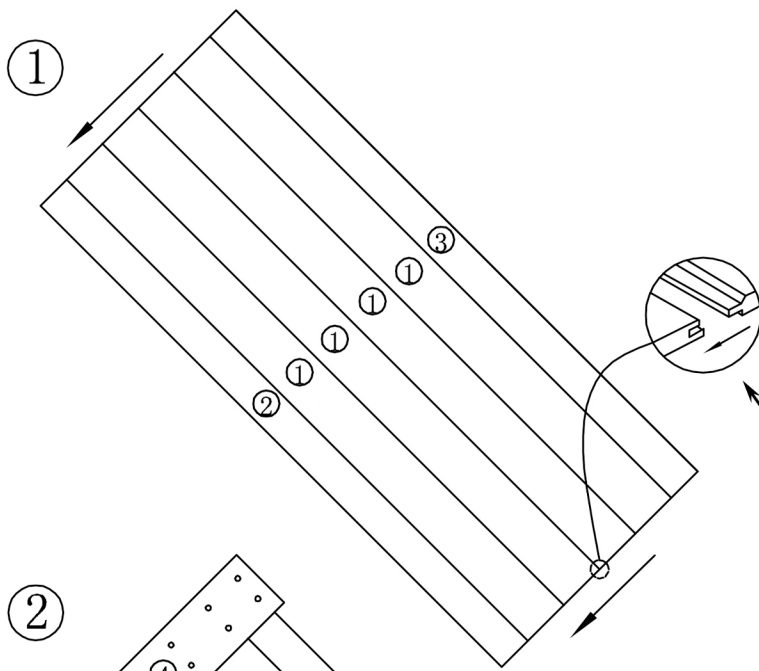

Ensure all panels are installed with the 45-degree angled surface facing upward.

Note: Ensure that the groove on panel #5 is facing inside (see figure).

