

Installation manual

Dimensions:L24" W14 "H18" L6

Bulb Type:E12 bulb not included

Lamp Frame Weight(lbs):7.6

Total Weight(lbs):27



Thank you for choosing our product(s).

Our Company is actively involved in every step of the production.

Our product(s) are designed to be utilized for every application that graces your home or business.

We pride ourselves in providing the most prompt and courtesy service to all of the valued customers.

Please find the enclosed detailed instruction and read carefully for proper installation.

If you have any questions, our professional customer service team is committed to assisting you, please call our toll free HOTLINE



D24" 14" H18" L6

SAFETY

Warning: MAKE SURE THE ELECTRICITY TO THE WIRES YOU ARE WORKING ON IS SHUT OFF. BY EITHER REMOVING THE FUSE OR TURNING OFF THE CIRCUIT BREAKER.

CAUTION

- Before assembling the lighting fixture, please read all instructions carefully.
- All frame & crystal components are fragile, please handle with care.
- Required supply circuit : 110 - 130V/60Hz
- Labeled wires are "L" for live wire, "N" for neutral wire, "E" for ground wire.
- Never install fixture on damp ceiling, the room should be dry and well ventilated
- All electrical components must be installed by a licensed electrician and in accordance with the National Electrical Code and the appropriate local electrical codes.

Unpack the Package

Please open the box carefully and check all the items are inside the box. If you have any installation, assembling and missing parts questions, please call our Customer Service department Please have model number(at the front page), where you purchase from and any other relevant information ready, our customer service team will provide comprehensive and worry free service to our valued customers.

01

D24" 14" H18" L6

Frame Parts List

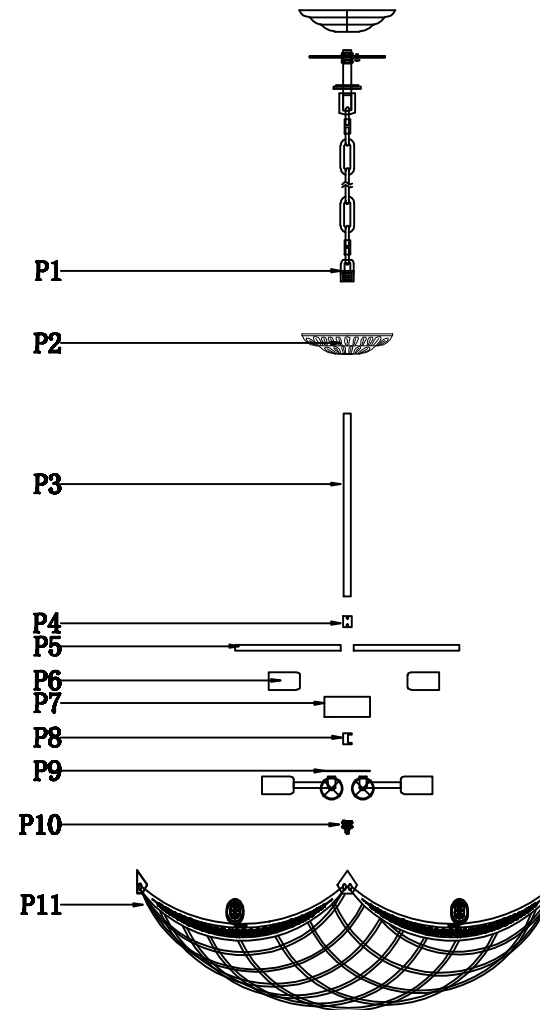











02

D24" 14" H18" L6

Step 1











Please use the parts list to ensure you are not missing any parts

PARTS LIST

part	picture	Description	Qty	Check list
ZA		4" Mounting bracket	1	
ZB		5.3" Canopy cover	1	
ZC		Canopy ring	1	
ZD		L59" Twist Design	1	
ZE		Power Cord 12' SPT-1-16# Clear/Gold	1	
P1		Loop	1	
P2		6" Canopy ceiling	1	
P3		9.8" Both end Threaded pipe	1	
P4		Coupling	1	
P5		10.4" Iron bracket	4	
P6		E12 Lampholder	6	

03

D24" 14" H18" L6

part	picture	Description	Qty	Check list
P7		3" Metal wire box	1	
P8		Hickey	1	
P9		3" Metal plate	1	
P10		Finial	1	
P11		24" Lamp body	1	
A		701-40#	4	
B		873-38#	4	
C		701-40#	81	
D		1050-12#*5+10#*4+8#*4+6#*3	8	
E1		1502-10#*28	2	
E2		1502-10#*37	2	

04

D24" 14" H18" L6

Step 2

Canopy Installation Instruction

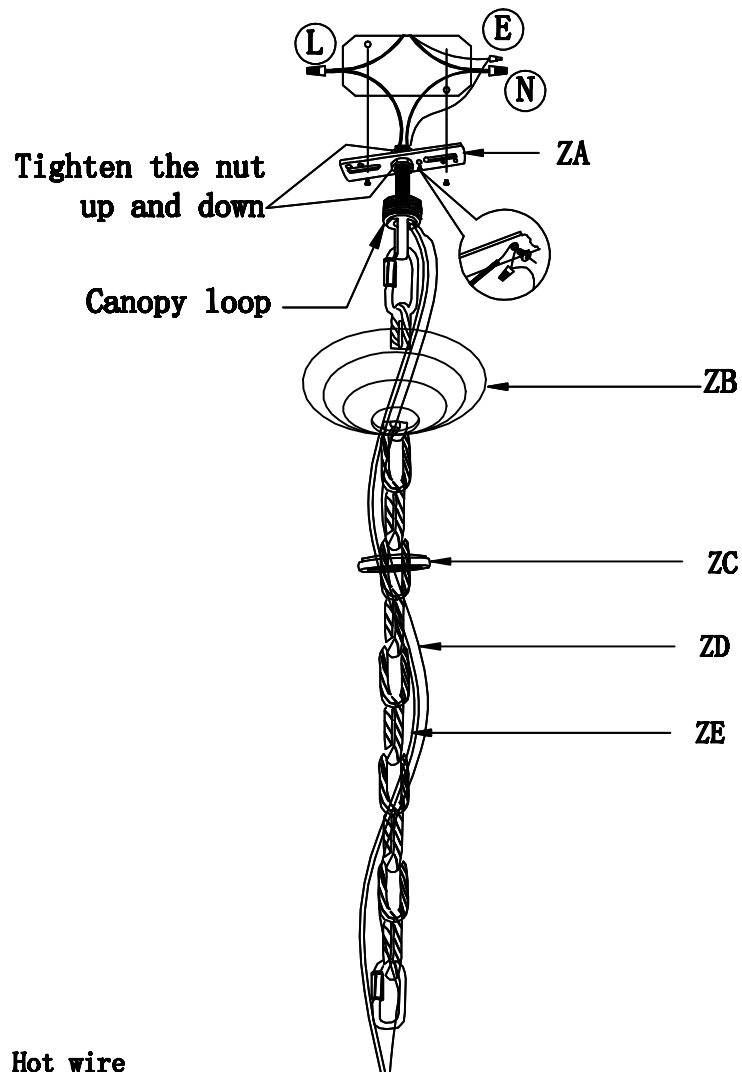

"L" = Hot wire
"N" = Neutral wire
"E" = Ground wire

05

D24" 14" H18" L6

IMPORTANT: Test sockets with bulb before dressing the fixture.

1. Attach the crossbar to the electrical box.
2. Pass the lamp wire and ground wire through the loop, canopy ring and center hole of canopy cover.
3. Screw 2.5" threaded pipe into the crossbar and fasten with hex-nut.
4. Pull wires up through the nipple.
5. Screw loop only onto threaded pipe.
6. Hang the fixture on chain.
7. Make the electrical connections as detailed in the drawing above.
8. Secure the canopy cover with threaded canopy ring

06

D24" 14" H18" L6

Frame Assembly Diagram

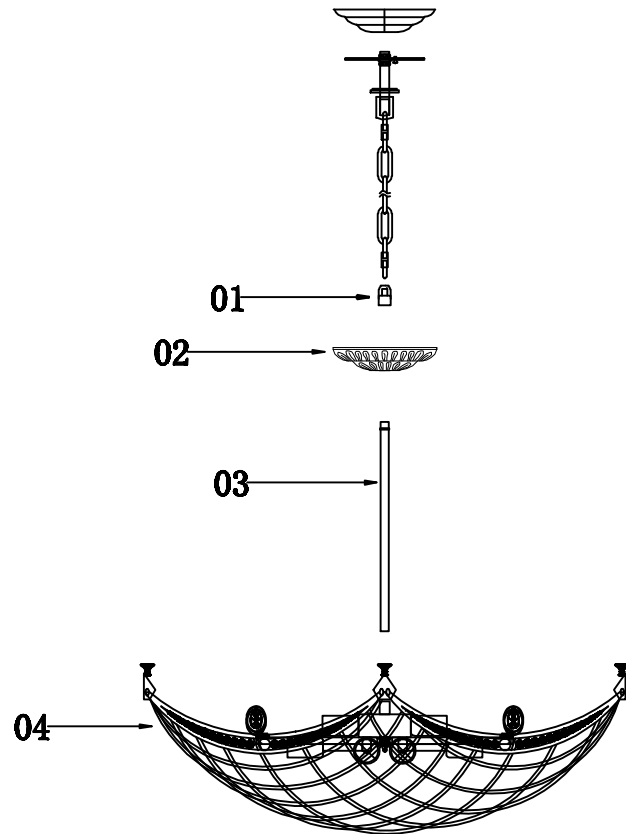

07

D24" 14" H18" L6
Step 3

Frame Assembly Instructions

Installation:

Please read all instructions carefully.

Before you proceed to install, make sure

that the power supply is turned off and

remains off until installation is complete.

Please note that each part has been assigned a number.

Please proceed in a numerical order.

1. Put the bottom tier (04) main wire through the threaded pipe (03).
2. Put the iron plate (02) through threaded pipe (03), screw it with chain (01), then hang it on the ceiling.
3. Connect the main wire with the positive and negative of 4" Junction box are correct.
4. As the crystal pressing instruction, hang the crystal parts.

The end!

08

D24" 14" H18" L6

Step 4 Crystal Dressing Instructions

1. Hang crystal "A""B""C""D""E"

09

D24" 14" H18" L6

Crystal Dressing Diagram



When dressing the chandelier with the crystals please remember to wear either rubber or cotton gloves. So as to prevent any damage or smudging on the crystals.

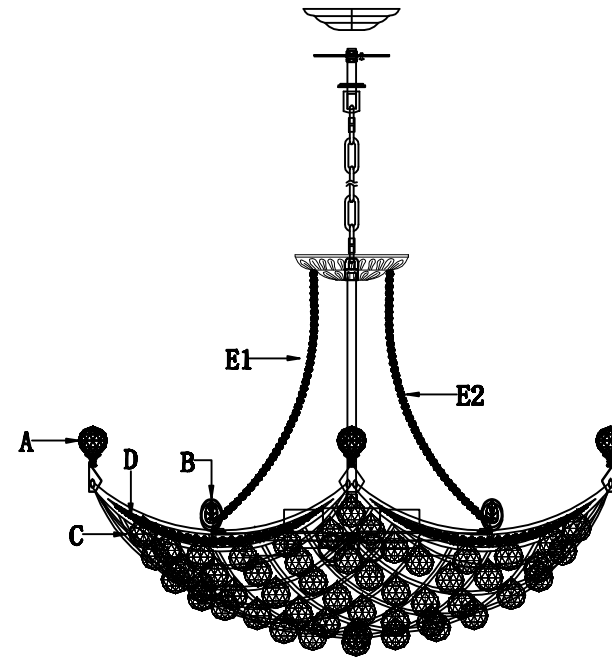

10

Congratulations !

You are now done installing your fixture. Sit back and admire each crystal as it will become the statement piece for your room/house.

If you require any additional assistance, please contact us

Thank you.

Cleaning and Maintenance of Chandelier Frame

The finish on our chandelier frames and fixture frames is protected by a durable coating of lacquer. To clean, use a clean, soft, dry cloth. Do not use any metal polishes, cleaners, abrasives or any substance which could remove the protective finish. Failure to follow these instructions automatically voids the guarantee.

Cleaning and Maintenance of Crystals

Wet a soft cotton fabric in clean warm water and wipe gently, then polish with a dry soft cotton fabric.

To Order Crystal Replacement Parts

Should you require replacement crystals or pins (the metal connectors attaching the crystals), contact the store where the product was purchased or contact us at the address shown on the reverse side. For ease of ordering, you may use the original crystal trimming instructions provided with this product and circle the items you wish to order, indicating the quantity by writing the number needed adjacent to the circle and faxing it to our customer service department. You will be contacted with prices prior to shipment. All orders must be pre-paid.

Warranty

The finish and frame of your new chandelier or fixture are warranted for a period of two(2) years from the date of purchase. Our company will at its option, repair or replace any frame that has a defect in the material or workmanship during the warranty period. All crystals are guaranteed for their original quality during the life of the chandelier. Breakage is not covered by this warranty.

To make a claim under this warranty, contact our customer service department at the address and phone number shown below. A written return authorization form will be sent to you with specific instructions.

Returns and Conditions of Warranty

Returns must be pre-authorized by contacting our customer service department at the address on the reverse side. Returns will only be accepted with a written return merchandise authorization and return shipping charges pre-paid. We reserve the right to inspect all returned merchandise to fully determine the nature of any defect. This guarantee shall not apply to any product that has been changed, altered or otherwise modified, nor shall it apply to any product that has been repaired or altered by anyone other than a pre-authorized facility. We will not be responsible for any breakage or damages incurred during transit, nor for crystal parts or metal frame part that have been subject to misuse, negligence, accident or inappropriate handling. Also, we will not be held responsible for damage incurred during improper installation or wiring by others, nor for damages resulting from a failure to follow the recommended maintenance or installation procedures. This guarantee is issued in lieu of any and all other guaranteed or warranty, whether written or implied and any and all other obligations or liabilities. Further, we neither authorize nor permit any other person or firm to assume for us, any liability in connection with the sale of our products.