

①

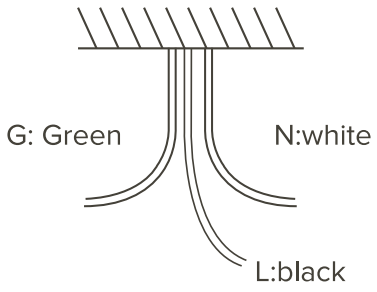

②

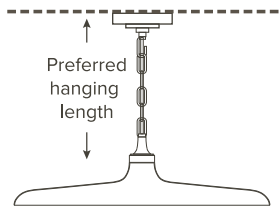

③

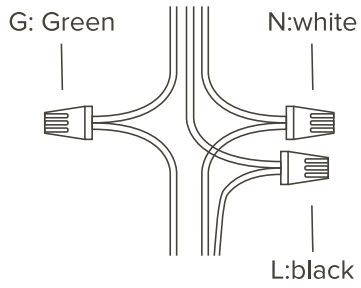

④

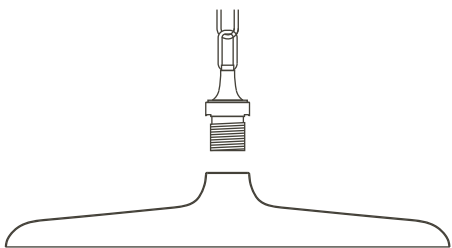

⑤

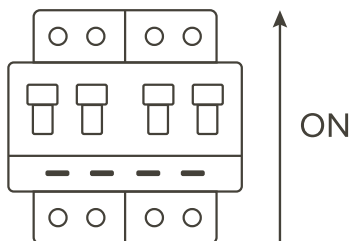

⑥

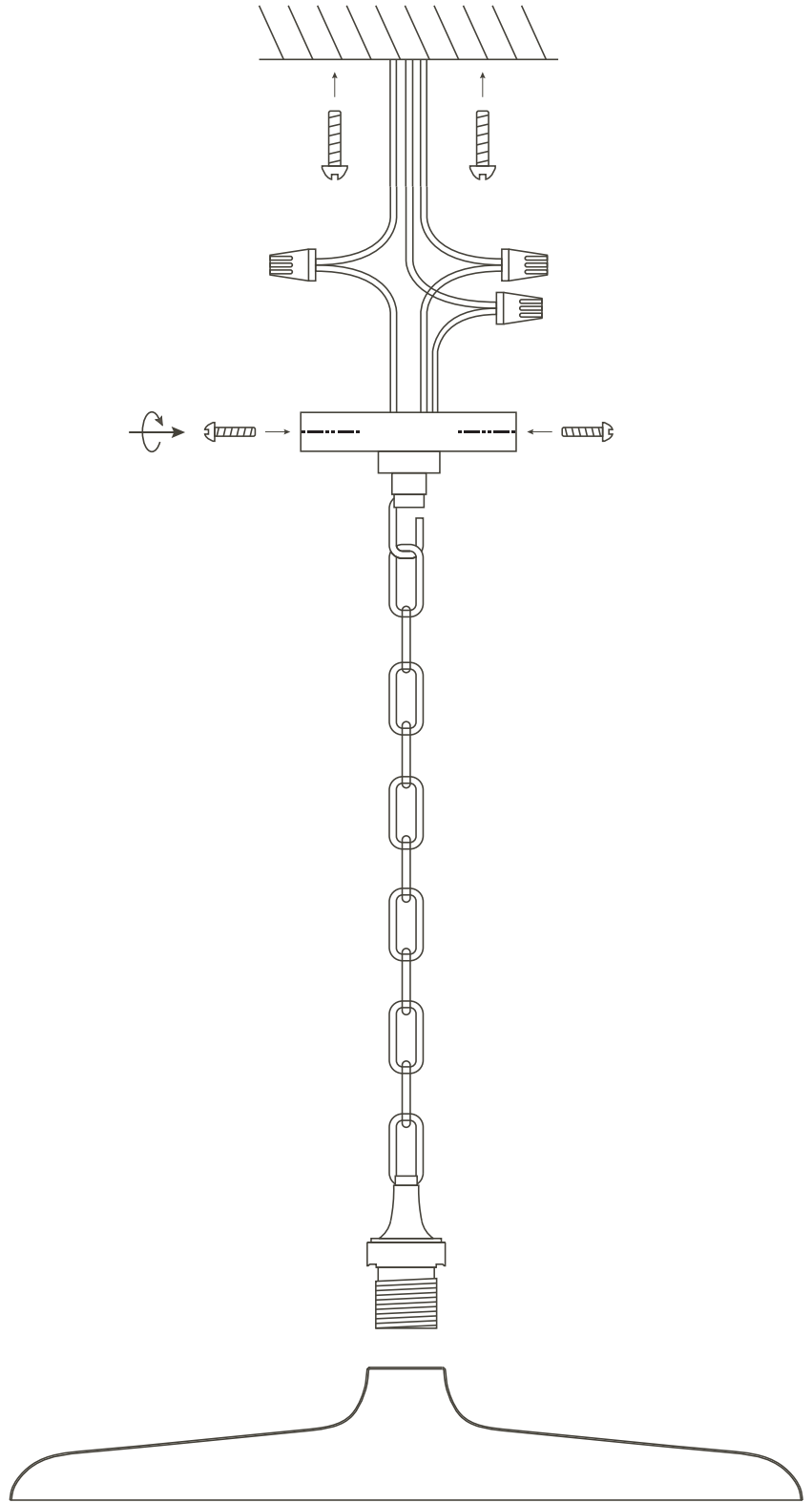

E26 Max40W Not included

# Natalia Pendant Light Instruction

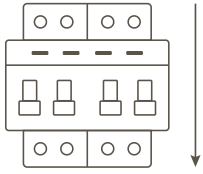

## Step 1: Preparation

- Ensure the power is turned off at the breaker. To double-check, turn the wall switch to "ON" and use a voltage tester, or confirm that no lights turn on in the room.
- If replacing an old fixture, remove the existing light, exposing the electrical junction box in the ceiling.

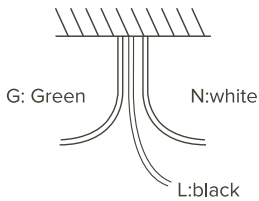

## Step 2: Identify the Ceiling Wires

- Locate and identify the wires in your ceiling:
  - Black – Live/Hot (L)
  - White – Neutral (N)
  - Green or bare copper – Ground (G)

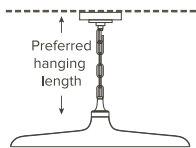

## Step 3: Adjust the Chain

- Measure your desired hanging height and adjust the chain length accordingly by removing any extra links.
- Make sure to leave enough wire length to reach the junction box for wiring.

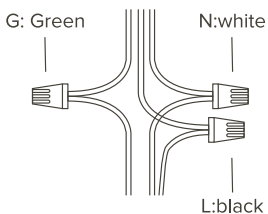

## Step 4: Connect the Wires

- Using the provided wire nuts, connect the fixture wires to the ceiling wires as follows:
  - Black fixture wire → Black ceiling wire (L – Live)
  - White fixture wire → White ceiling wire (N – Neutral)
  - Green or bare copper fixture wire → Green or bare ceiling wire (G – Ground)
- Double-check that all wire connections are tight and properly capped with wire connectors.

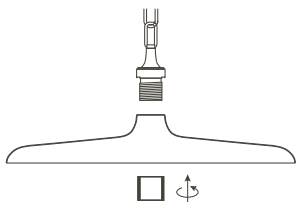

## Step 5: Mount the Lampshade

- Place the lampshade in position and secure it using the provided mounting ring or lock ring.

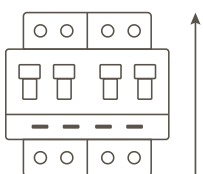

## Completion:

- Restore power at the breaker panel and test your new pendant light by turning on the wall switch.