

# ASSEMBLY INSTRUCTIONS

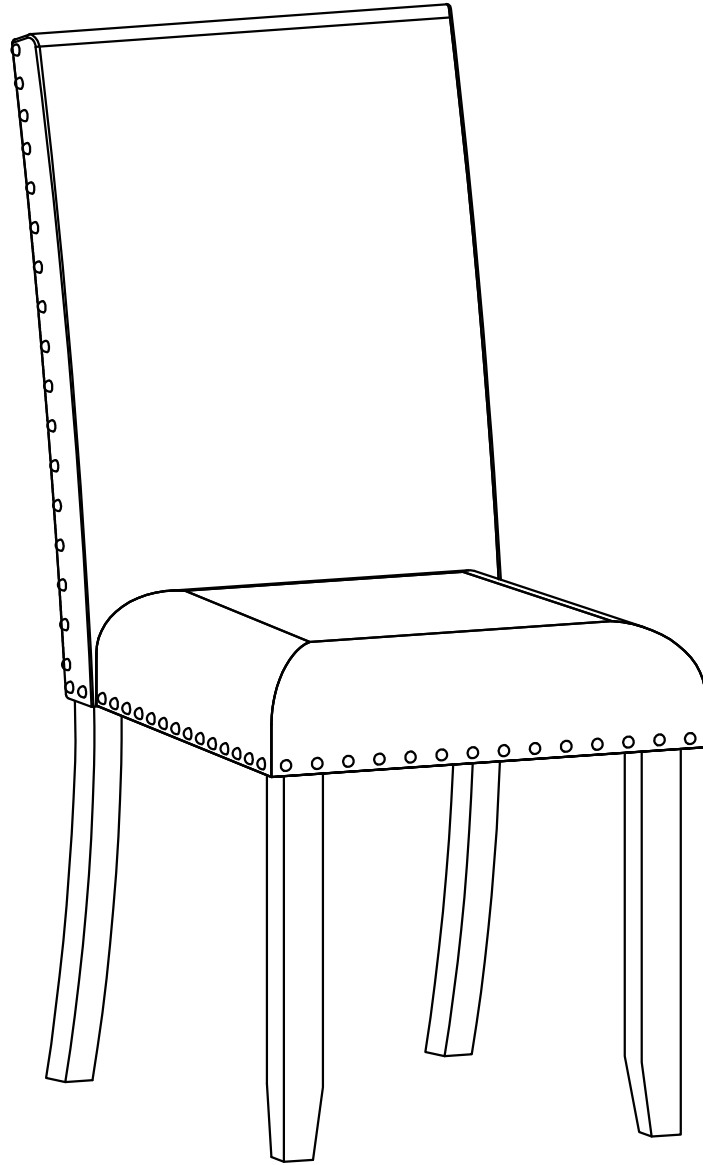

**IMPORTANT NOTE :**

- ① PLACE ALL PARTS ON A CLEAN AND SMOOTH SURFACE SUCH AS A RUG OR CARPET TO AVOID THE PARTS FROM BEING SCRATCHED.
- ② BEFORE YOU BEGIN, KINDLY FOLLOW THE ASSEMBLY INSTRUCTIONS STEP BY STEP.
- ③ DO NOT TIGHTEN ALL SCREWS AND BOLTS UNTIL THE CHAIR IS FULLY SET-UP.

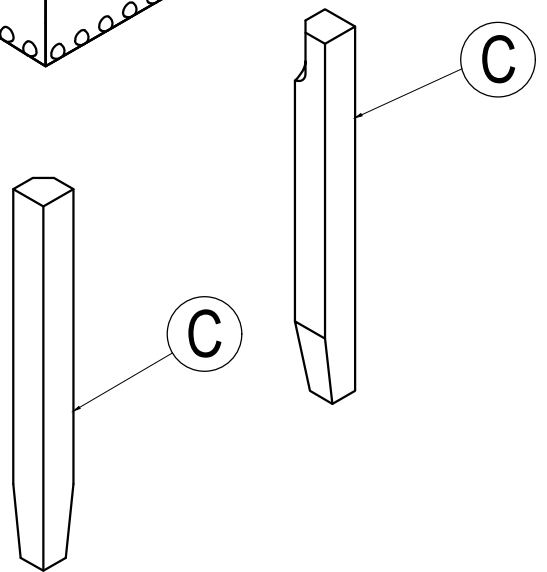
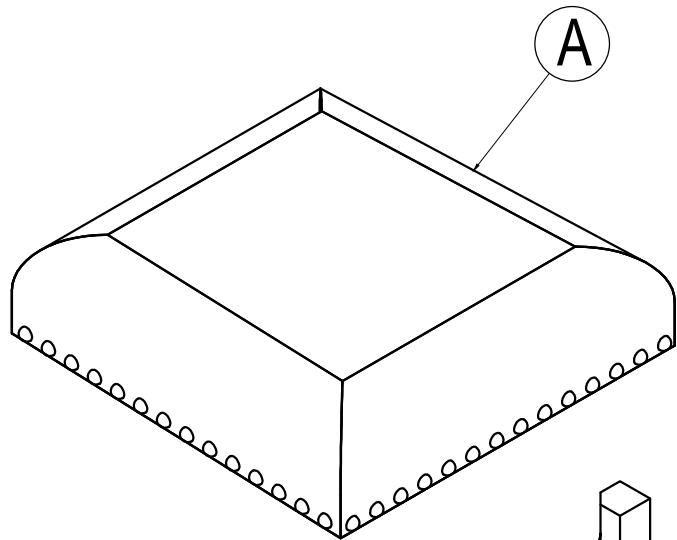
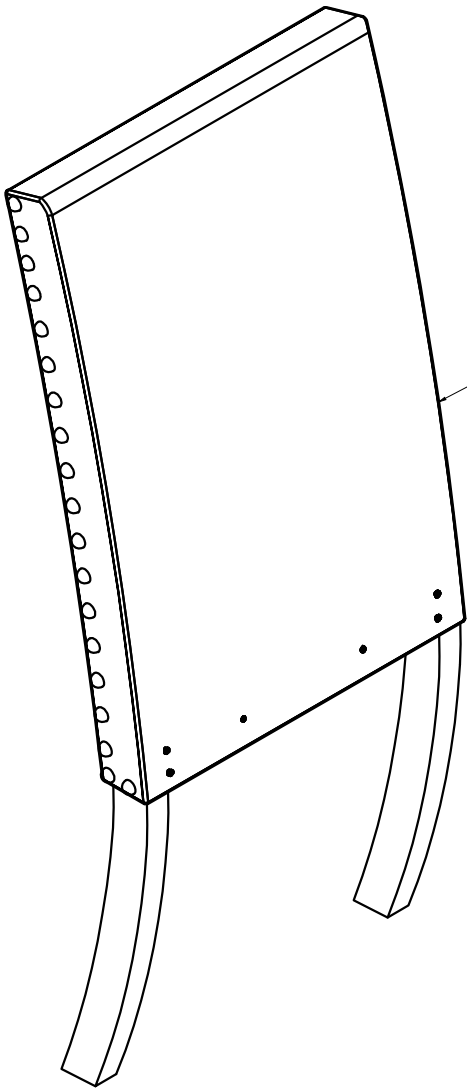

# Part List

# Hardware List

(A)

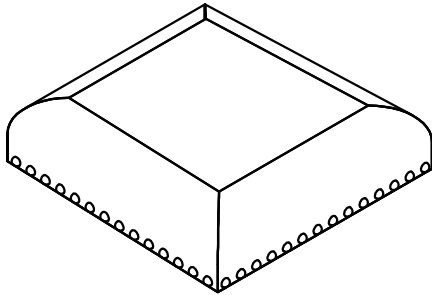

SEAT CHAIR (4pcs)

(B)

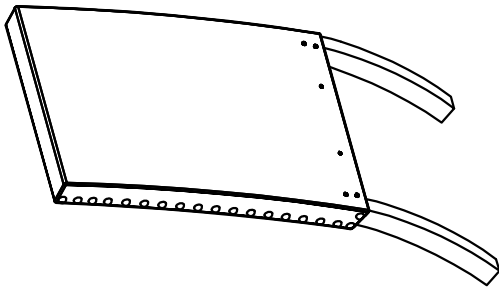

BACK CHAIR (4pcs)

(C)

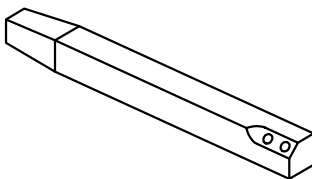

LEG FRONT (8pcs)

①

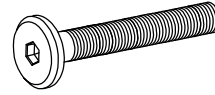

Ø 1/4" x 45mm

BOLT (24pcs)

②

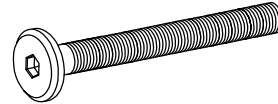

Ø 1/4" x 75mm

BOLT (16pcs)

③



Ø5/16" x 13mm

FLAT WASHER (40pcs)

④



Ø5/16" x 19mm

LOCK WASHER (40pcs)

⑤



4mm

ALLEN KEY (1pc)

# STEP 1

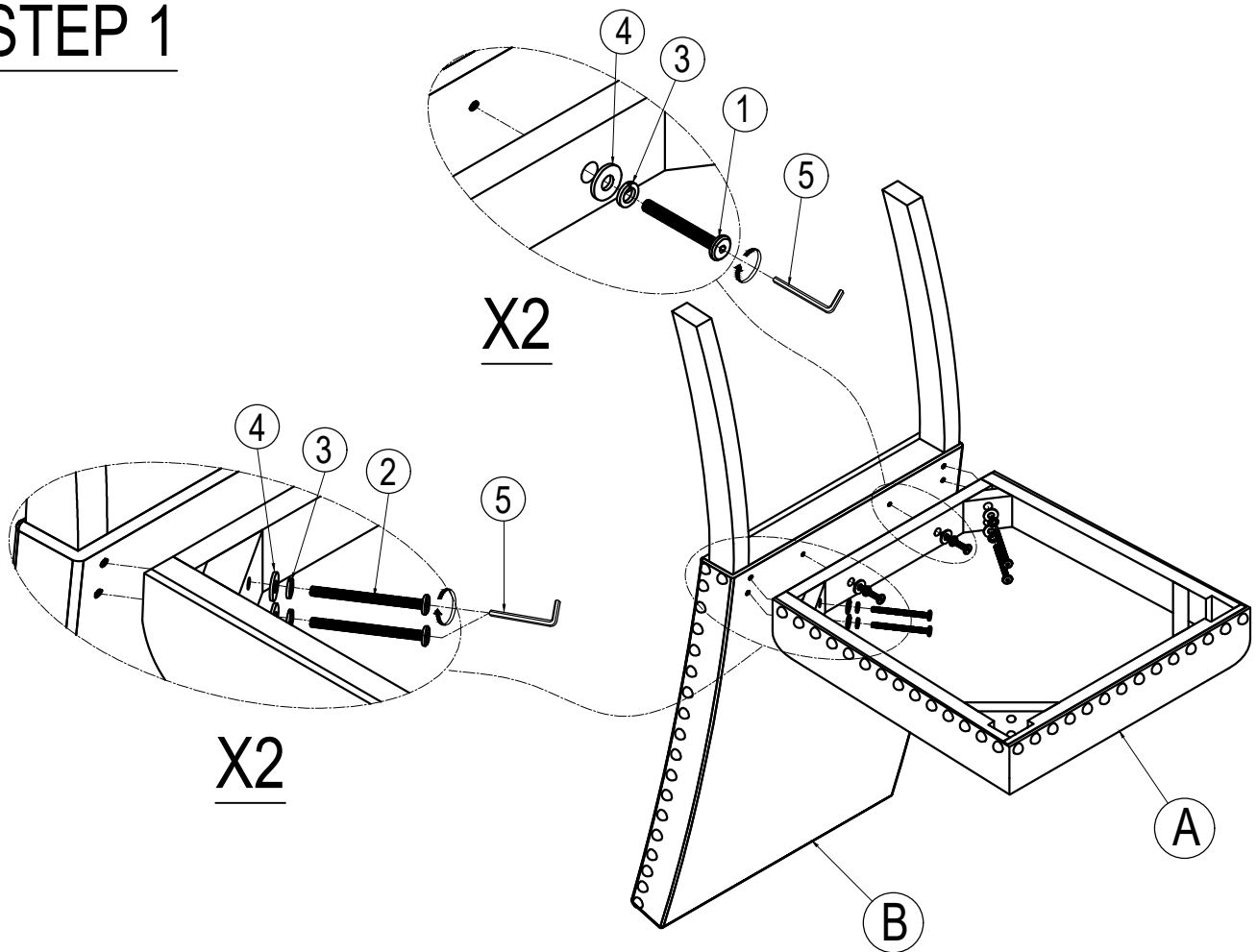

# STEP 2

